

ARS PÓLSZAFKA

WERSJA -L

WERSJA -R

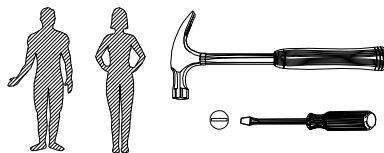

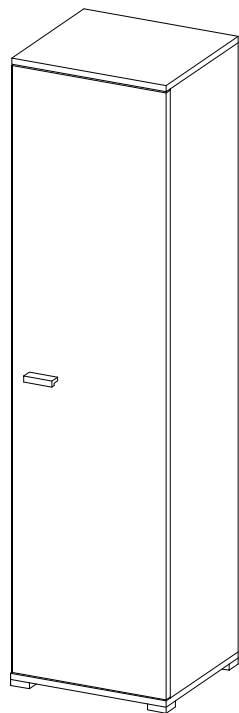
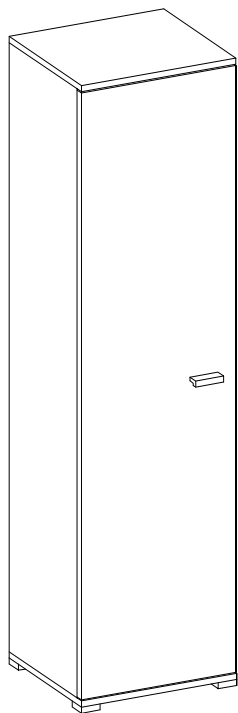

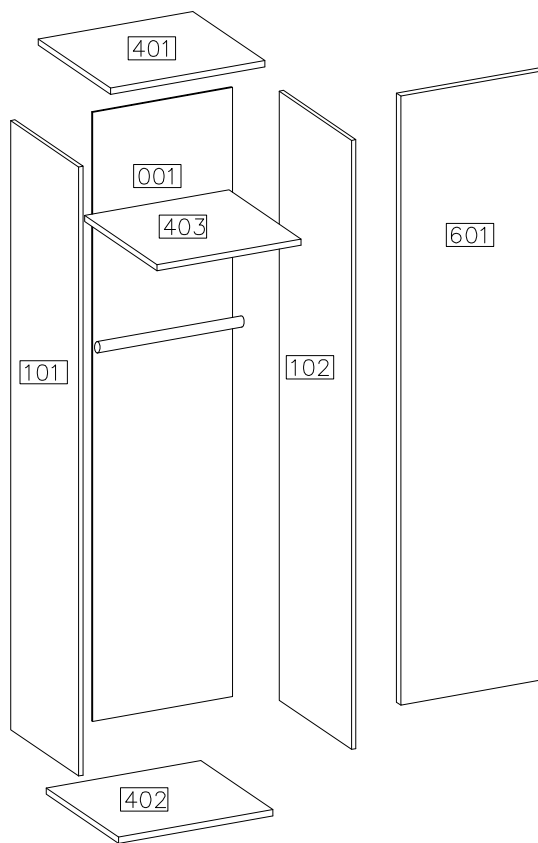
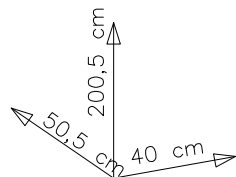
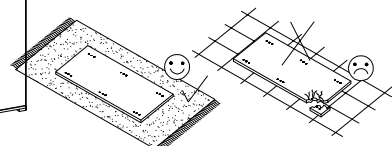
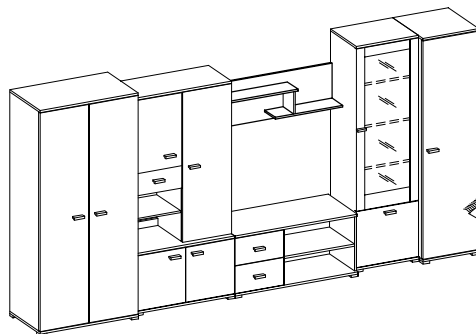
#	ART. NR	QUANTITY
1	401	1
2	402	1
3	403	1
4	101	1
5	102	1
6	001	1
7	601	1

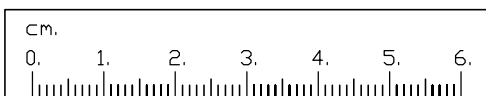

D1	$\varnothing 15/12\text{mm}$ C	$\varnothing 8 \times 30\text{mm}$ A	E	$4.0 \times 35\text{mm}$ R3	F4	F10	S1	$4.0 \times 27\text{mm}$ R2
12	12	18	12	8	4	50	1	2
O10	O12	$\varnothing 4.0 \times 16\text{mm}$ P1	$\varnothing 35 / \text{KR}-0$ G6	H=0 H4	$3.5 \times 13\text{mm}$ P2			
2	1	6	3	3	4			

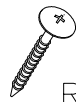

1

4.0x35mm		
	R3	F4
8		4

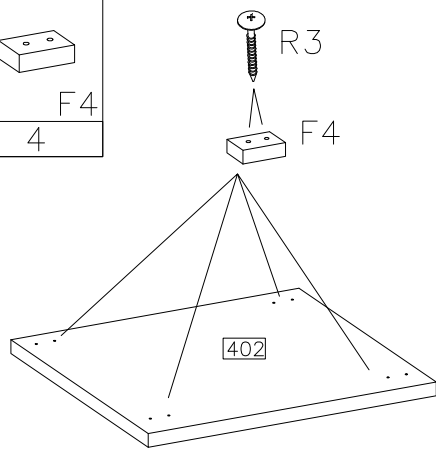

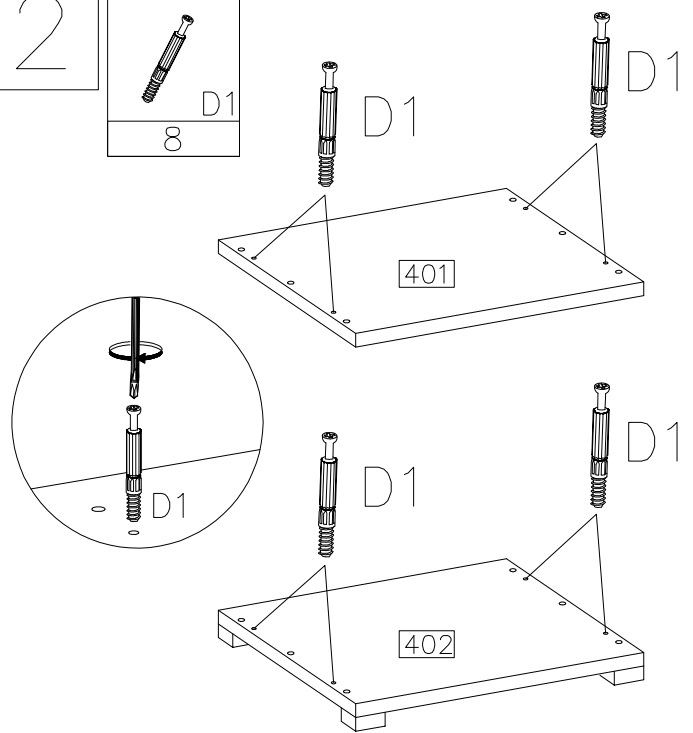

2

	D1
8	





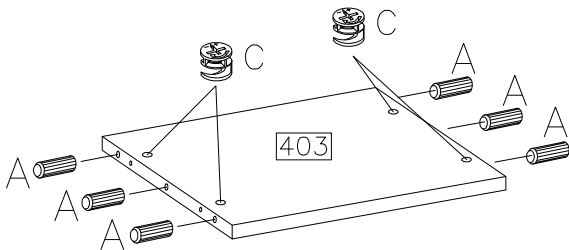
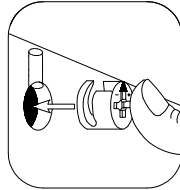

3

$\varnothing 15/12\text{mm}$	$\varnothing 8 \times 30\text{mm}$
	
C	A
4	6



4

	$\varnothing 8 \times 30\text{mm}$
D1	A
4	12
	H=0
O10	H4
2	3
$\varnothing 15/12\text{mm}$	3.5x13mm
	
C	P2
8	4

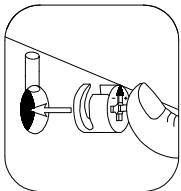
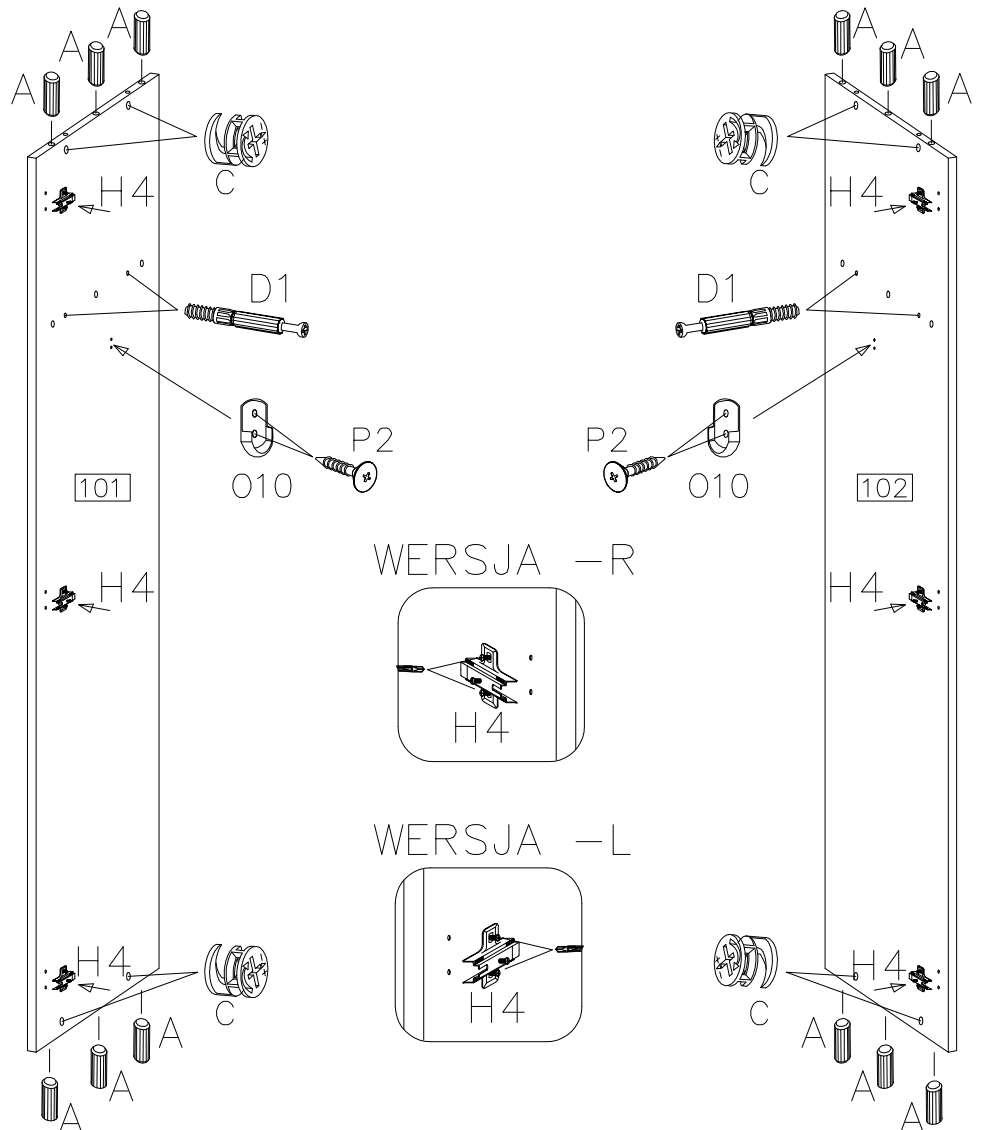

5

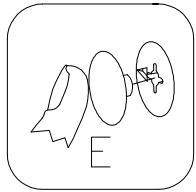
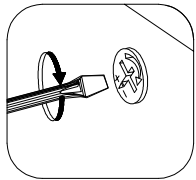
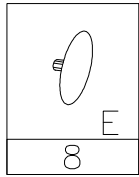

2

1

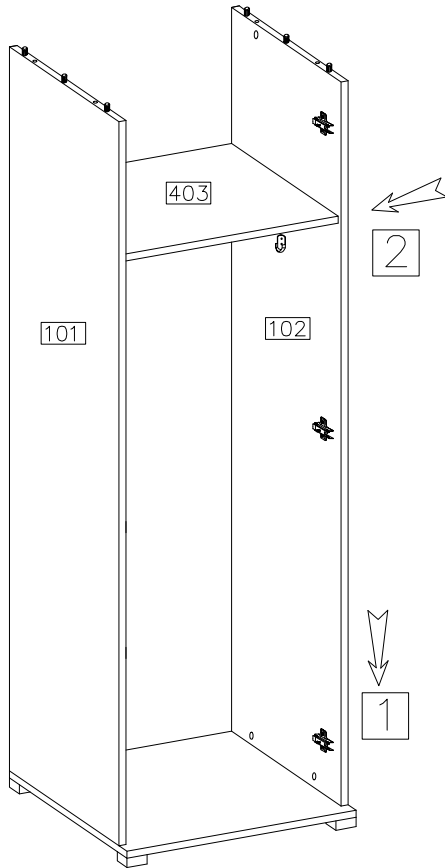

6

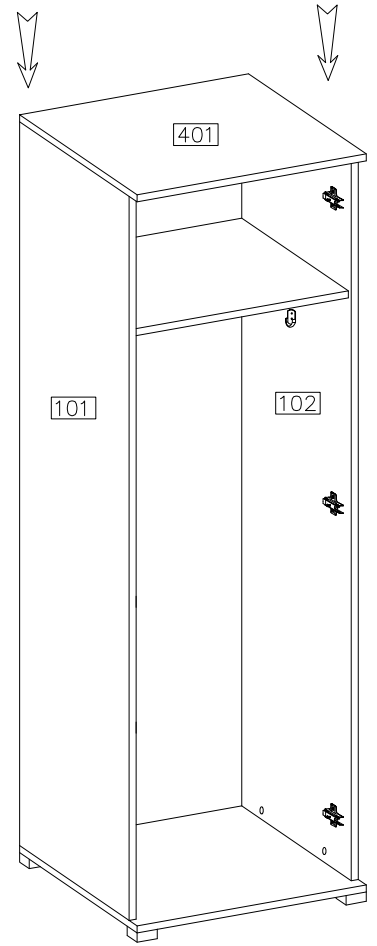
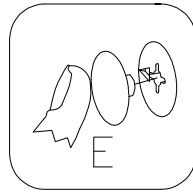
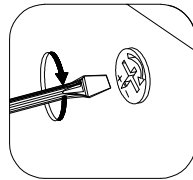
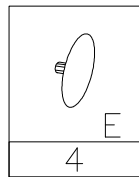

7

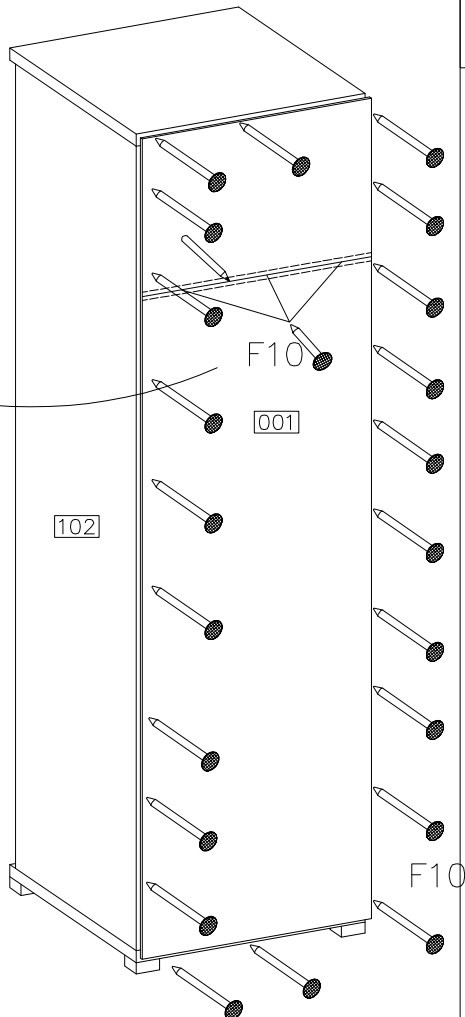
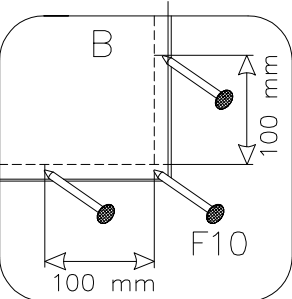
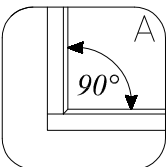
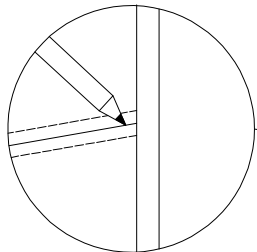
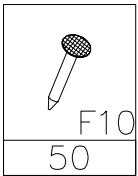



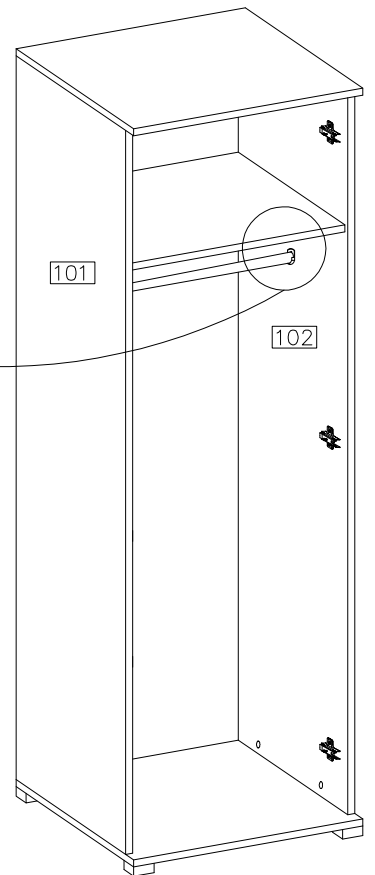
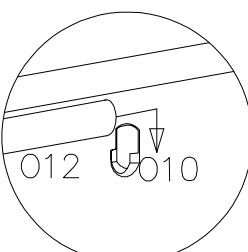
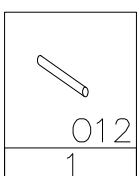

8



WERSJA -L

WERSJA -R

4.0x27mm

R2
2

S1
1
ø35/KR-0

G6
3
ø4.0x16mm

P1
6

