

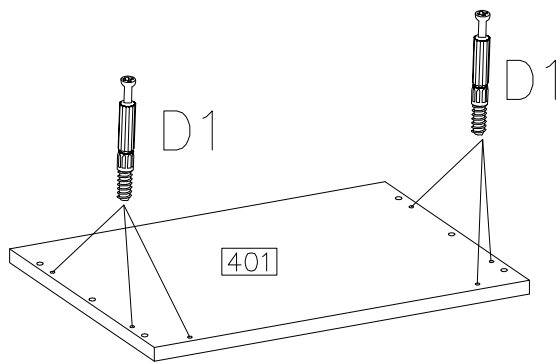

1

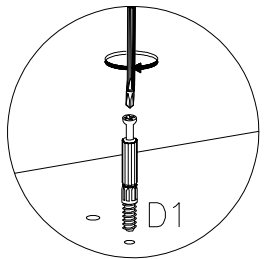

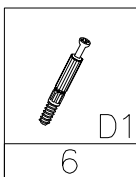
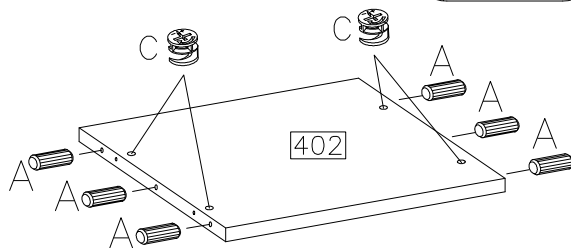
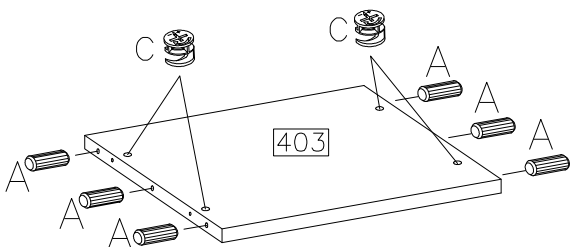
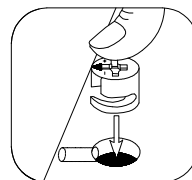
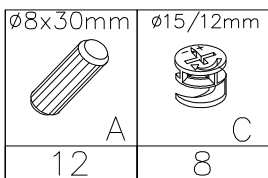

2

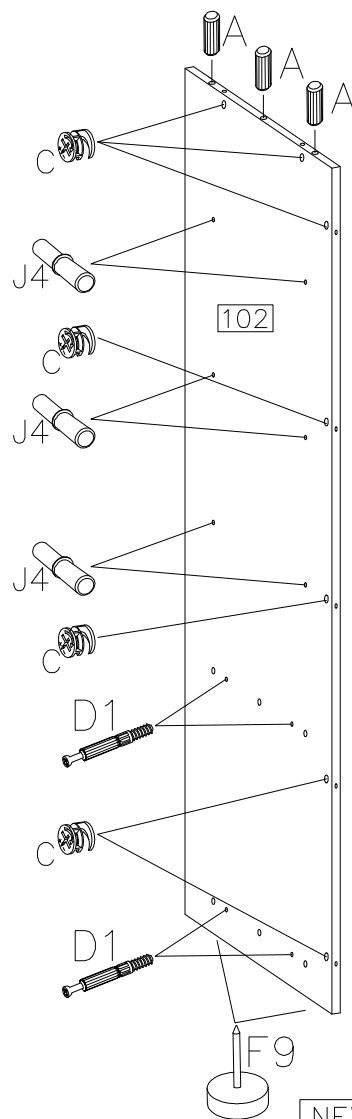
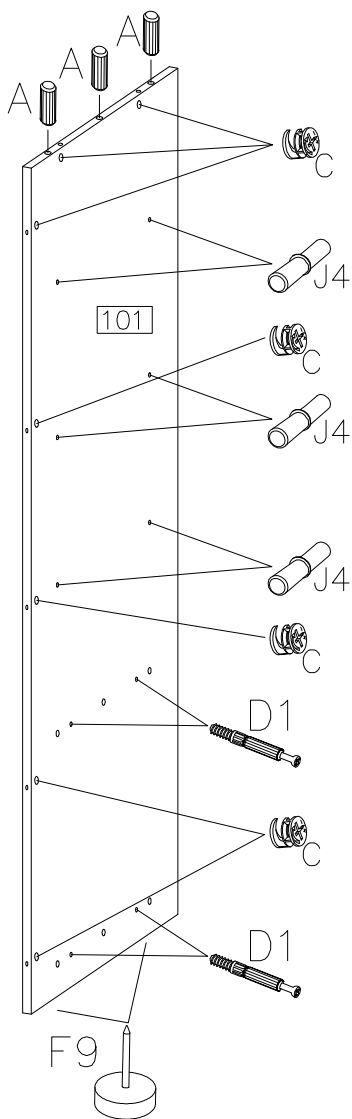
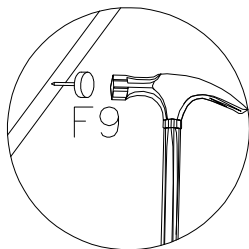
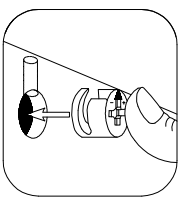
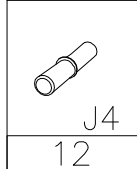
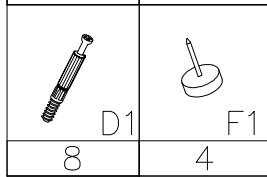
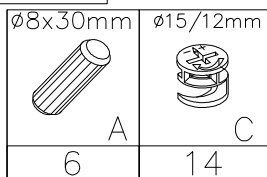

3

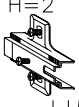

4

			
E	H5	D1	C
10	5	10	2

∅15/12mm

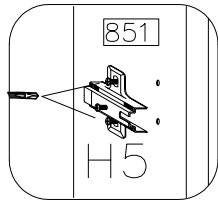
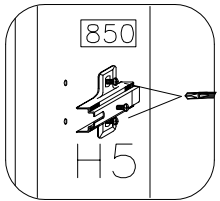
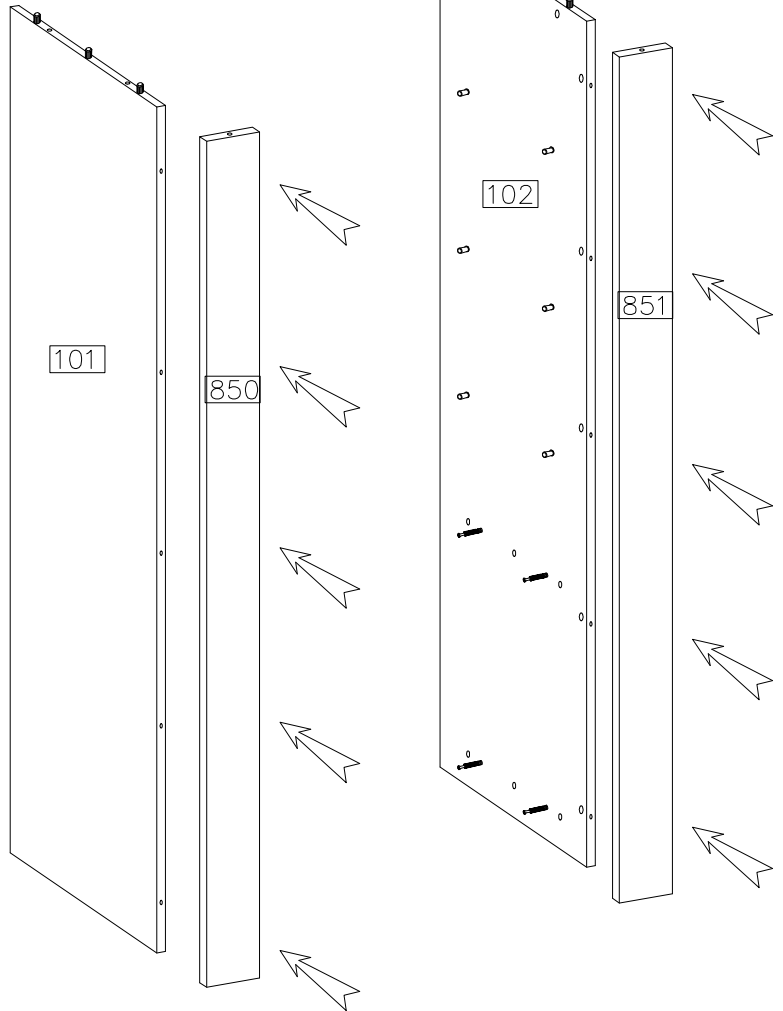
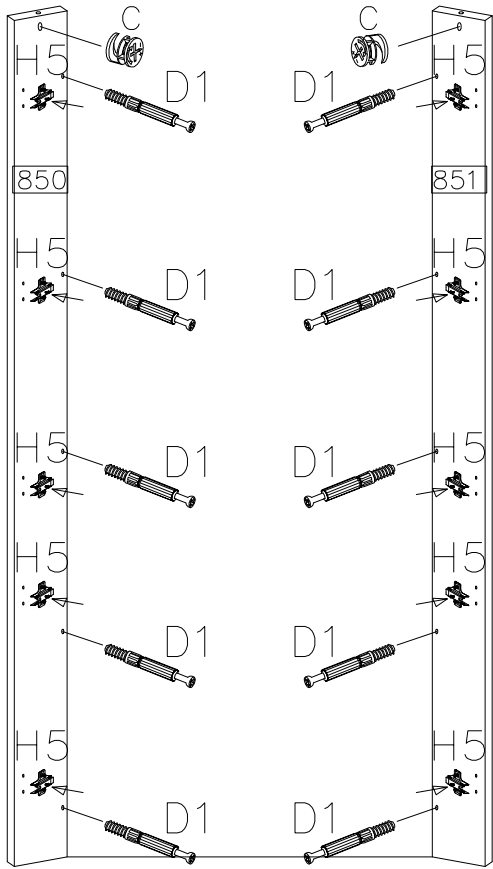

VERSION-L

VERSION-R

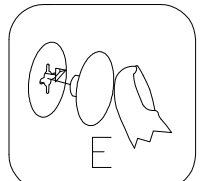
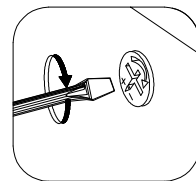
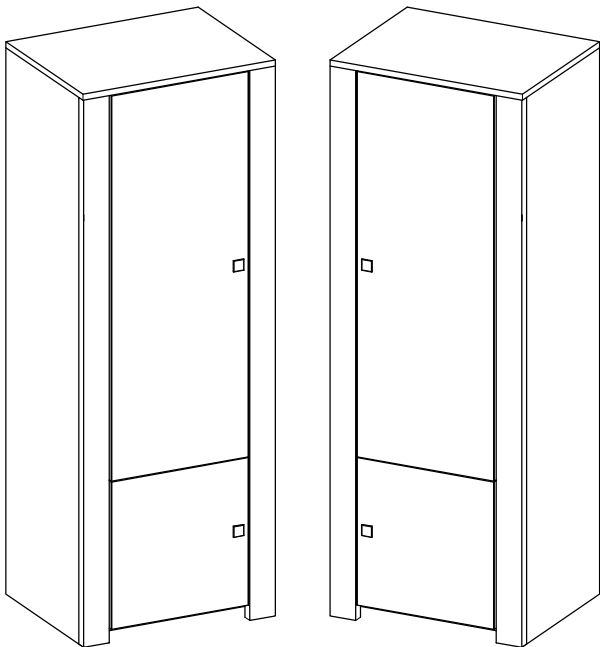

5

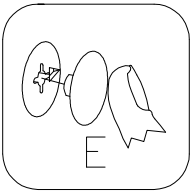
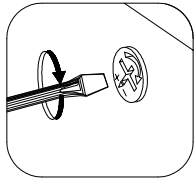
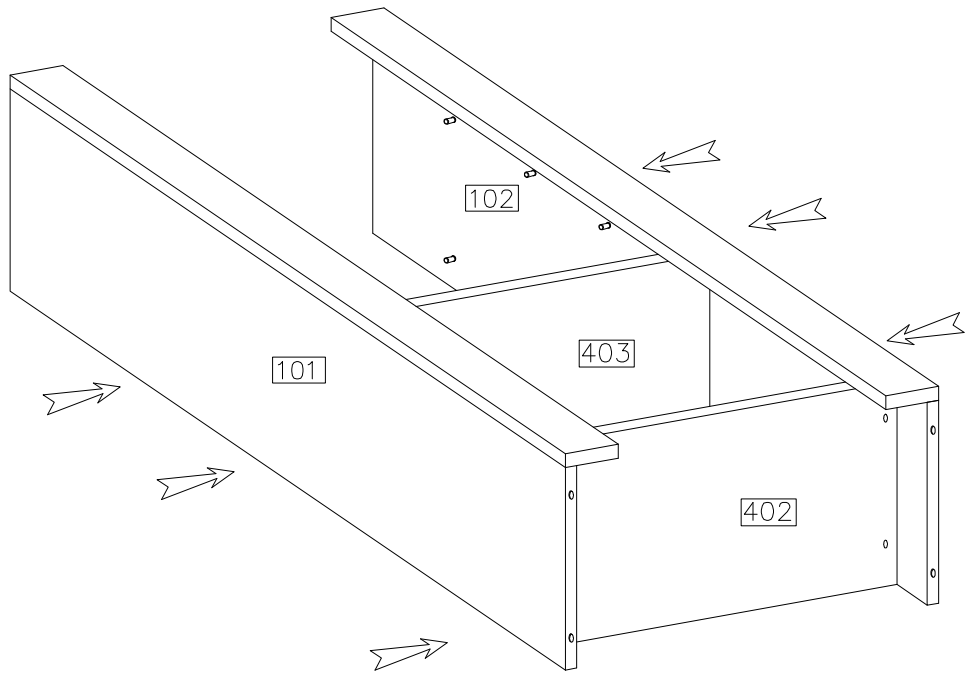
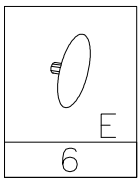

6

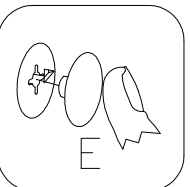
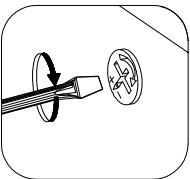
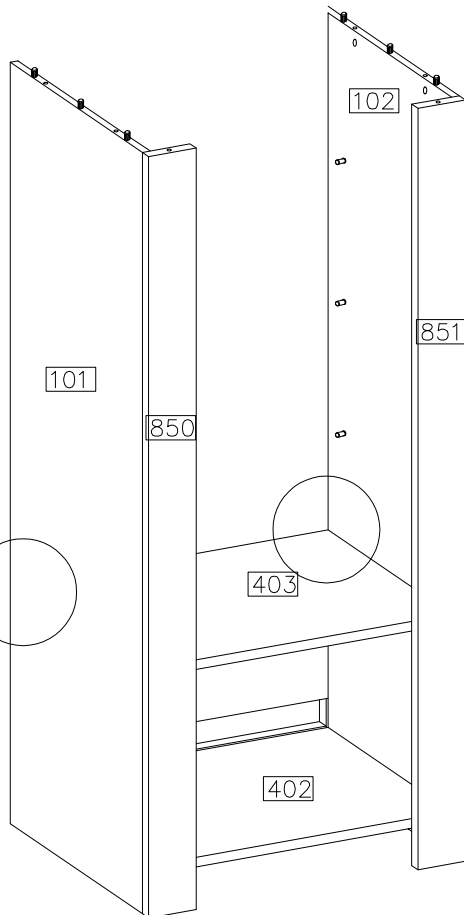
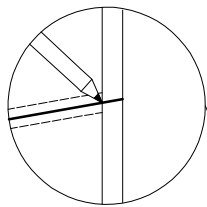
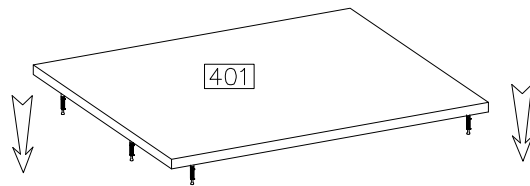
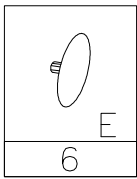

7

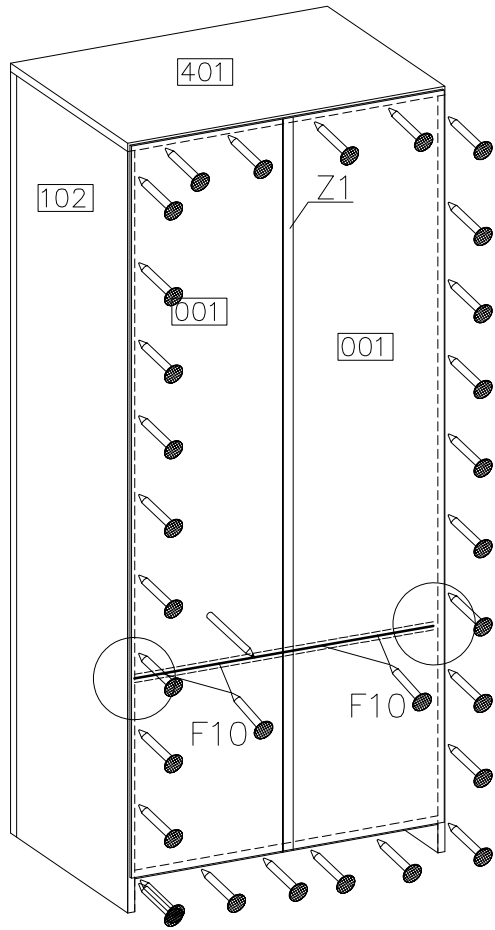
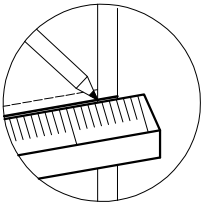
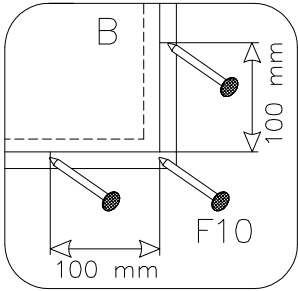
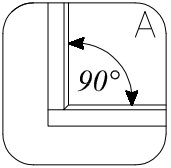
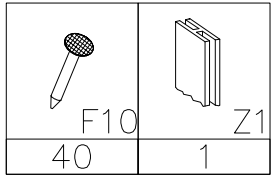

8

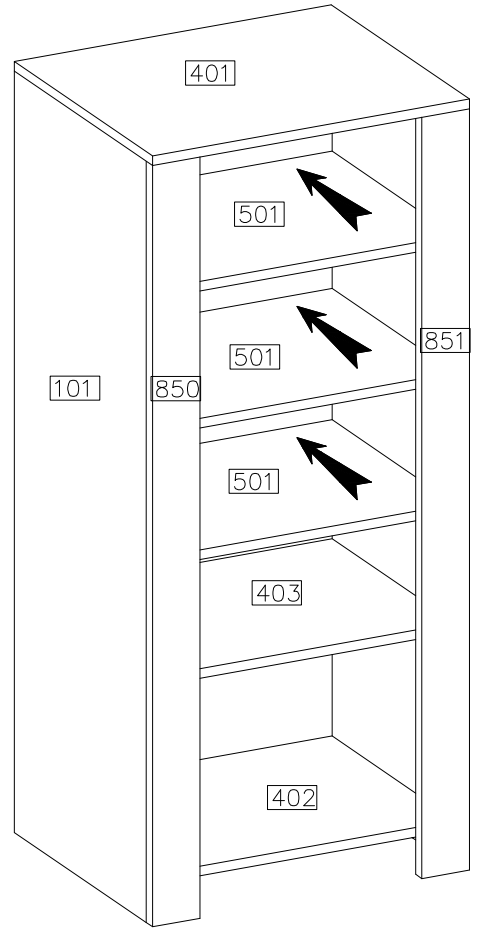

9

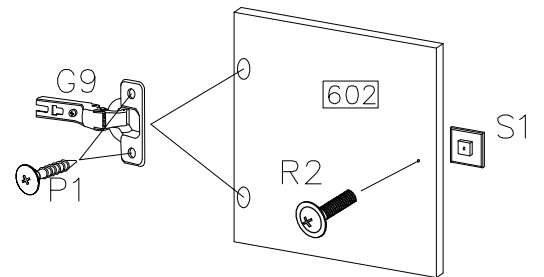
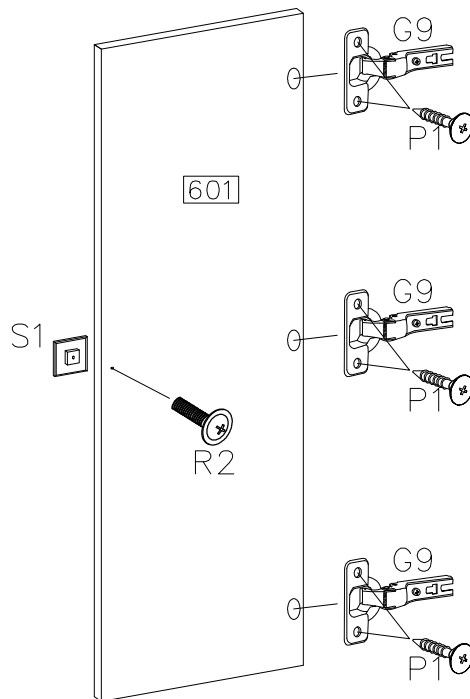
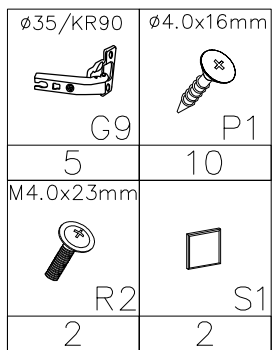

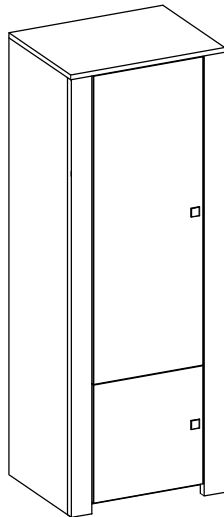

VERSION-L

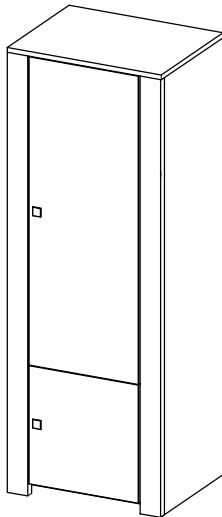

VERSION-R

