

INDIANAPOLIS 1

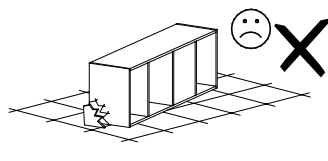

Narzędzia potrzebne do montażu

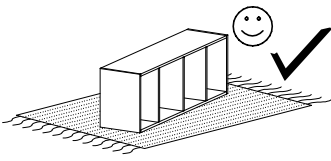
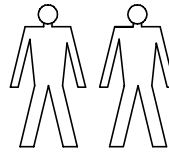
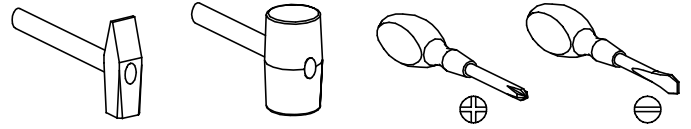

UWAGA !!!

MONTOWANIE USZKODZONYCH
ELEMENTÓW POWODUJE UTRATĘ
GWARANCJI

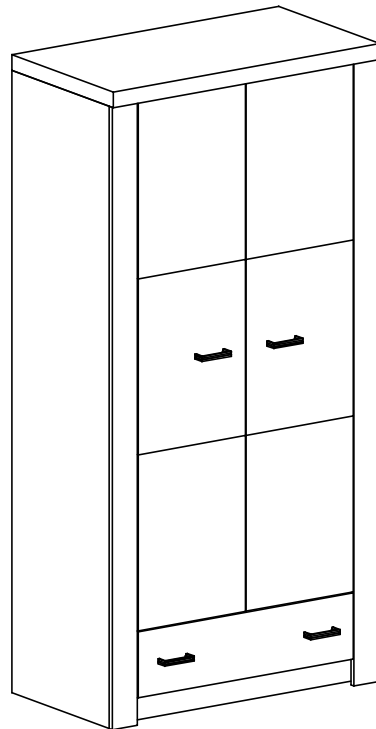

Nr	D[mm]	S[mm]	G[mm]	Ilość
1	927	563	16	2
2	563	176	16	1
3	563	176	16	1
4	1870	563	16	1
5	1870	80	16	1
6	1870	563	16	1
7	1870	80	16	1
8	927	80	16	1
9	960	580	48	1
10	1800	950	2,5	1
11	1583	393	16	2
12	793	190	16	1
13	500	150	16	1
14	500	150	16	1
15	740	150	16	1
16	770	505	2,5	1
17	927	80	16	1

W przypadku reklamacji proszę podać numer pakowacza znajdujący się na kartonie.

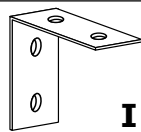

I - 1 St.

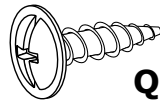

Q - 2 St.
3,5x16 mm



X1 - 16 St.



X2 - 12 St.

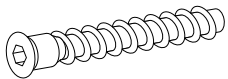

A - 12 St.

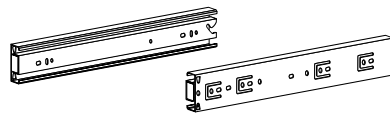

T - 1 Kpl.

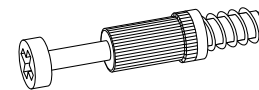

K - 16 St.

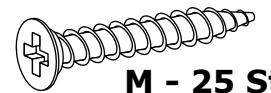

M - 25 St.
3x30 mm

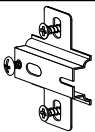

C - 6 St.

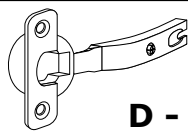

D - 6 St.



R - 1 St.
920 mm

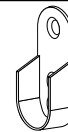

Y - 2 St.

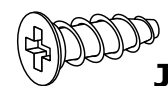

J - 8 St.
5x13 mm

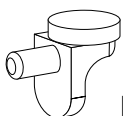

F - 2 St.

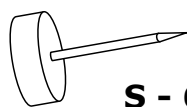

S - 6 St.



U - 4 St.

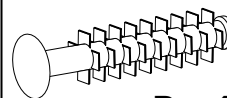

P - 4 St.

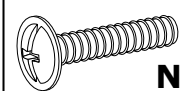

N - 8 St.
4x22 mm

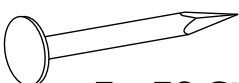

E - 50 St.

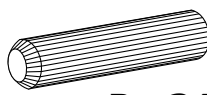

B - 34 St.

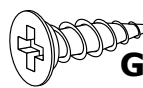

G - 22 St.
3,5x16 mm

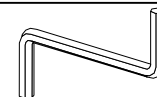

Z - 1 St.

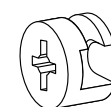

L - 16 St.

I

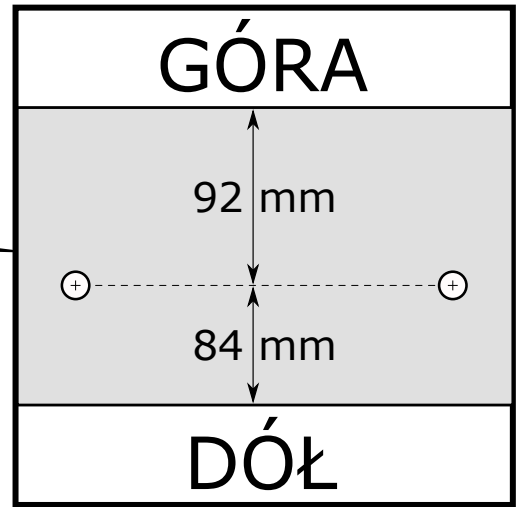
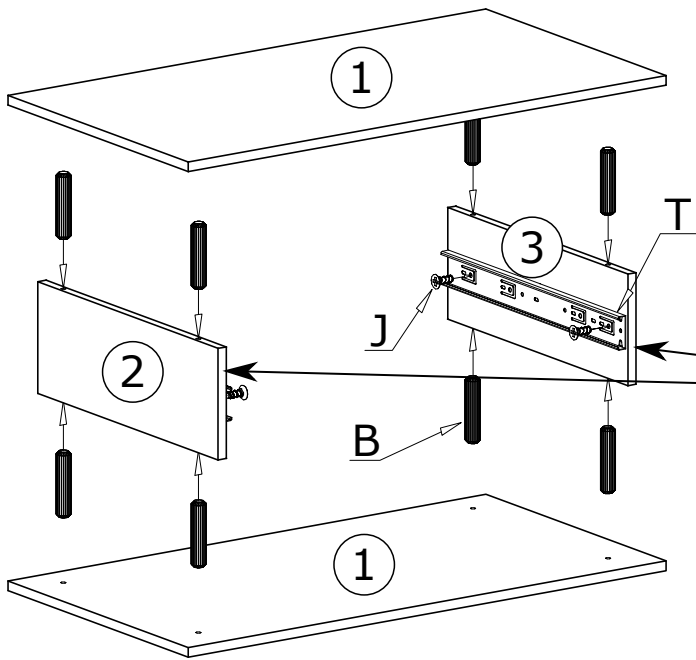

II

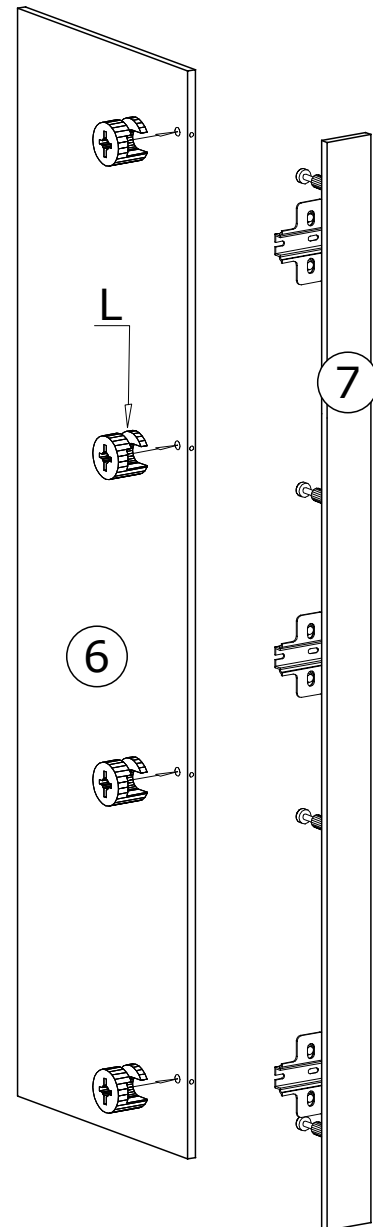
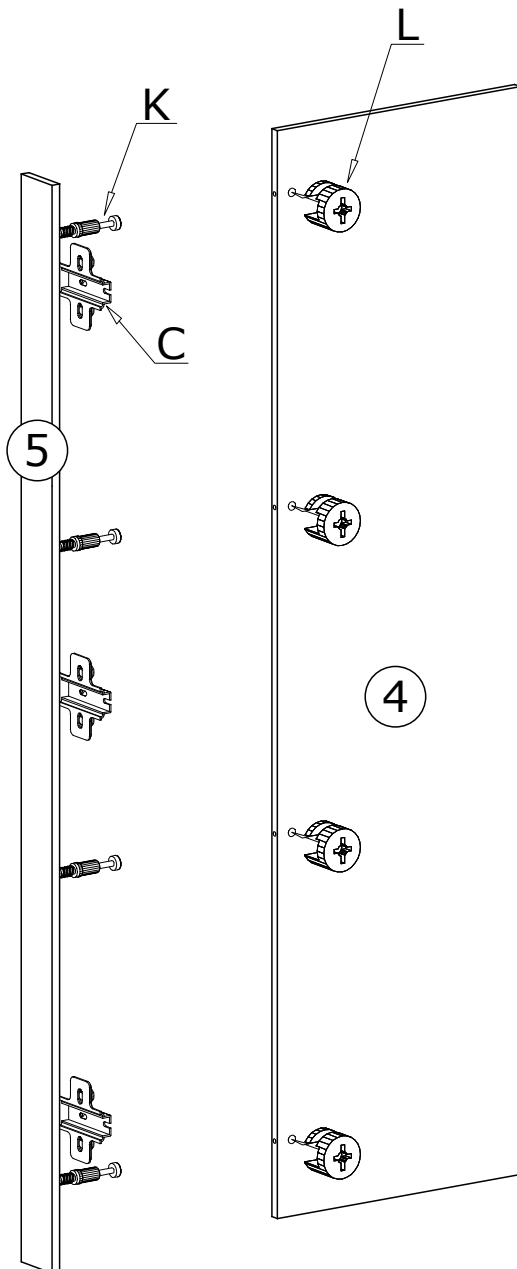

III

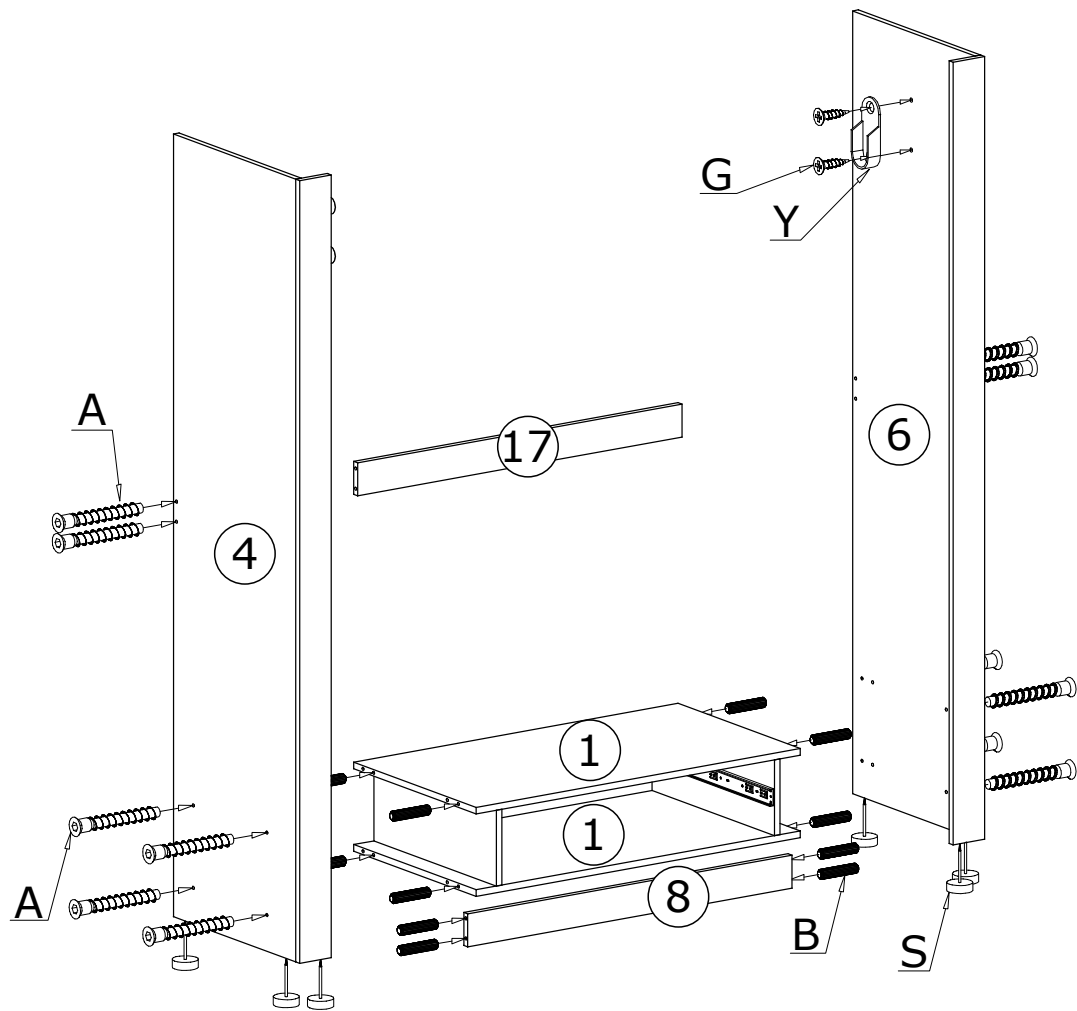

IV

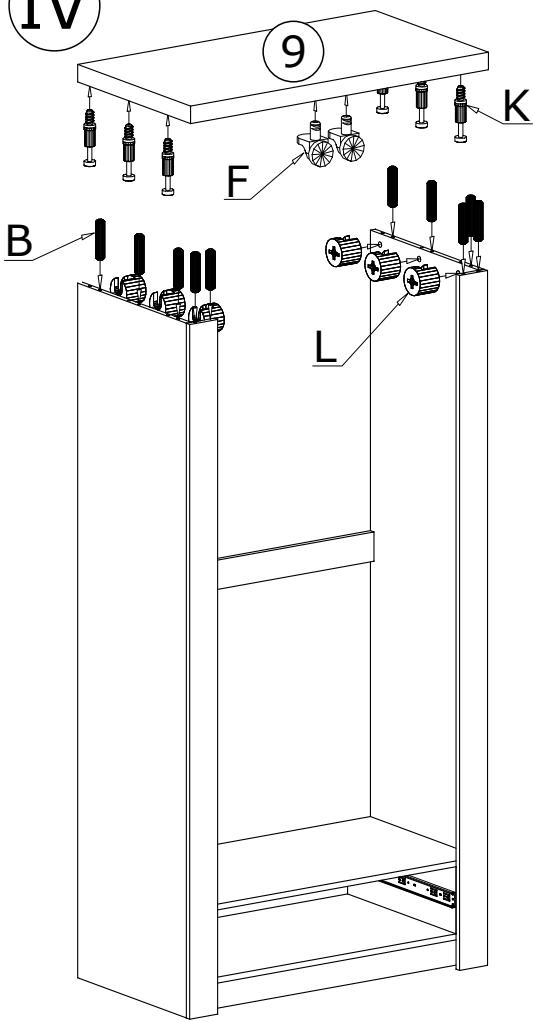

V

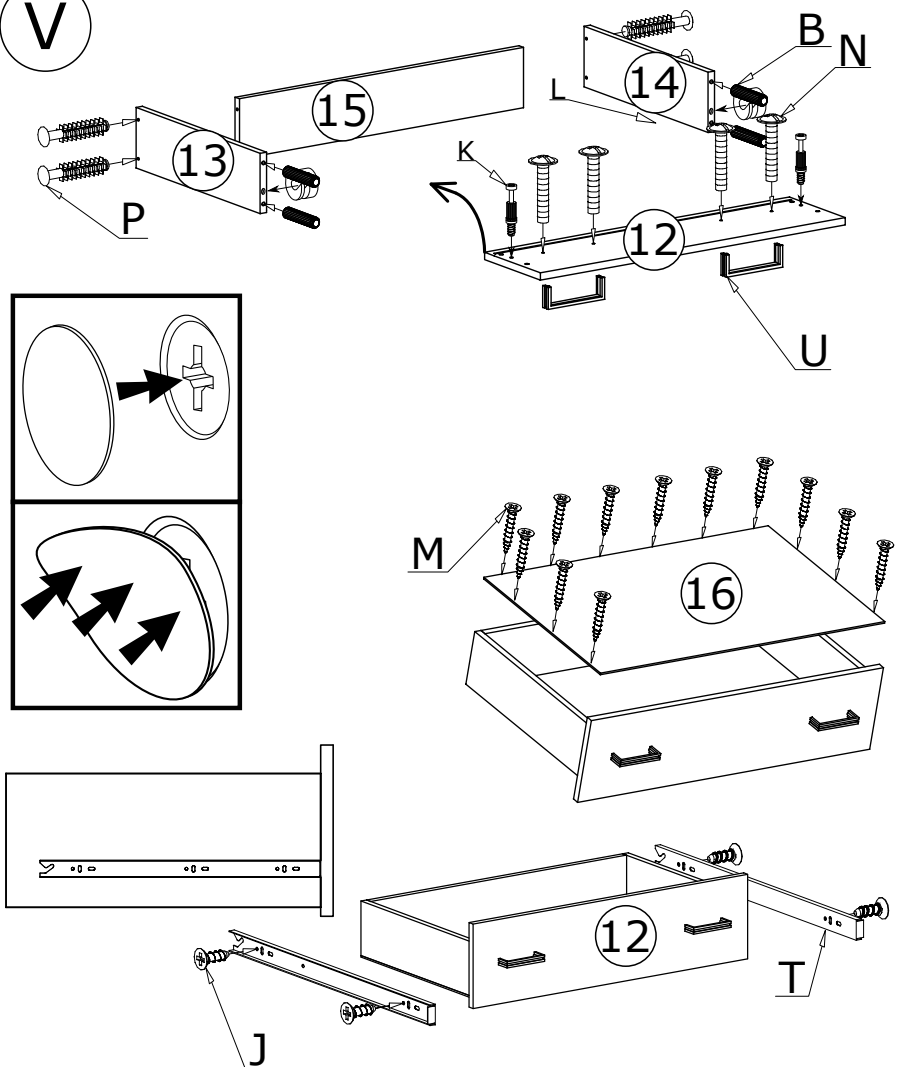

VI

50X 

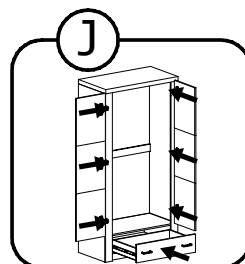
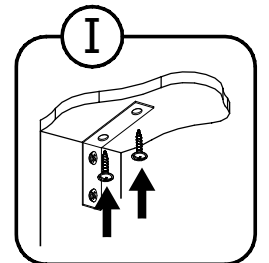
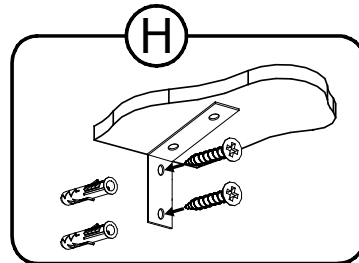
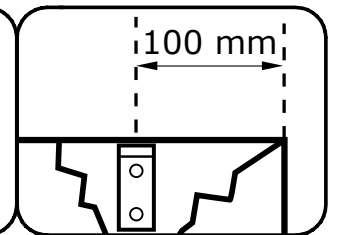
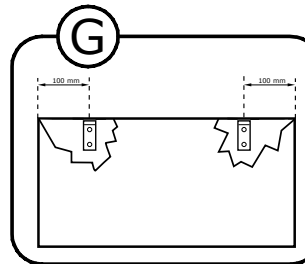
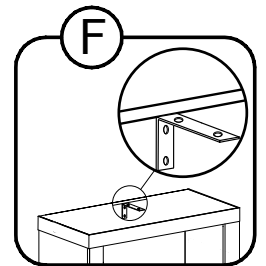
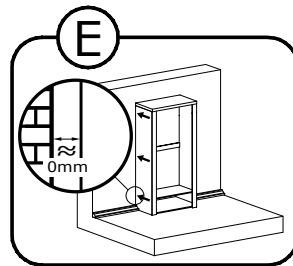
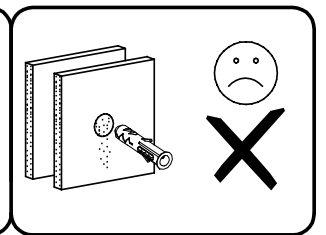
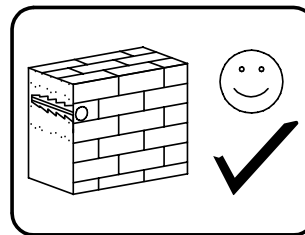
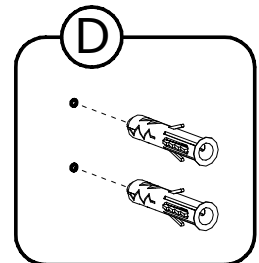
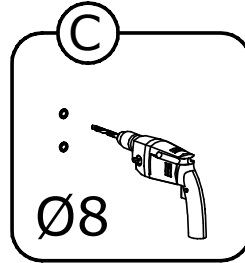
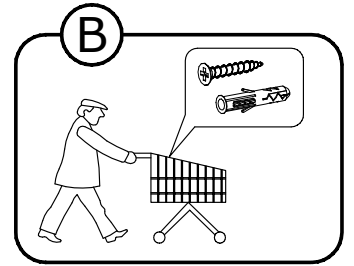
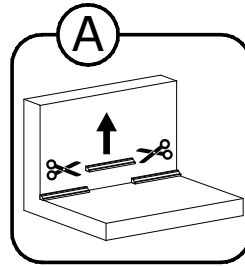
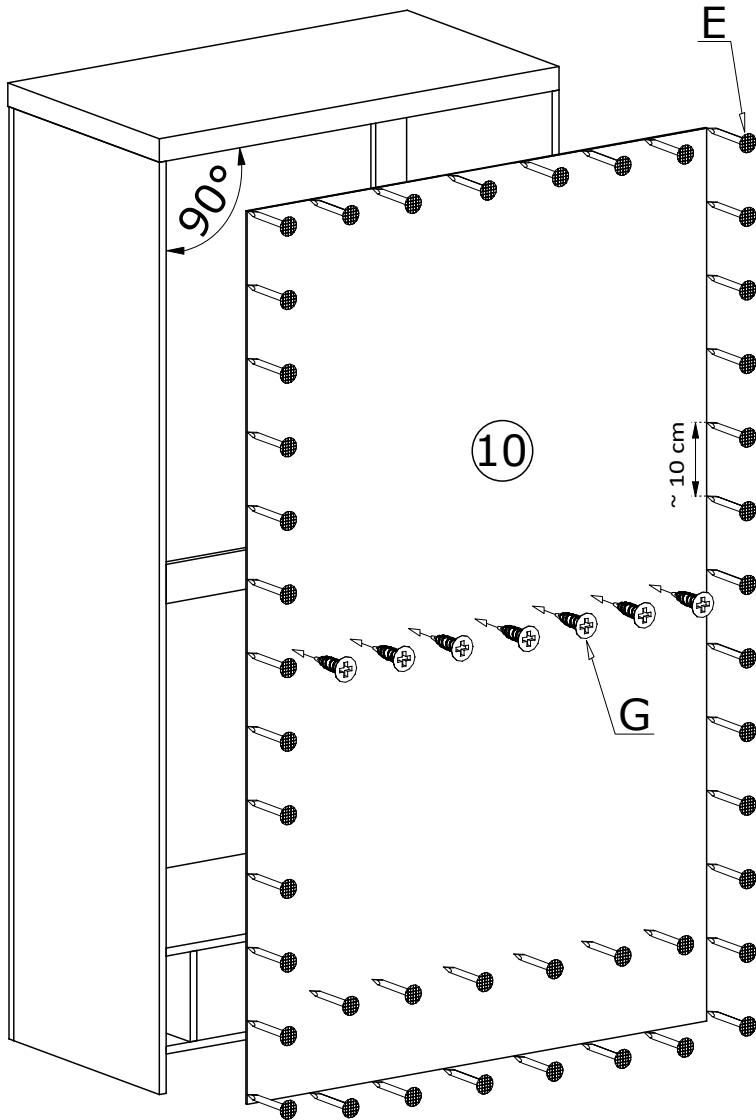

VII

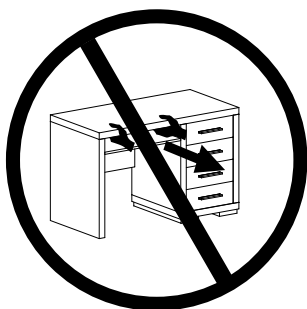
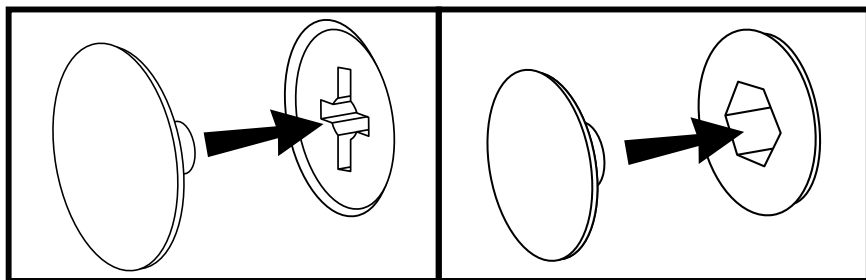
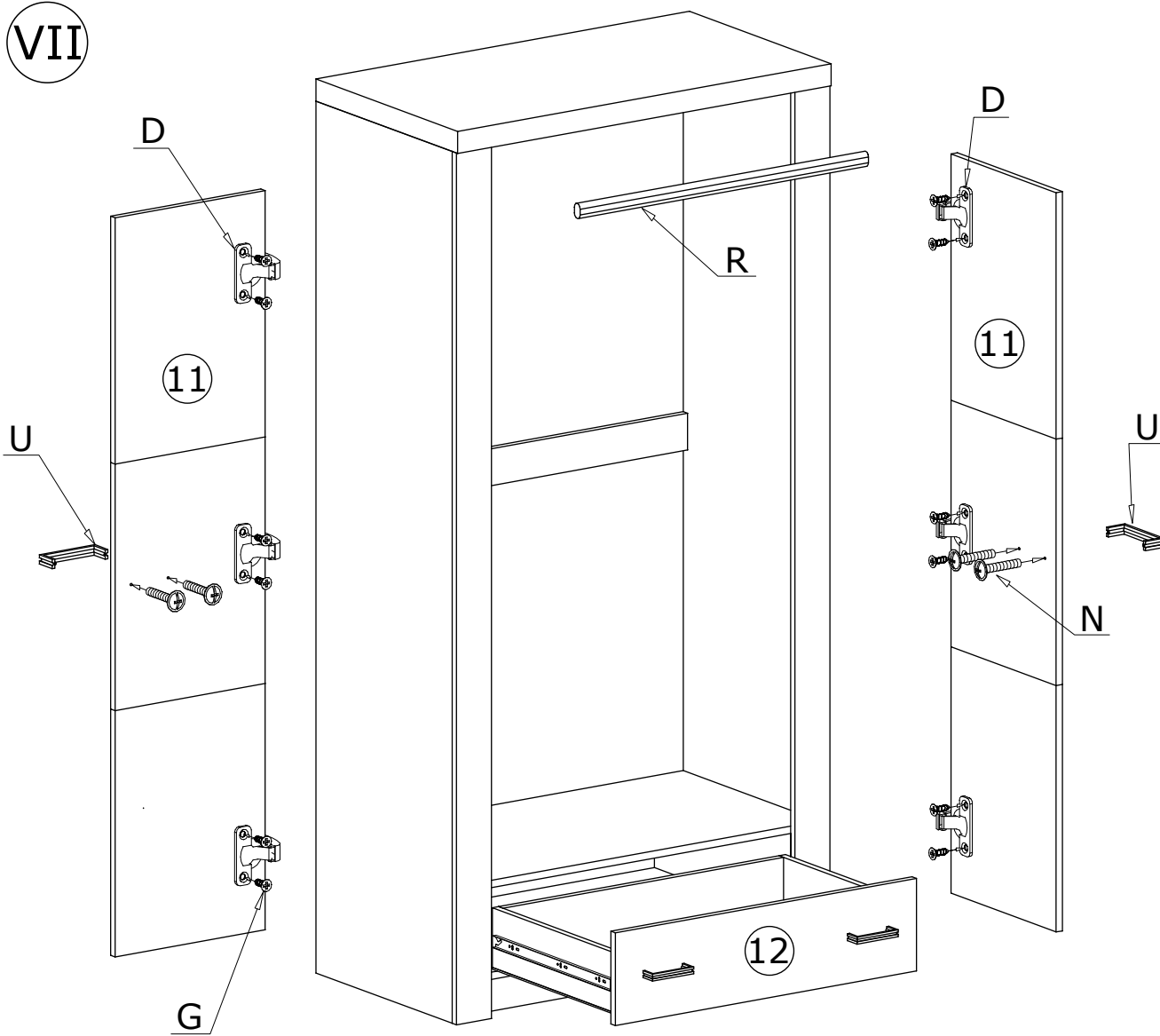

MONTAŻ/DEMONTAŻ PROWADNIC

1

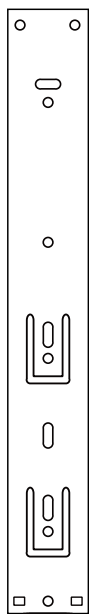

2

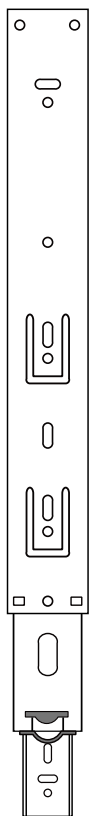

3

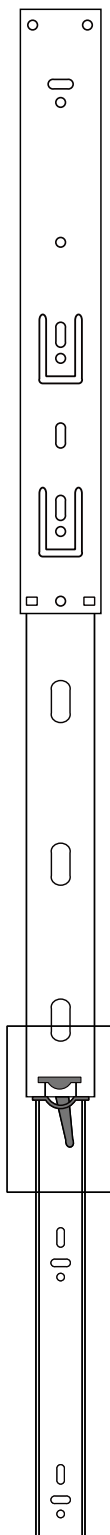

4

