

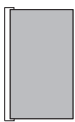









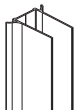



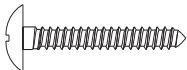



NO.	Designation	Pieces	NO.	Designation	Pieces
1		X2	10 ₁		X2
2		X2	10 ₂		X2
3	 $\varnothing 8$	X6+1	11 ₁		X2
4	 $\varnothing 4$ ST4X35	X6+1	11 ₂		X2
5	 $\varnothing 4$ ST4X10	X4+1	12 ₁		X1
6	 $\varnothing 4$ ST4X30	X4+1	12 ₂		X1
7		X4+1	13		X1
8		X2	14		X2
9		X2	A ₁		X2
		A ₂	X4		
		A ₃	X8		
		A ₄	X4		
		B ₁		X4	
		B ₂		X4	
		B ₃		X2	
		B ₄		X2	
		C ₁		X4	
		C ₂		X4	
		C ₃		X2	
		C ₄		X8	
		C ₅		X4	
		C ₆		X2	
		D	No handle		
			 $\varnothing 8$  $\varnothing 3.2$		

1.

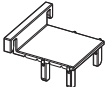
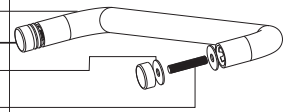
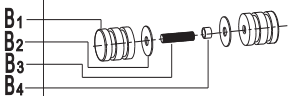
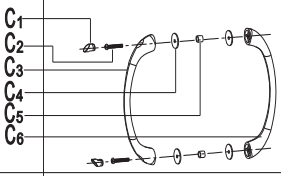

2.

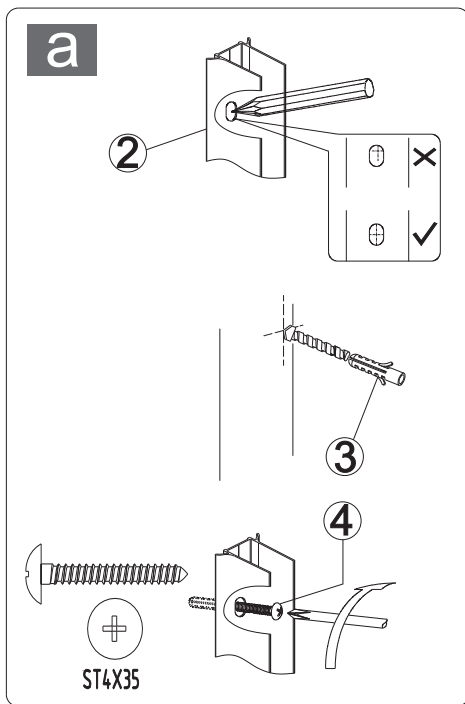
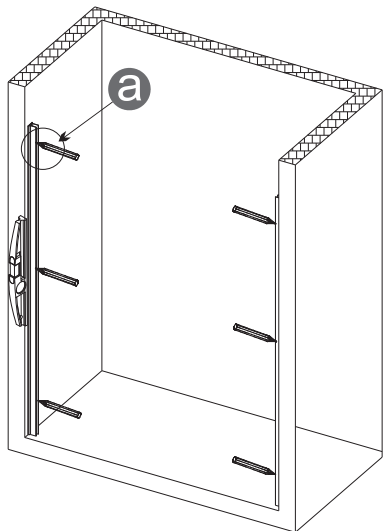
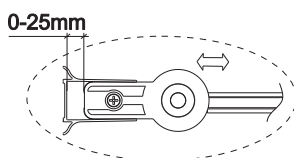
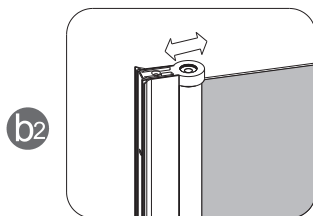
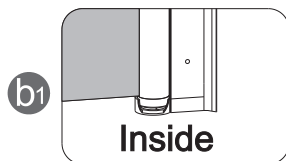
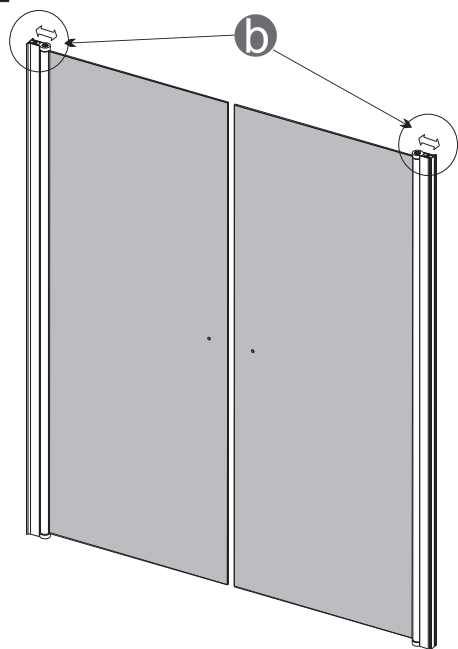

3.

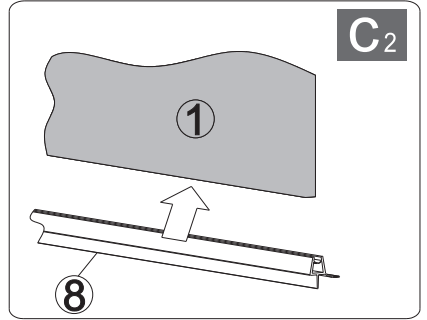
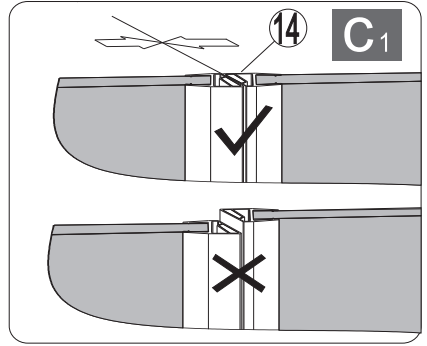
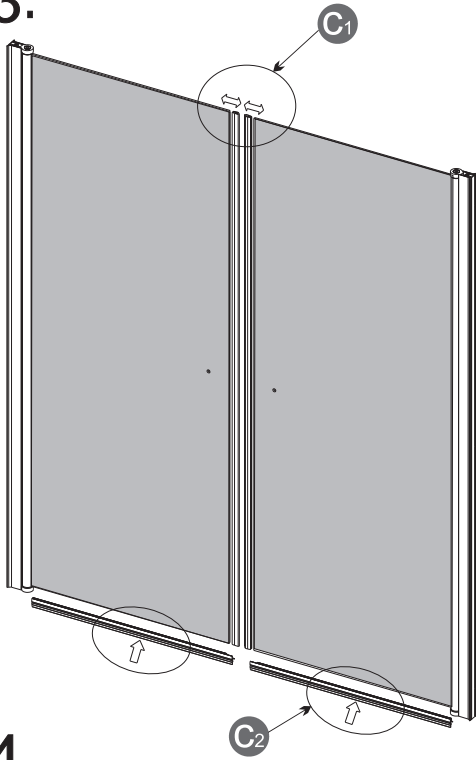

4.

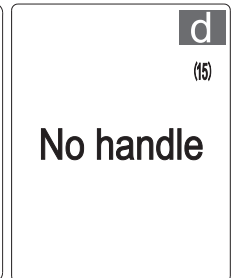
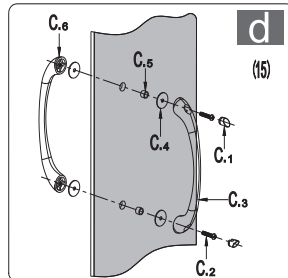
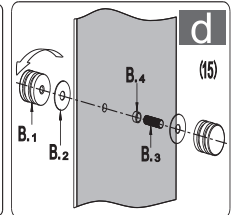
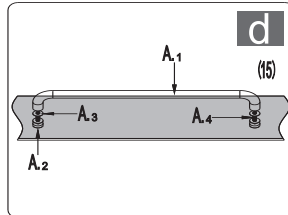
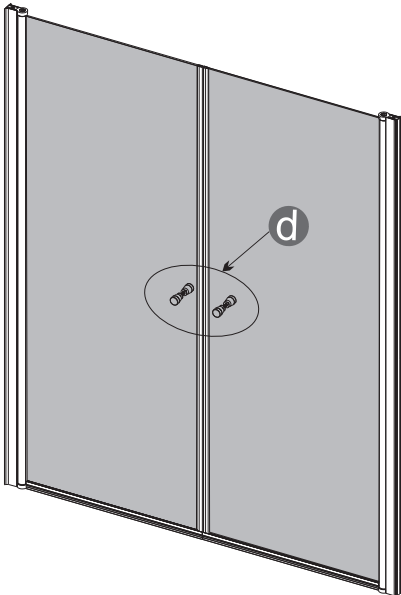

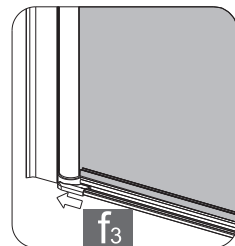
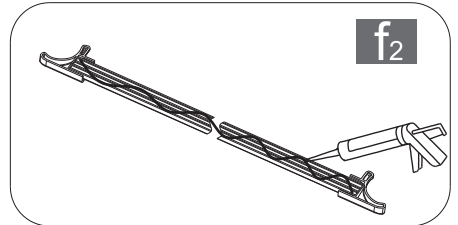
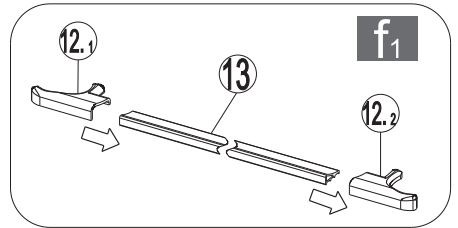
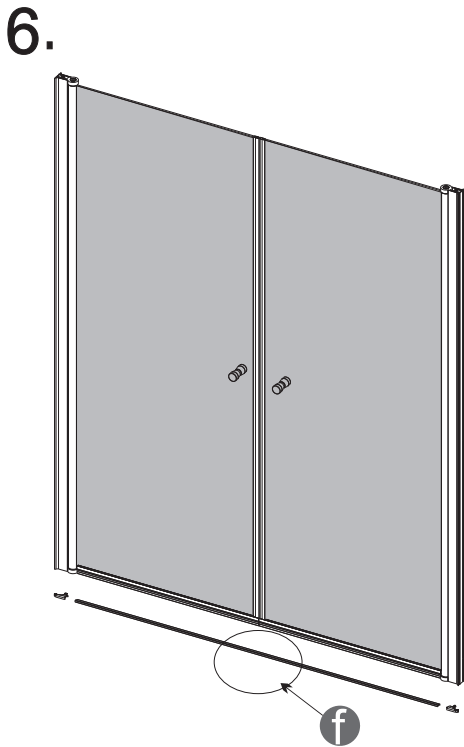
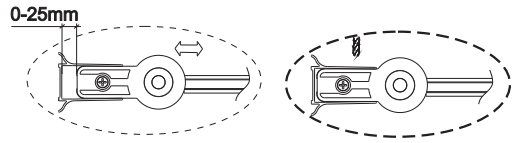
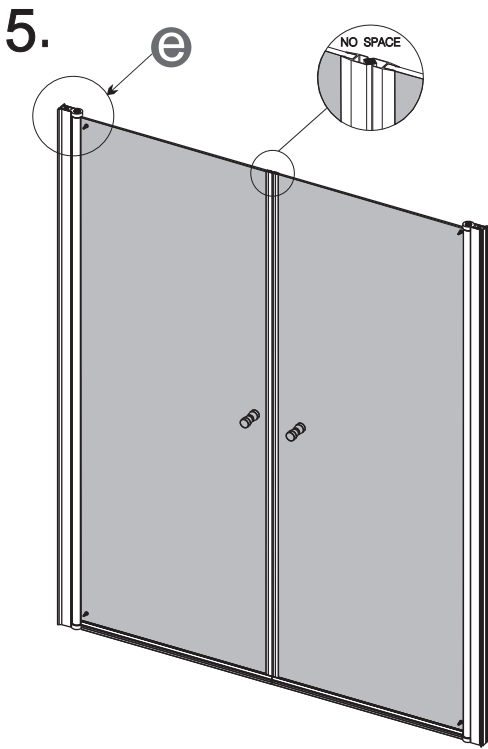

7.

