

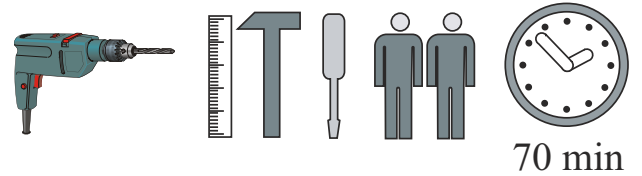

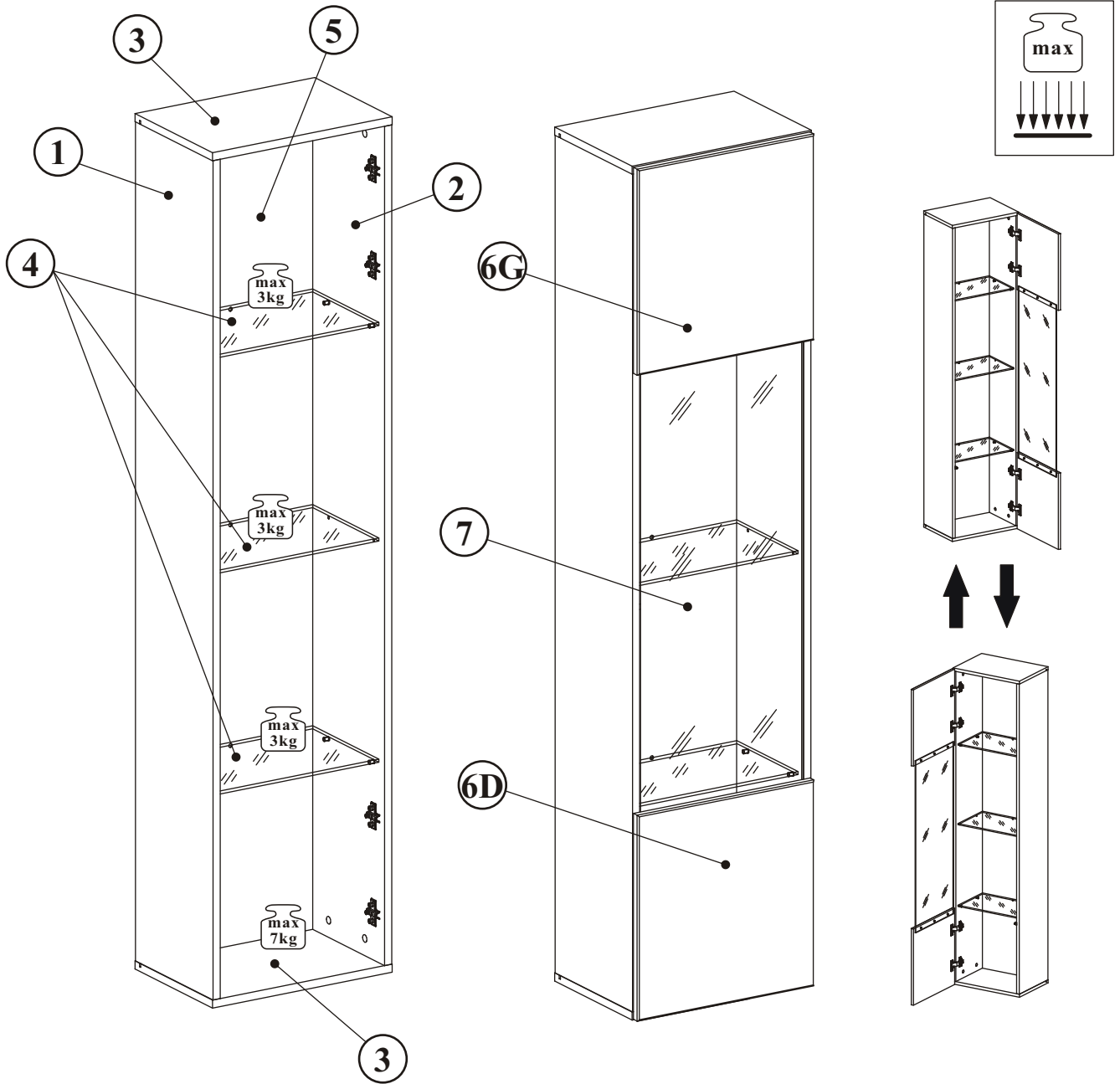







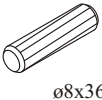
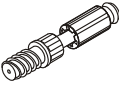

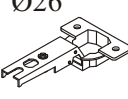
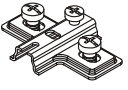
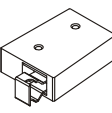
FLY TYP-42

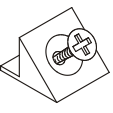

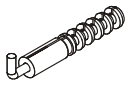
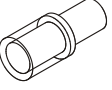
70 min

NO	Dim.			Col.-No	Qty
1	1668	274	16	1	1
2	1668	274	16	1	1
3	400	274	16	1	2
4	364	234	6	1	3
5	1680	378	3	1	1
6G	394	410	16	1	1
6D	394	410	16	1	1
7	925	362	4	1	1

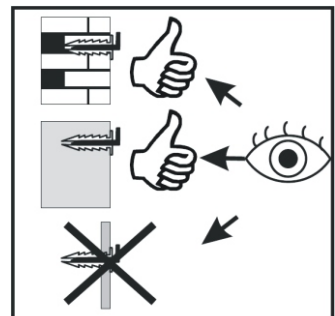
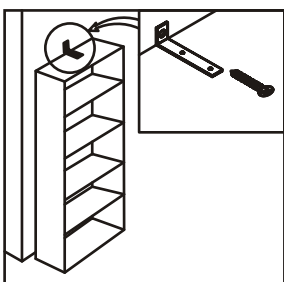
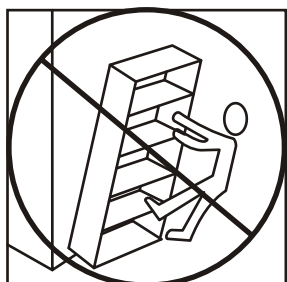
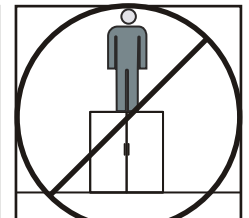
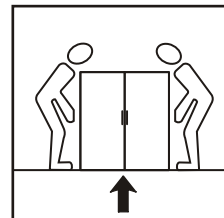
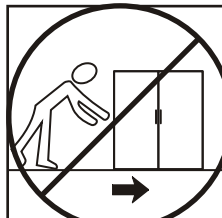
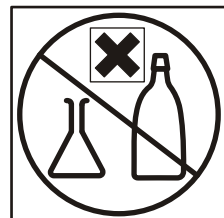
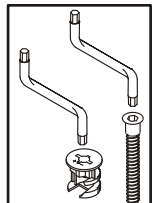
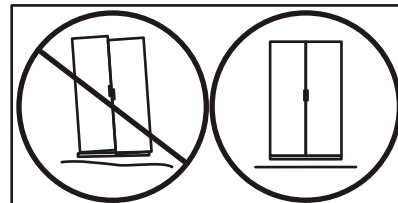
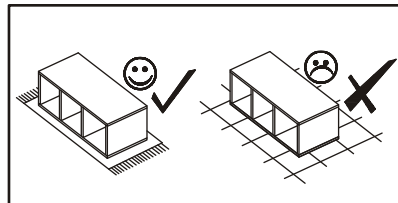
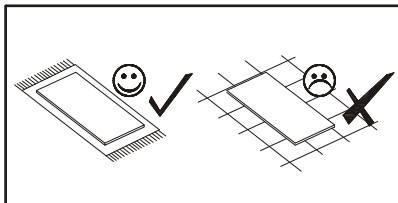
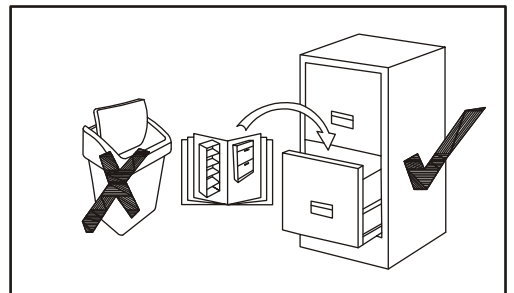
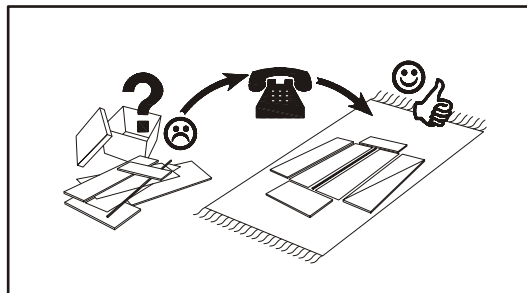
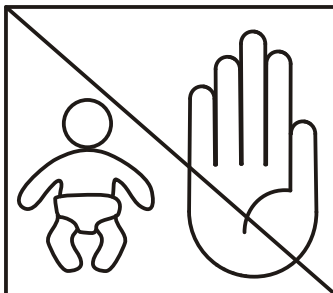
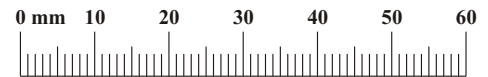

FLY TYP-42

A1 x8  ø8x36	B4 x8 	B5 x8  ø15x12	G5 x8 	E1 x4  Ø26 H=0	E2 x4  H=0
ZR1 x2 	D6 x4  USØ3,5x30	S1 x12 	D10 x10  USØ3,5x13	KR2 x2 	G20 x12 
Z2 x8  Ø5	T1 x1 	G2 x1 	UP13 x6  UPØ3x16	P2 x6 	

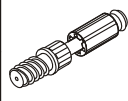
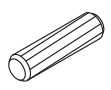

FLY TYP-42

1

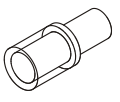
B4		A1		B5	
x8		x8	ø8x36	x8	ø15x12
		G20			
		x12			

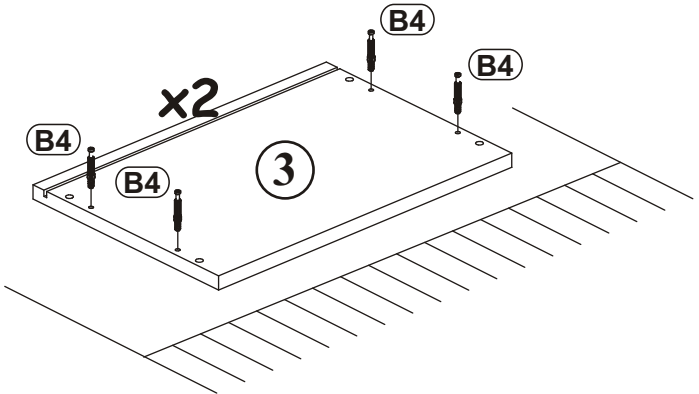
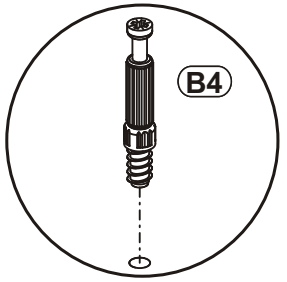
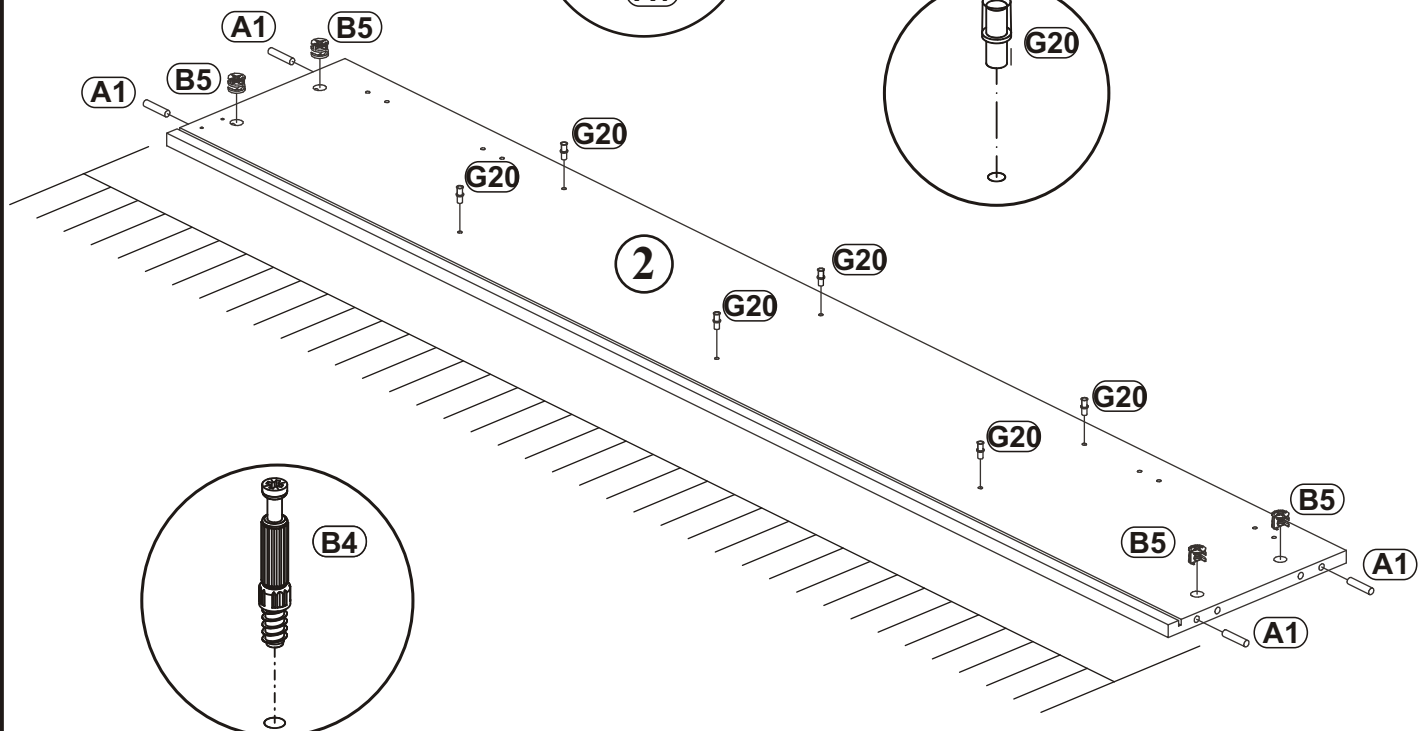
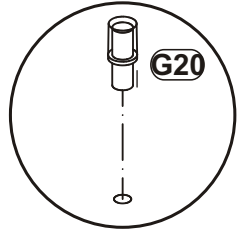
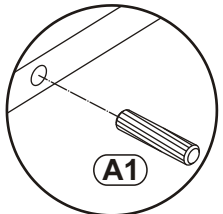
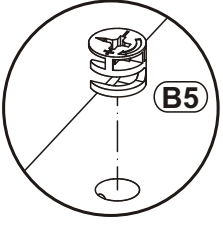
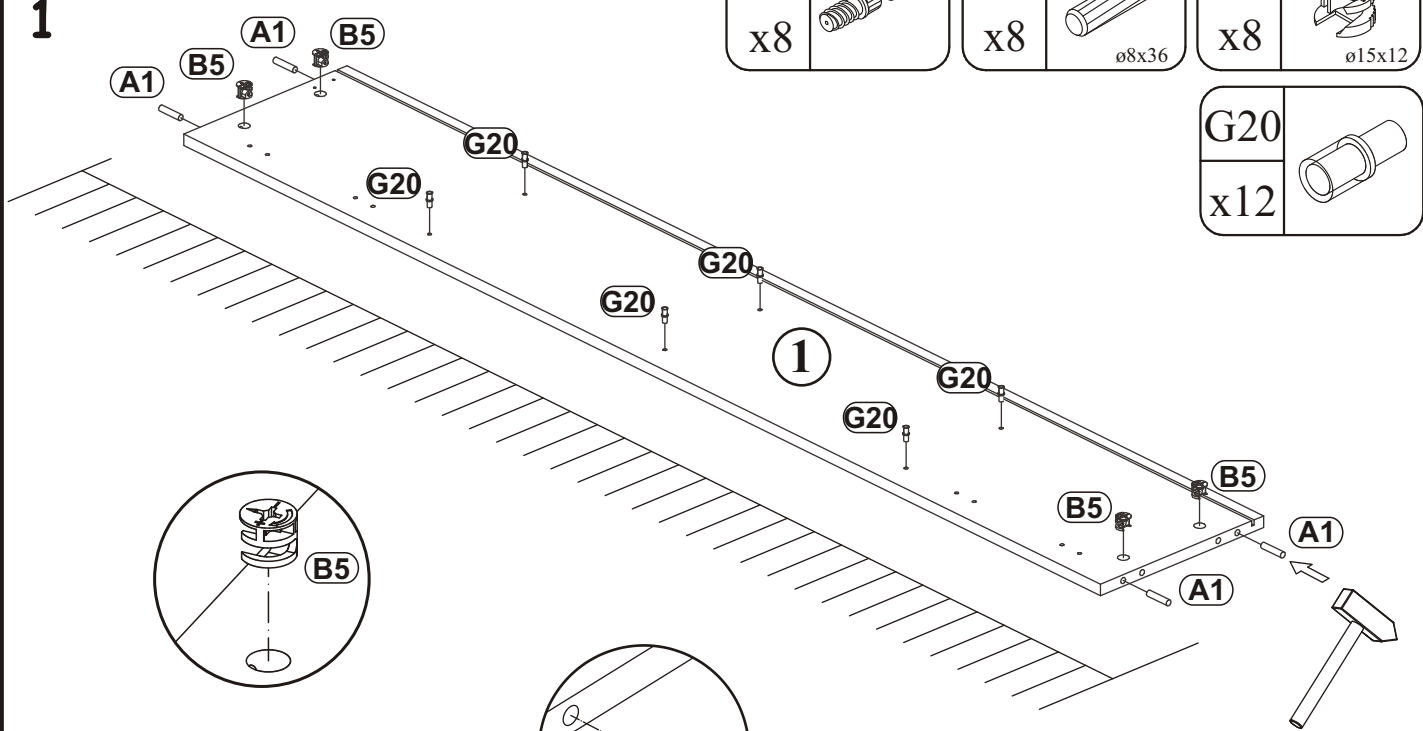

FLY TYP-42

2

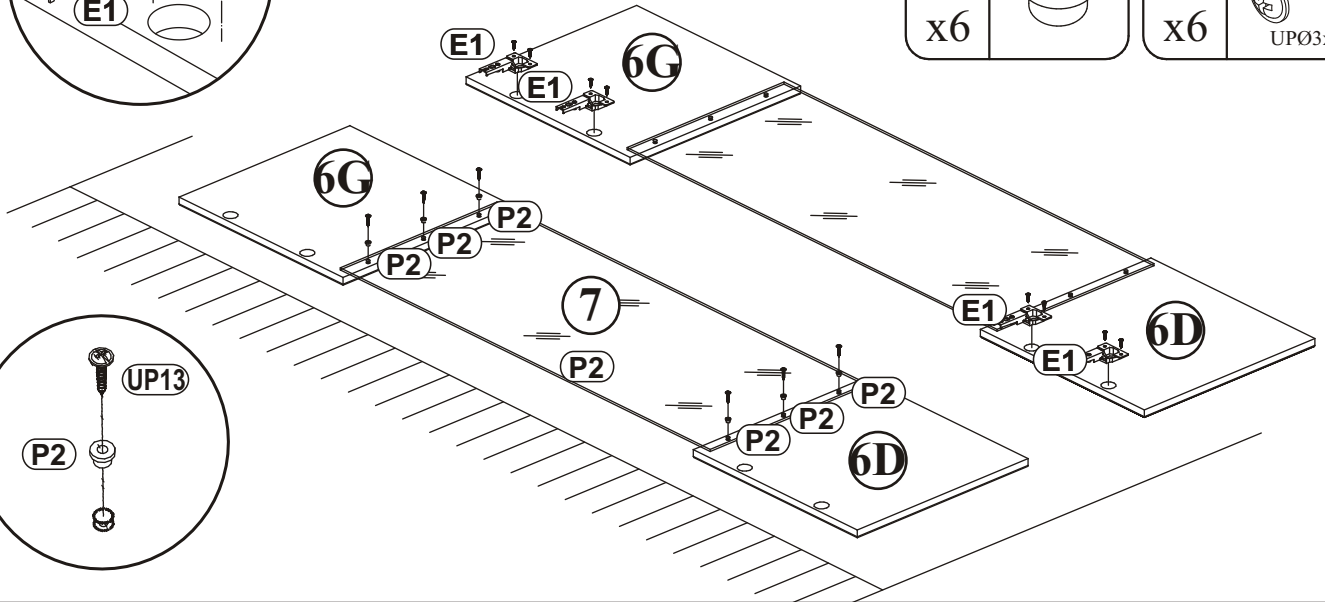
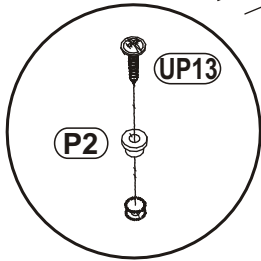
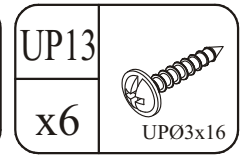
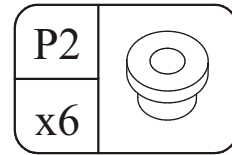
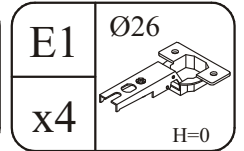
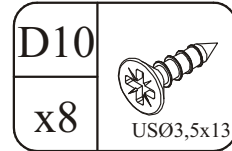
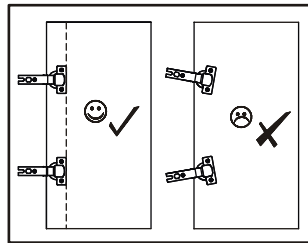
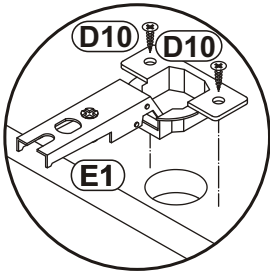

3

a)

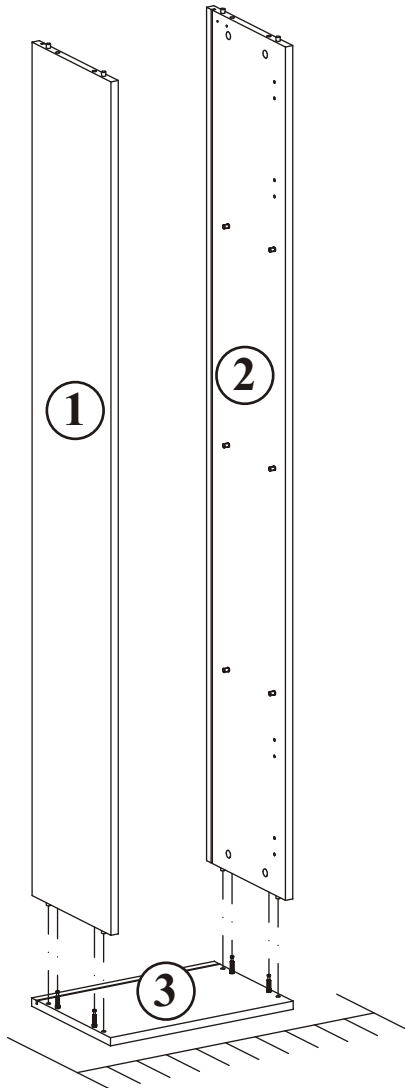

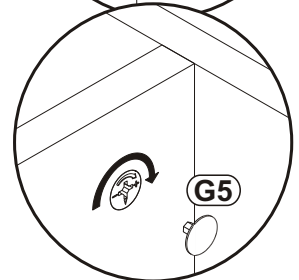
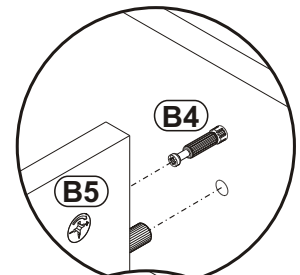
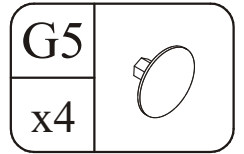
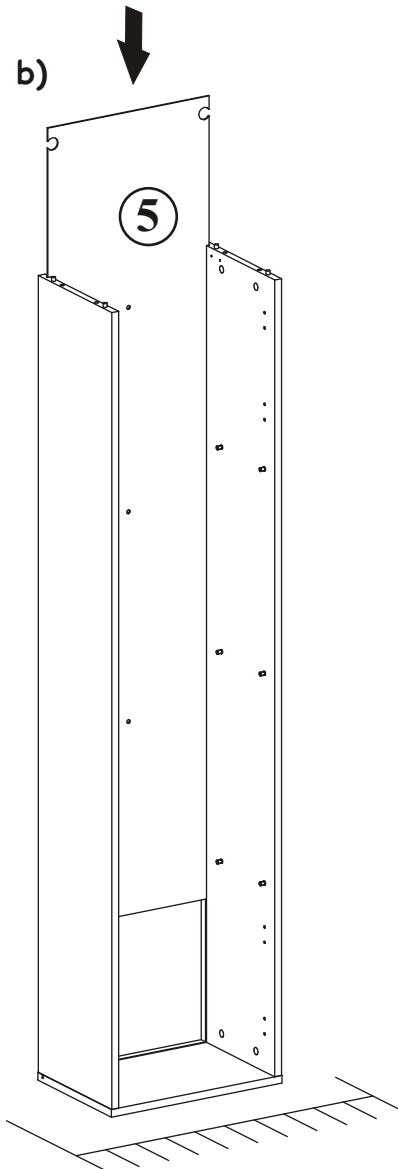

b)

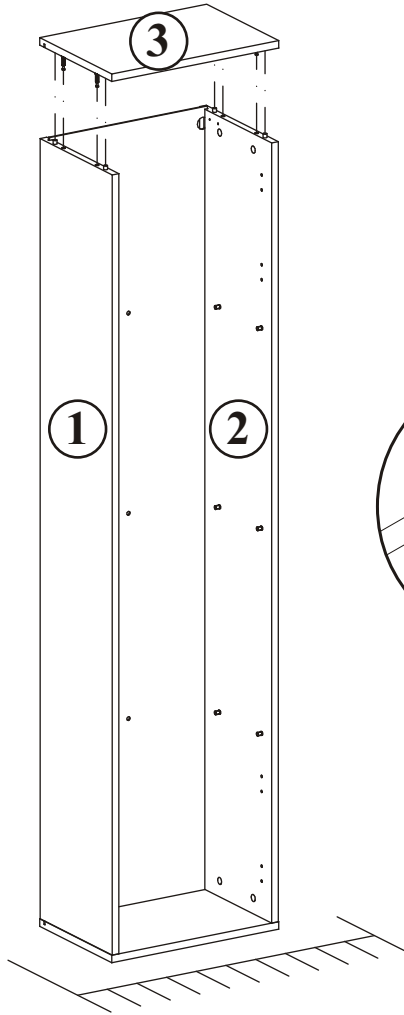

FLY TYP-42

4



G5	
x4	

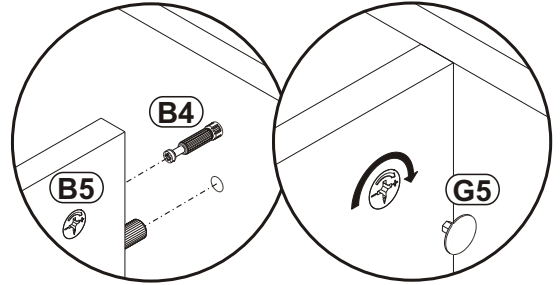

5

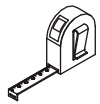

$X=Y$ 90°

Y

X

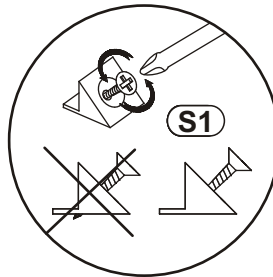
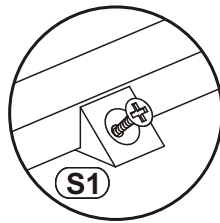

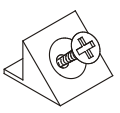
S1	
x12	

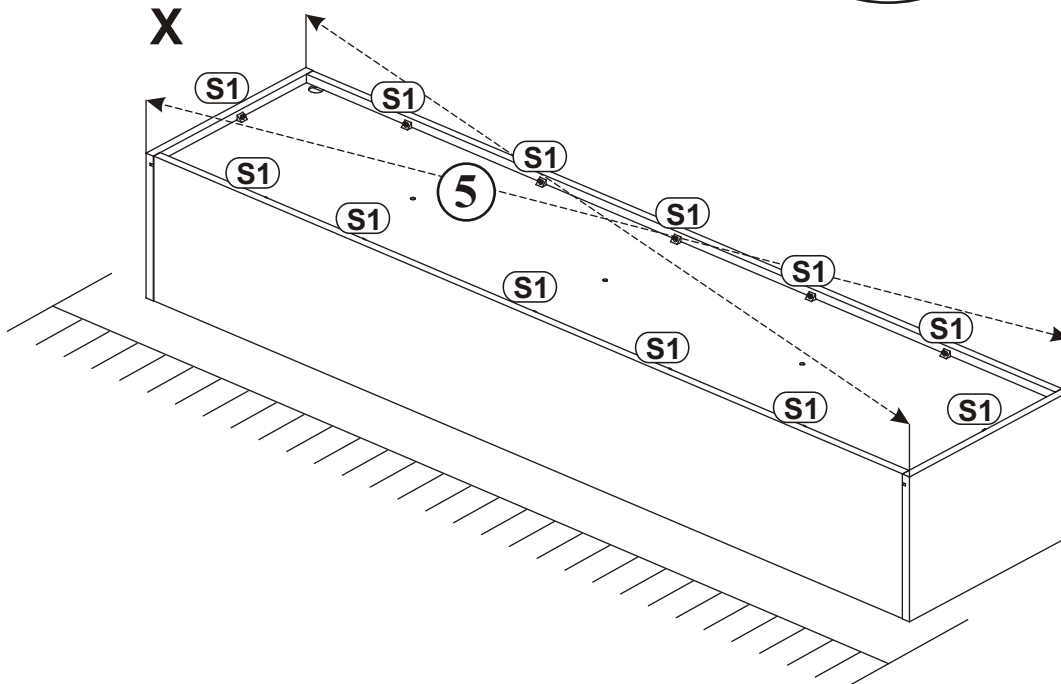

6

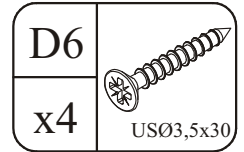
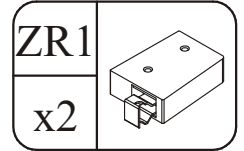
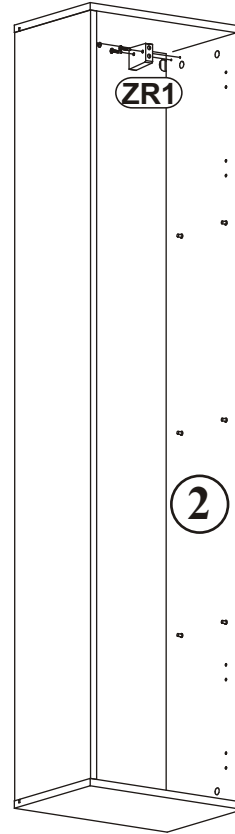
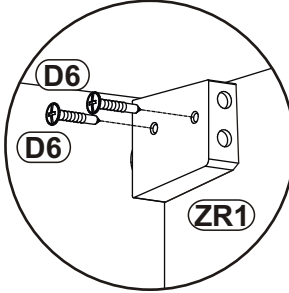
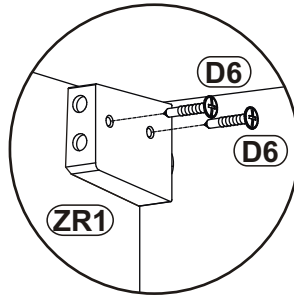
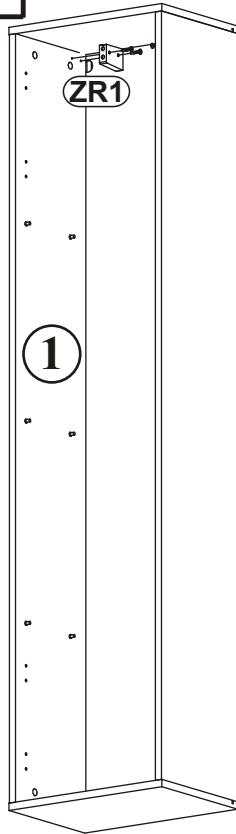

7

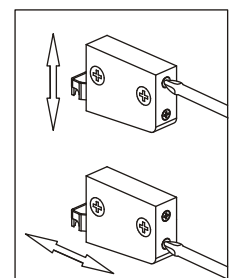
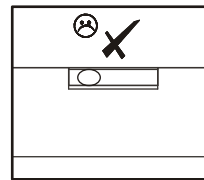
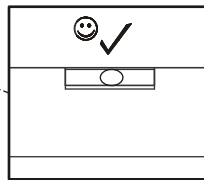
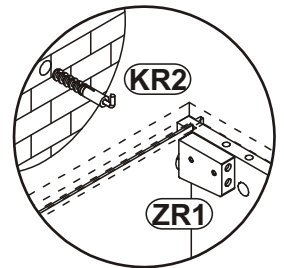
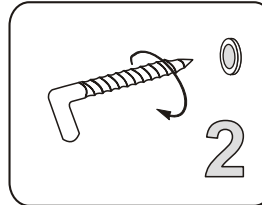
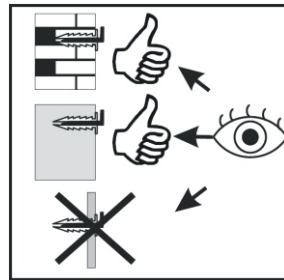
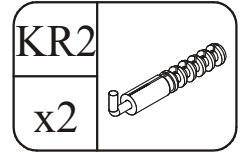
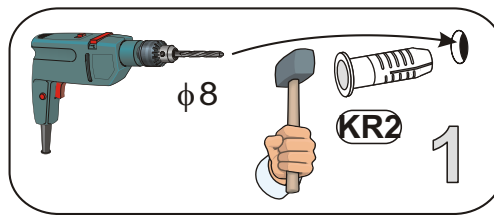
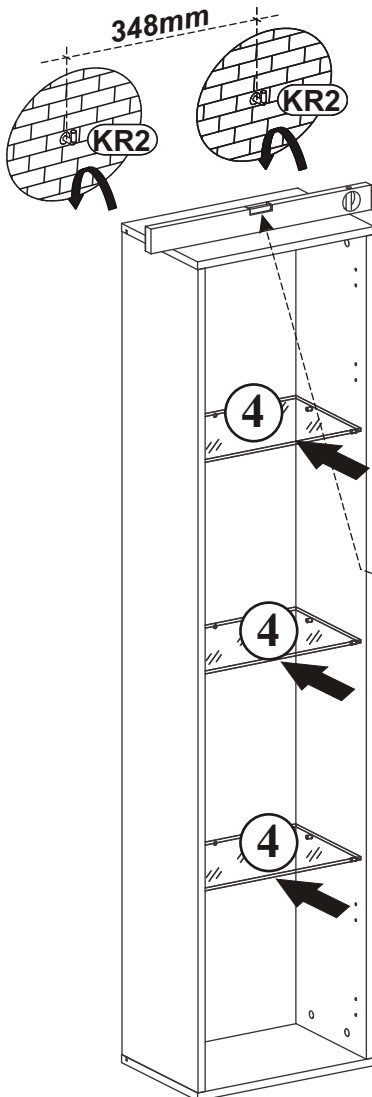

8 - 9

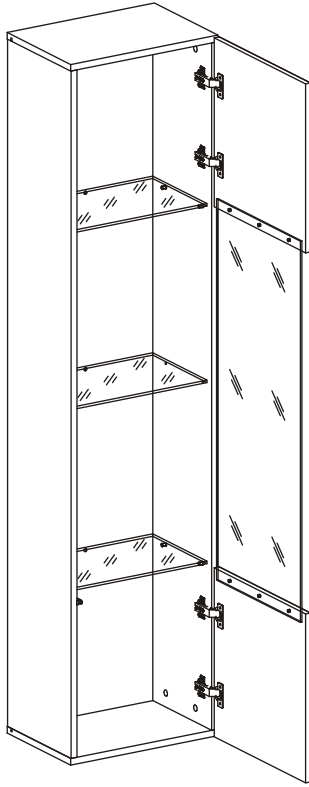

10 - 11

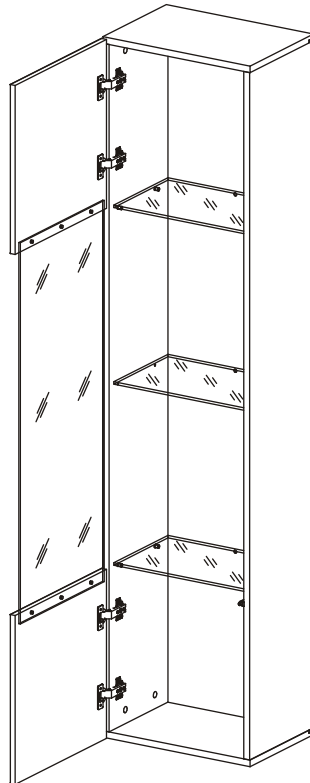

FLY TYP-42

8

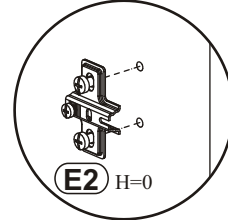
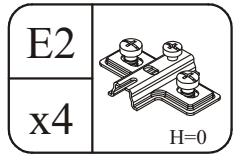
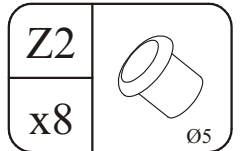
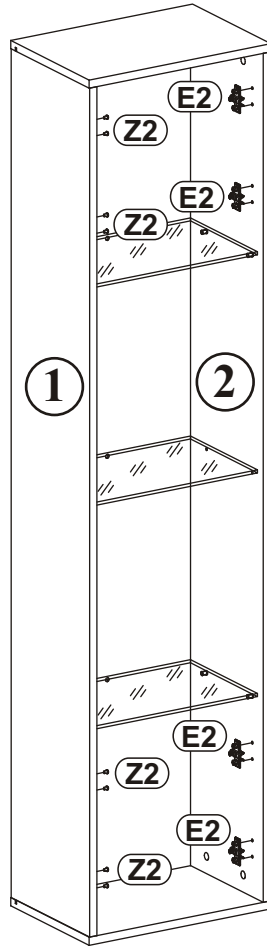
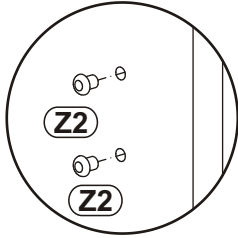
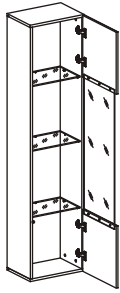

9

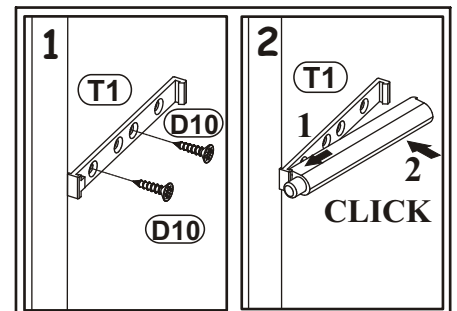
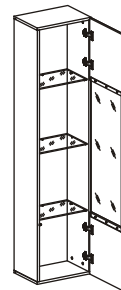
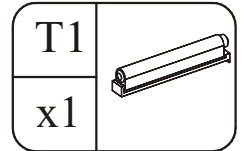
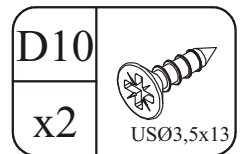
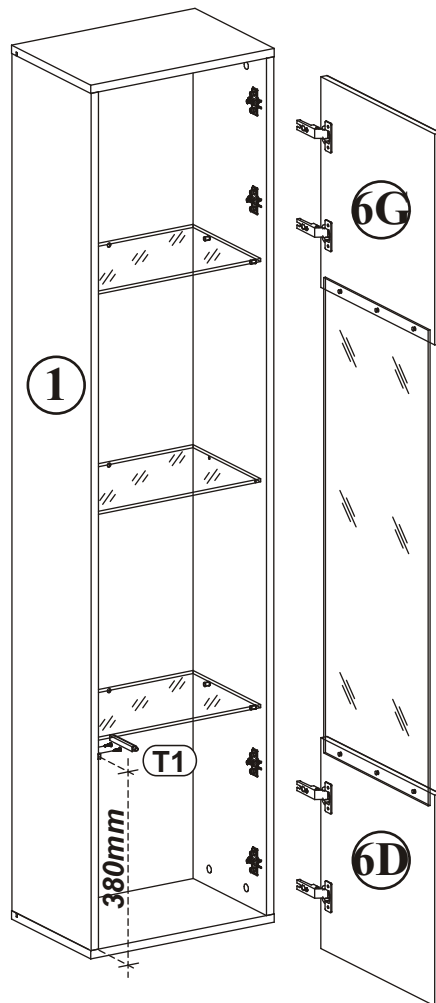
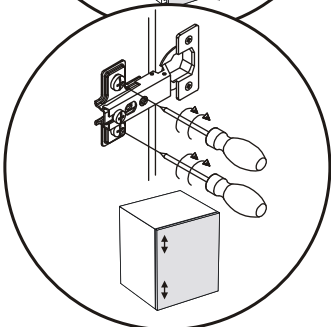
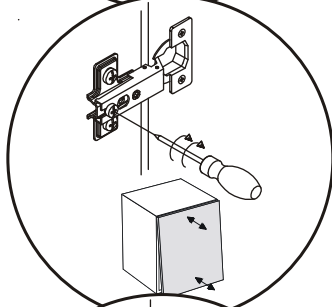
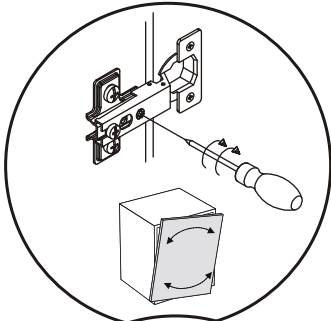

FLY TYP-42

10

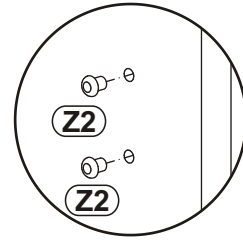
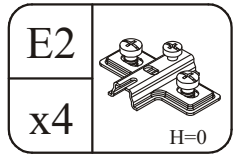
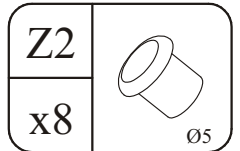
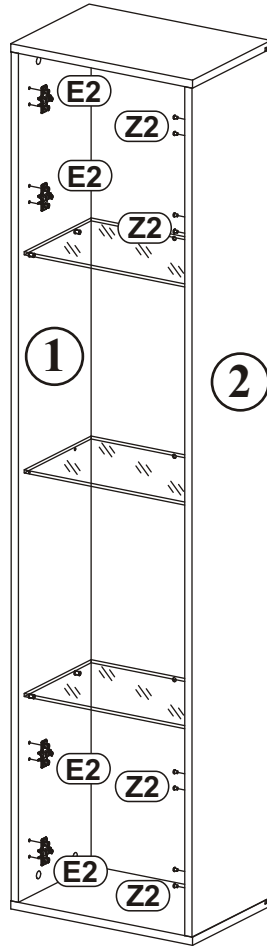
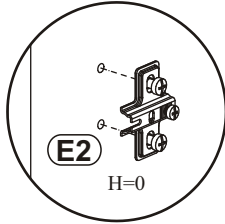
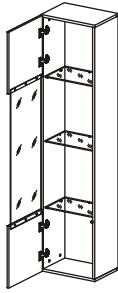

11

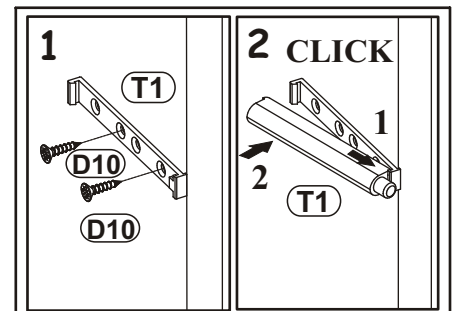
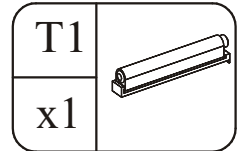
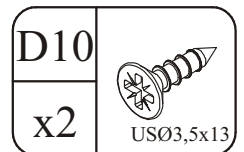
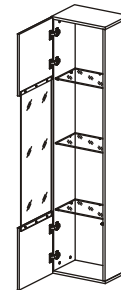
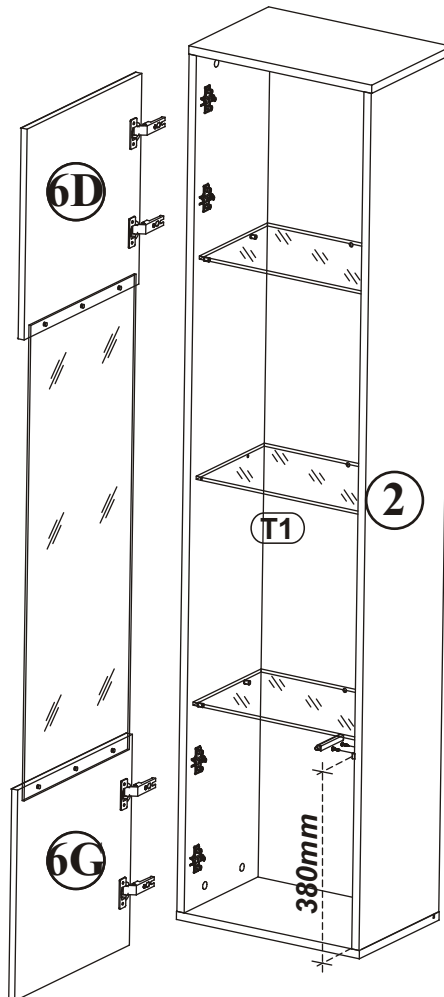
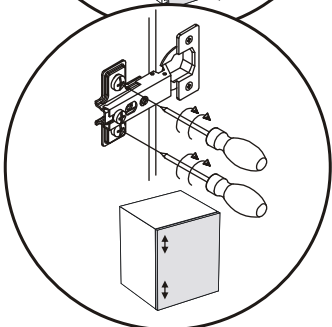
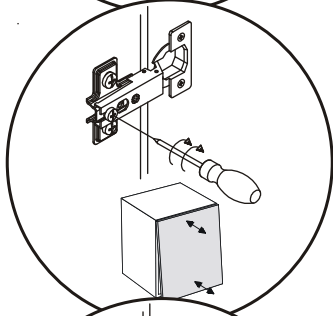
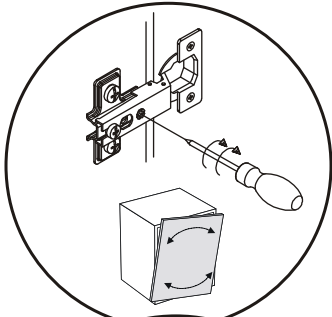



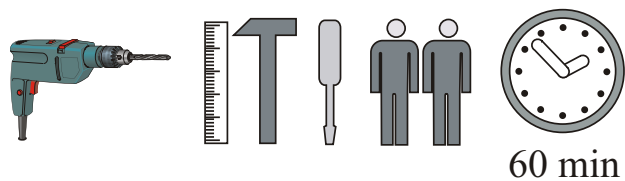
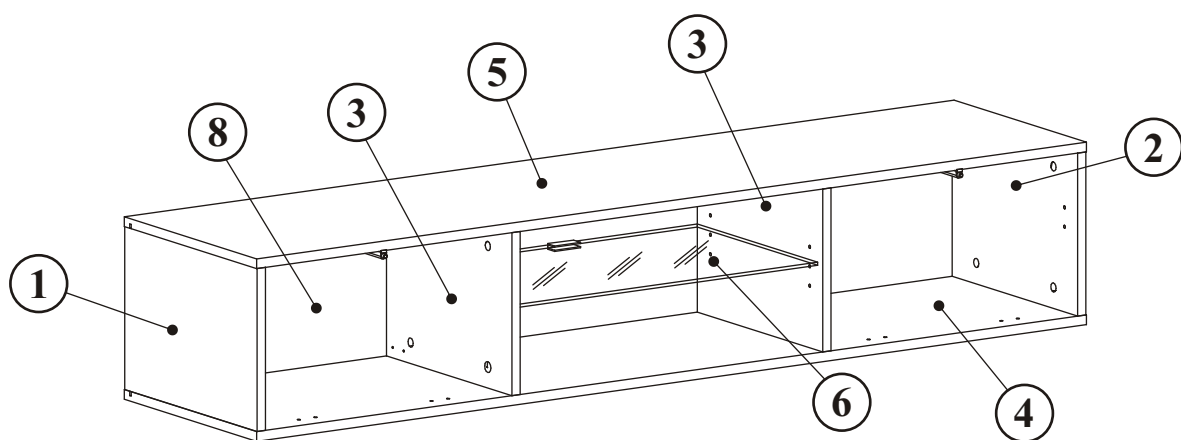
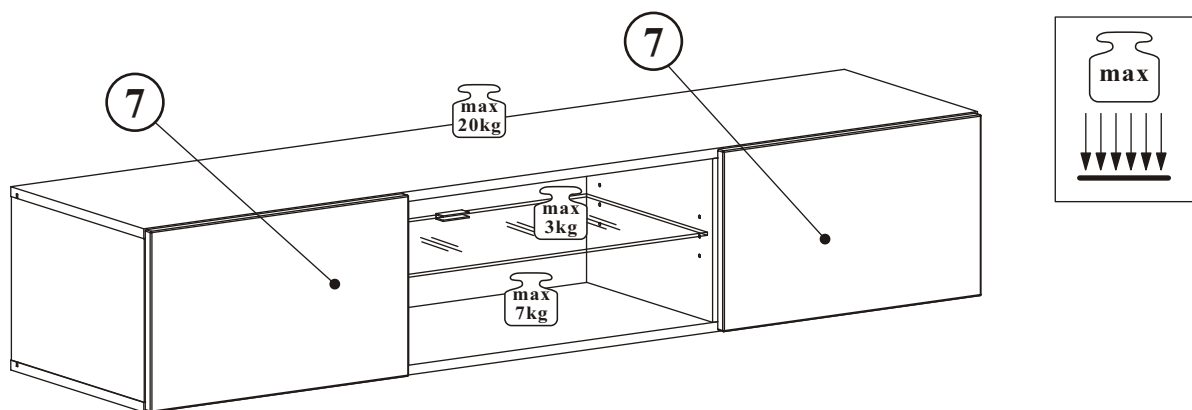





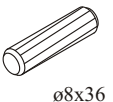
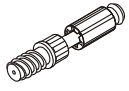

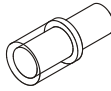

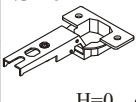
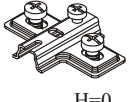
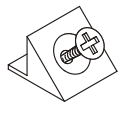
FLY TYP-33



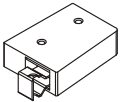

NO	Dim.			Col.-No	Qty
1	268	384	16	1	1
2	268	384	16	1	1
3	268	364	16	1	2
4	1602	384	16	1	1
5	1602	384	16	1	1
6	582	349	6	1	1
7	496	296	16	1	2
8	1580	280	3	1	1

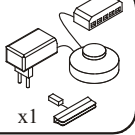
FLY TYP-33

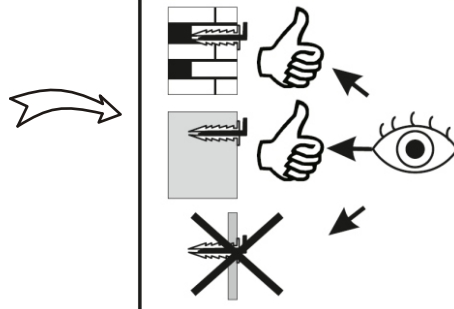
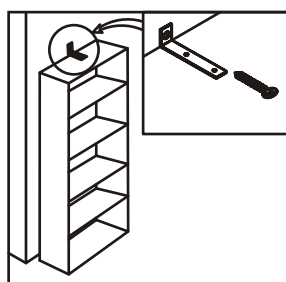
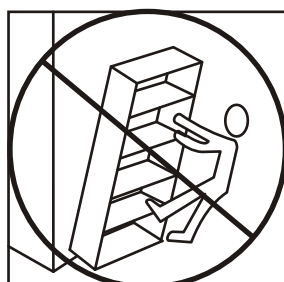
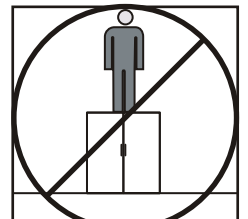
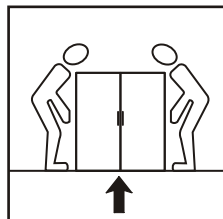
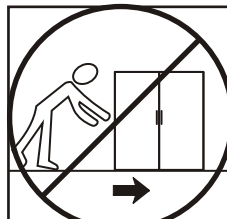
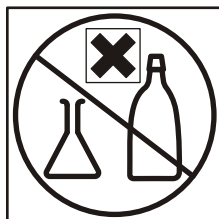
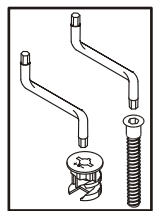
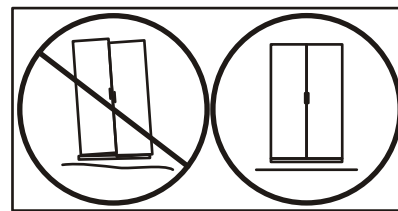
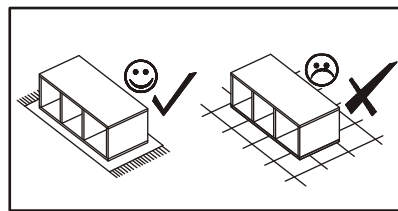
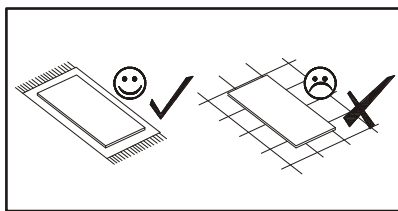
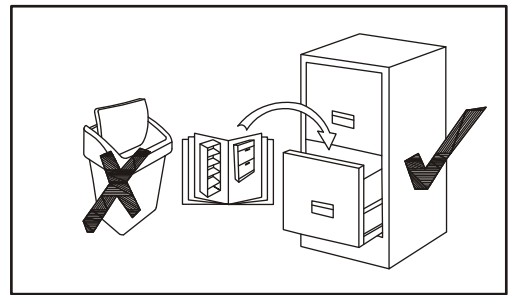
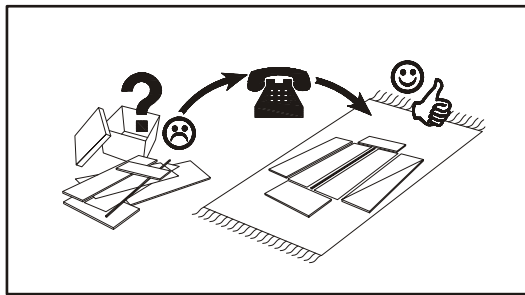
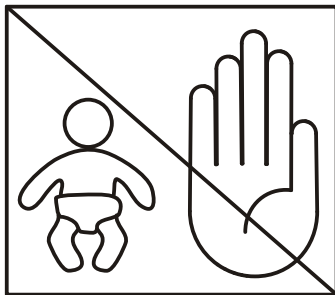
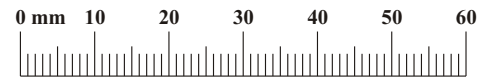
A1 x16  ø8x36	B4 x16 	B5 x16  ø15x12	G5 x16 	G20 x4 	G2 x1 
E1 x4 Ø26 H=0 	E2 x4 H=0 	S1 x12 	D6 x8 USØ3,5x30 	D10 x16 USØ3,5x13 	G21 x2 
ZR1 x4 	KR2 x4 	D7 x6 USØ3x16 	T1 x2 	LED x1 x1 	

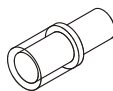
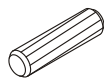

FLY TYP-33

G20		A1		B5	
x4		x16	ø8x36	x16	ø15x12

1

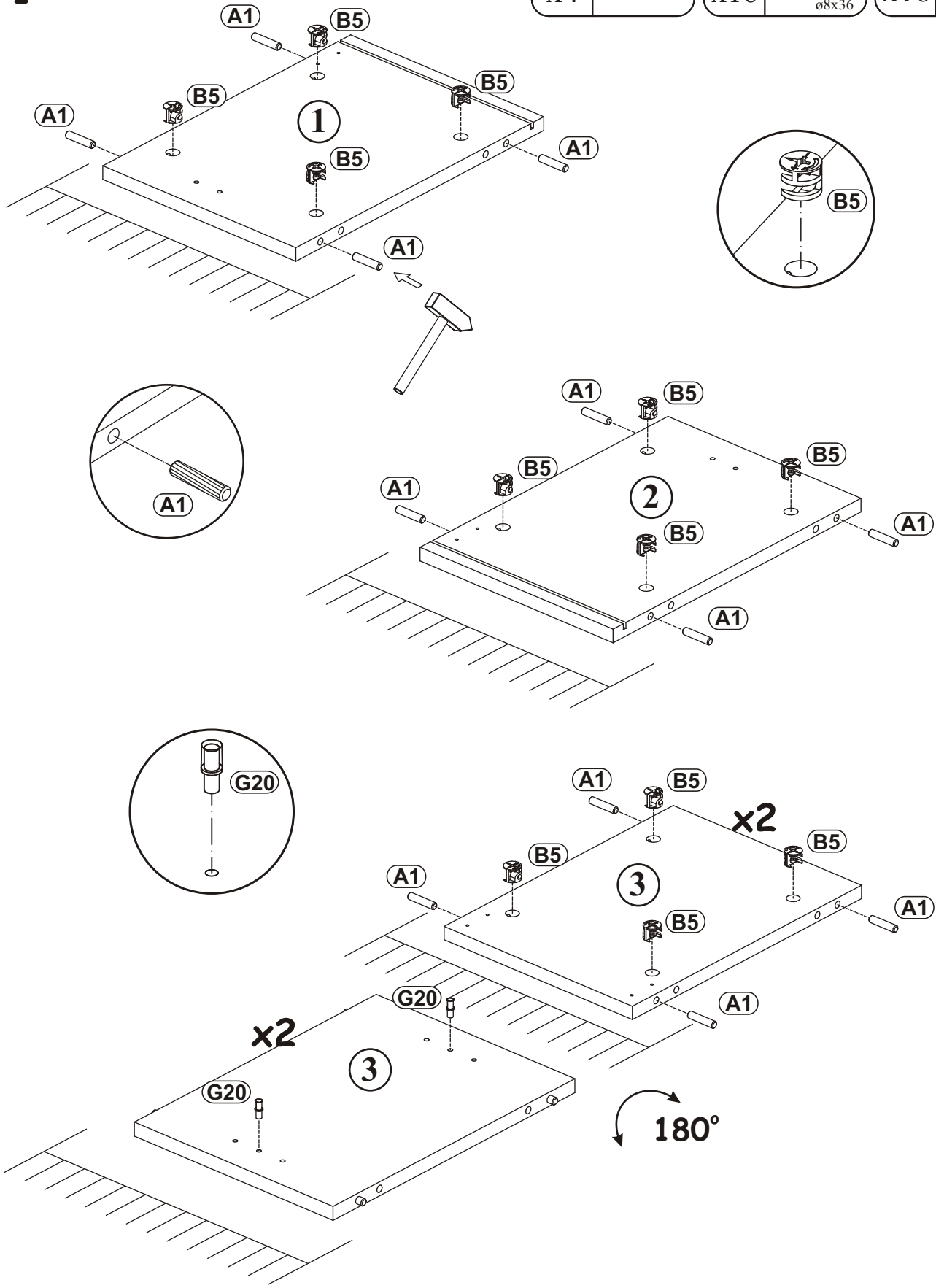

FLY TYP-33

2

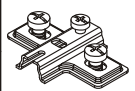
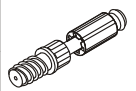
E2		B4	
x4	H=0	x16	

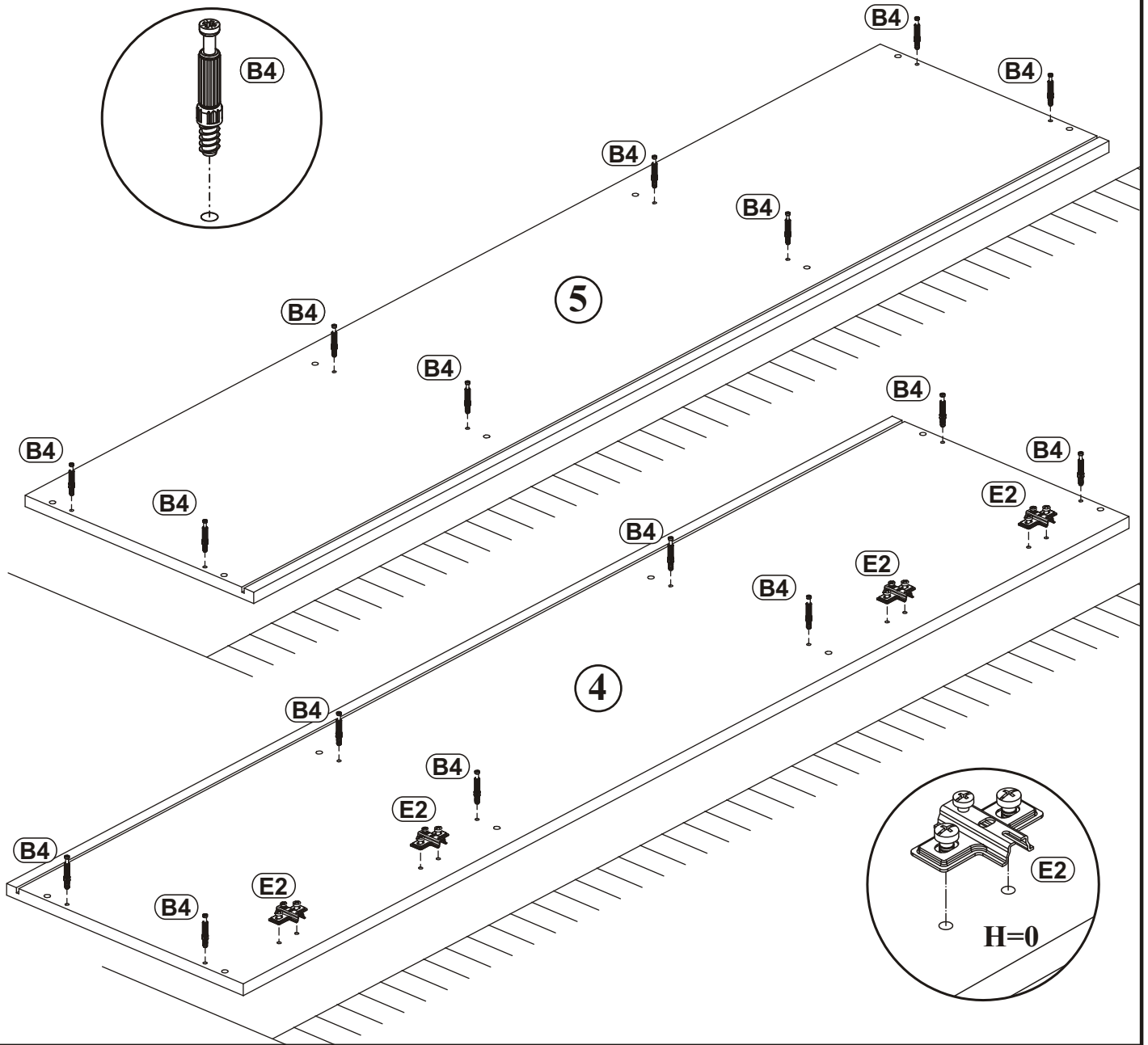

3

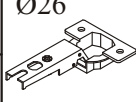
D10		E1	
x8	USØ3,5x13	x4	Ø26 H=0

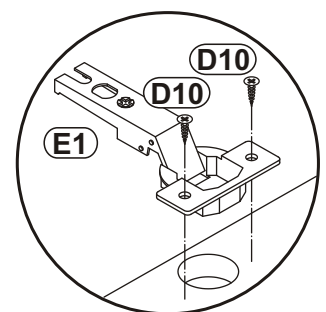
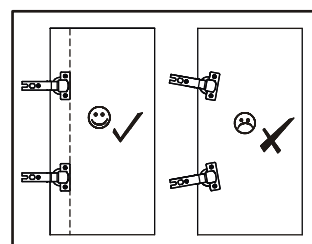
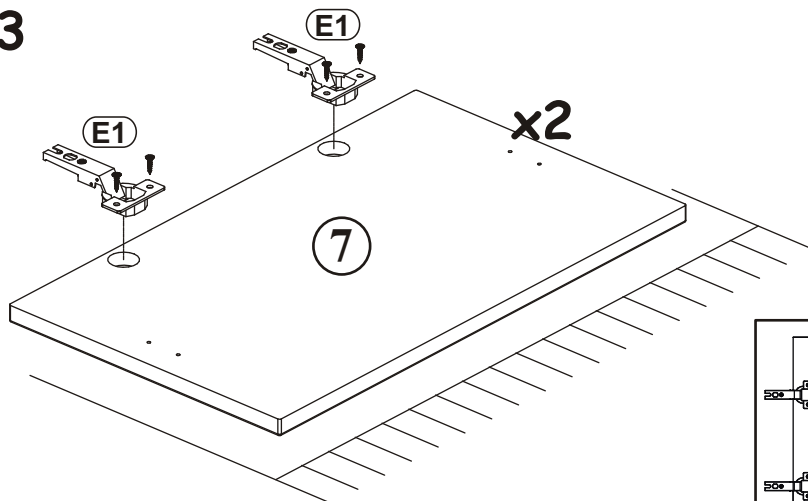

G5	
x16	

4

a)

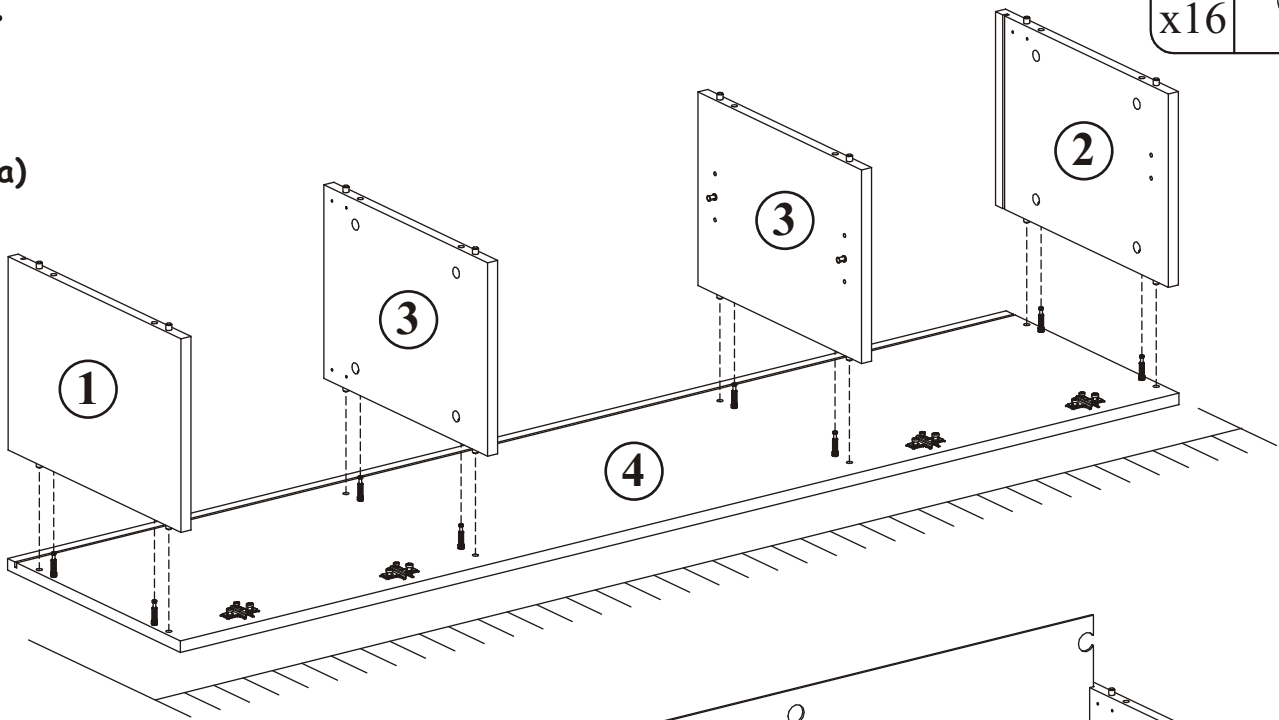

b)

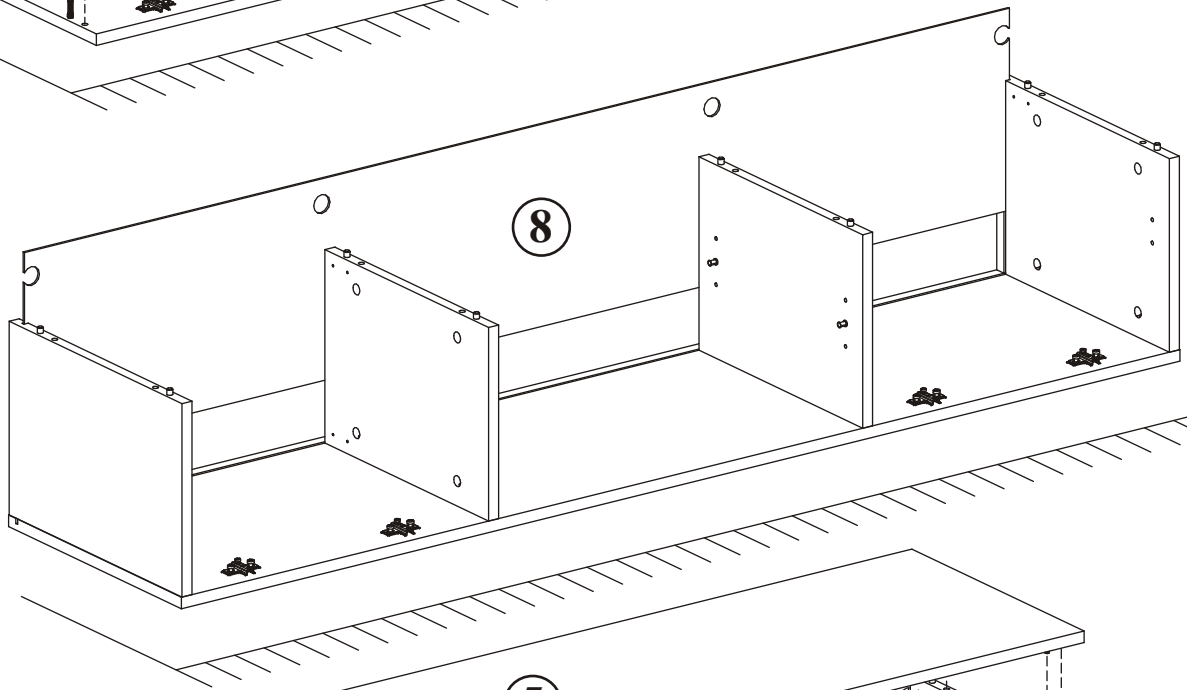

c)

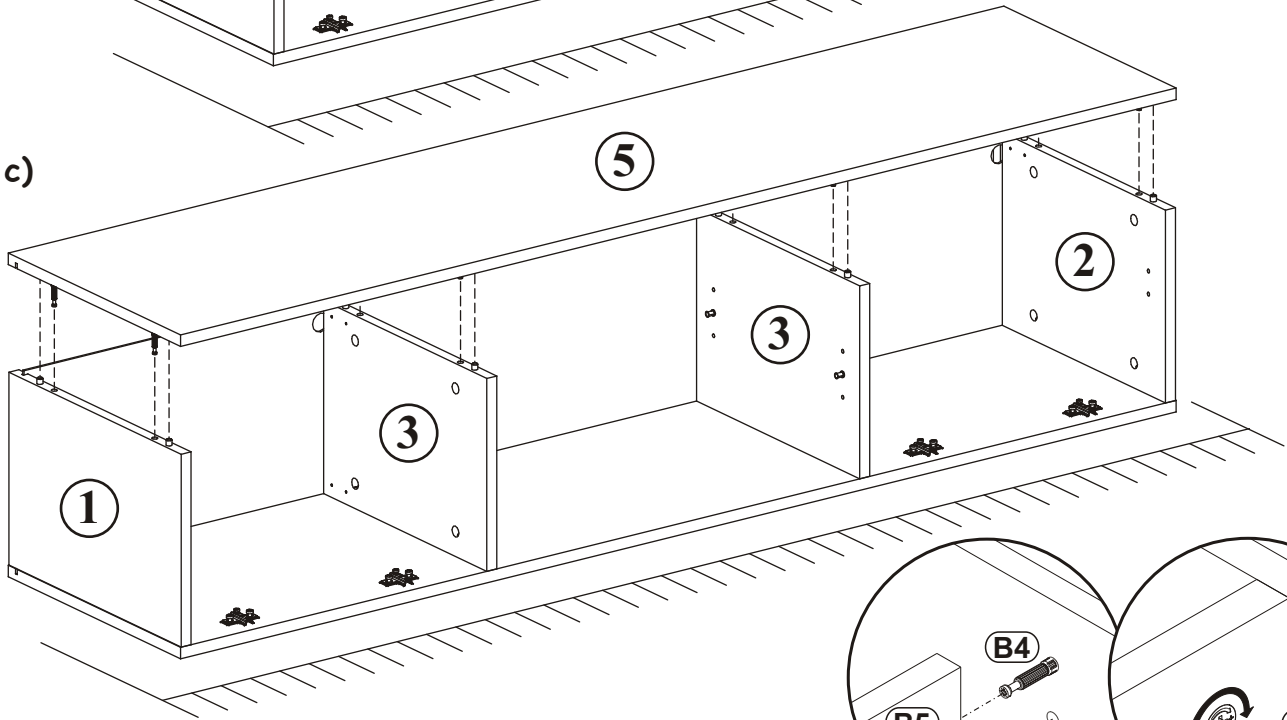

B4

B5

G5

5

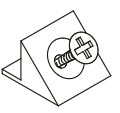
S1	
x12	

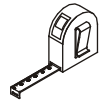

$X=Y$ 90°

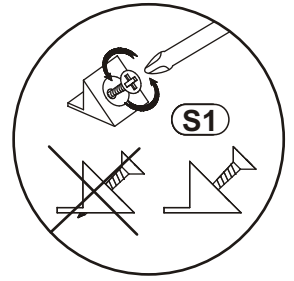
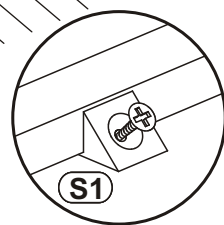
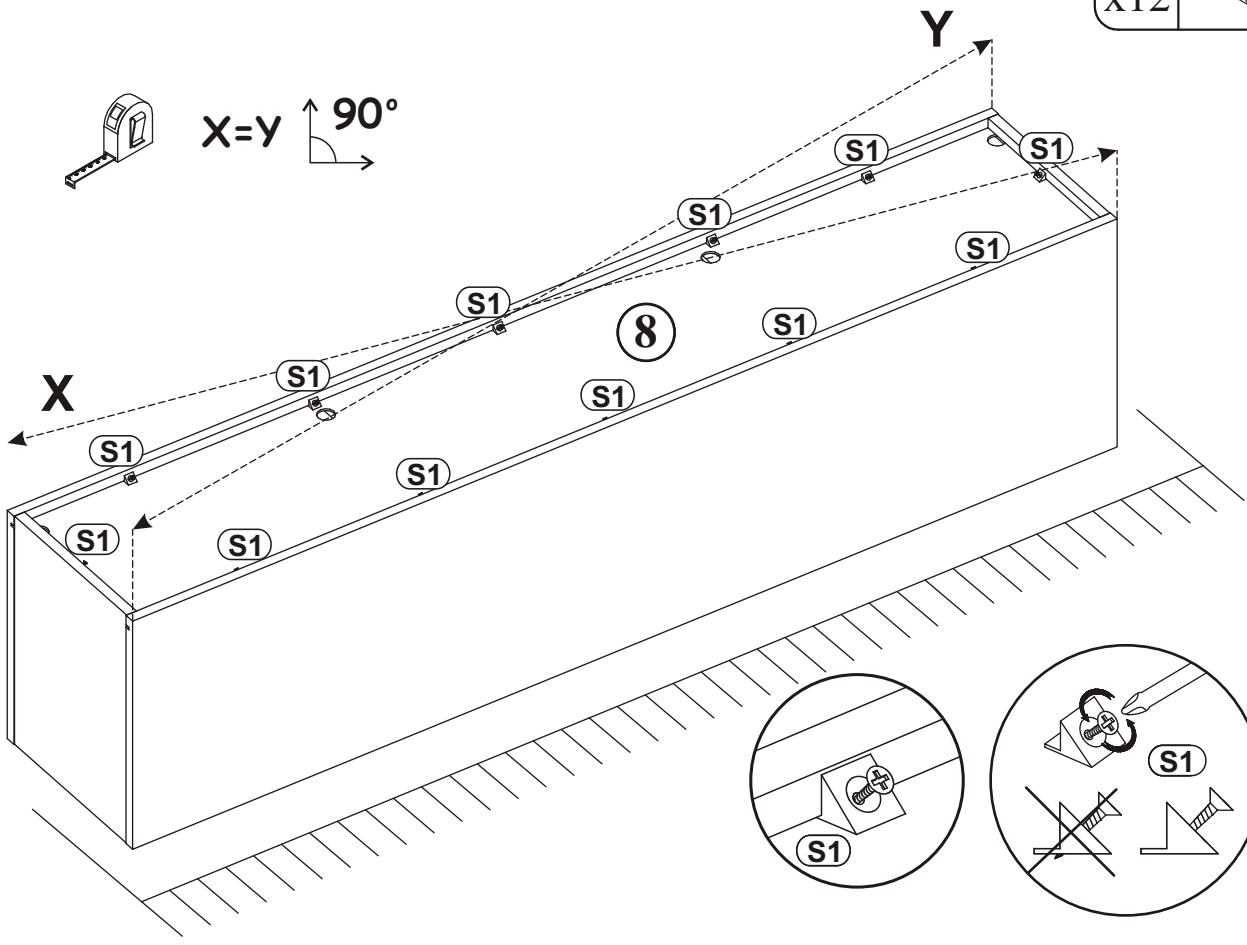

6

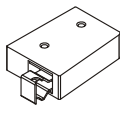
ZR1	
x4	

D6	
x8	USØ3,5x30

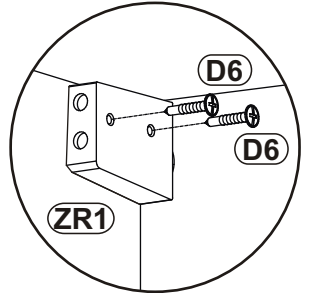
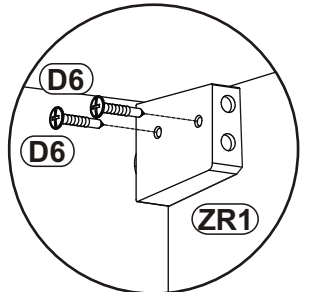
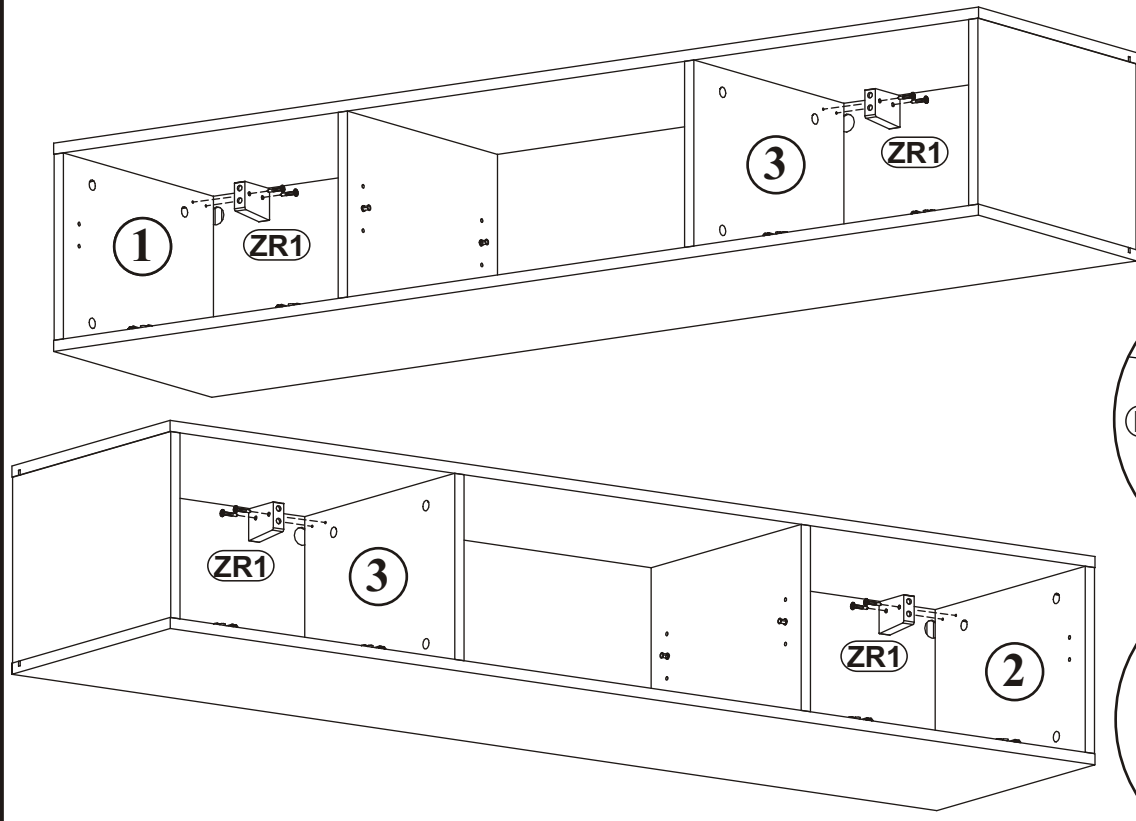

FLY TYP-33

7

T1		LED		D10	
x2		x1	x1	x4	USØ3,5x13

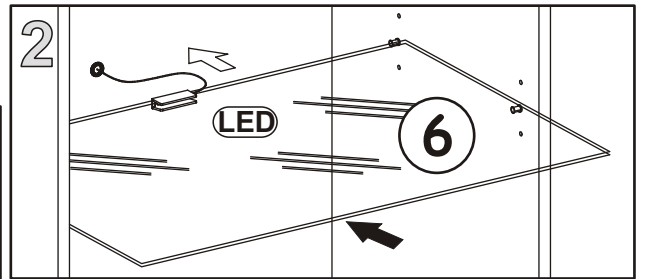
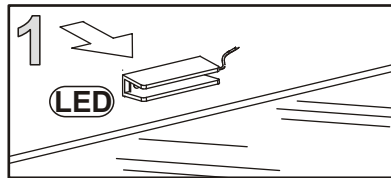
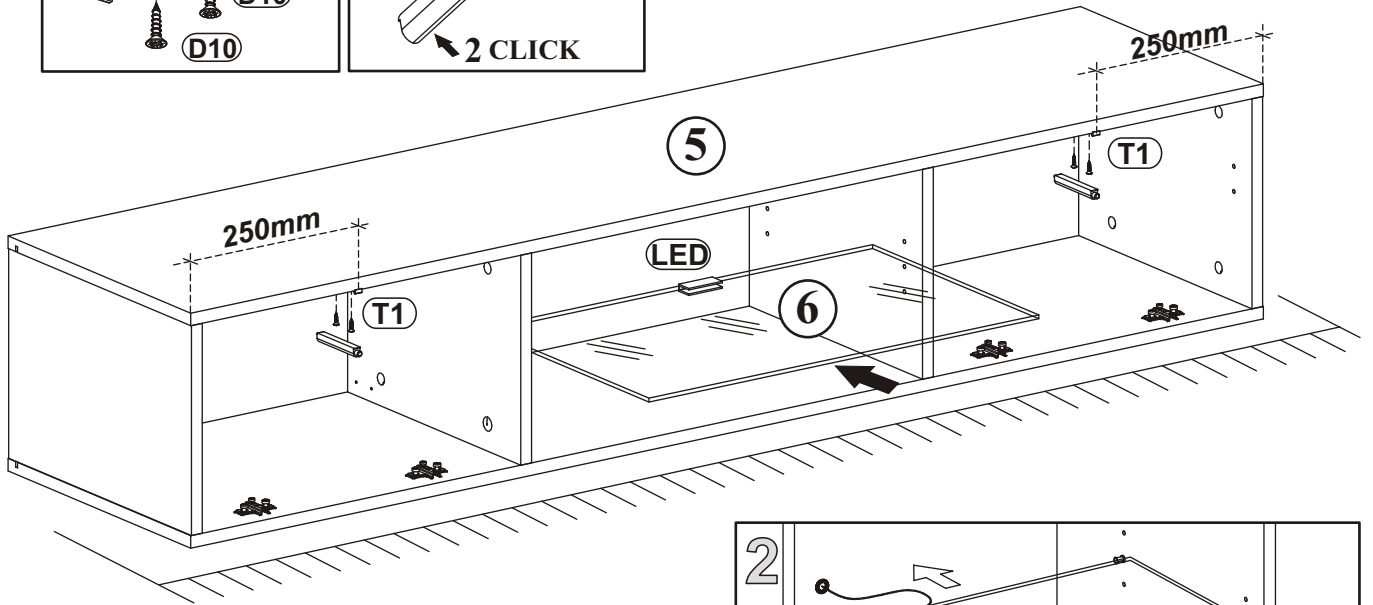
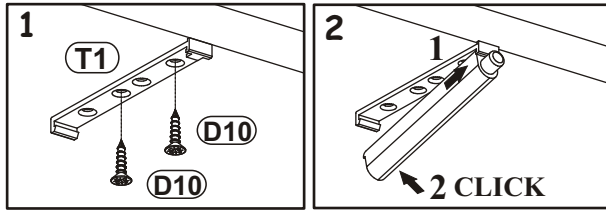

8

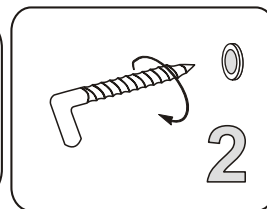
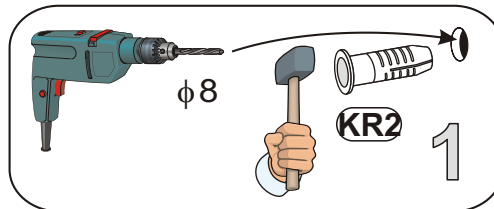
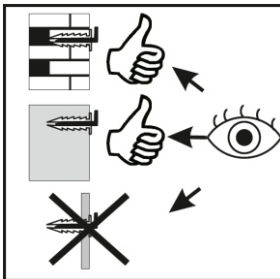

KR2	
x4	

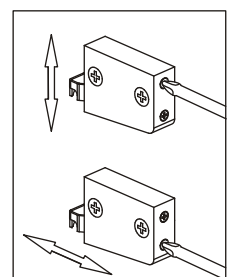
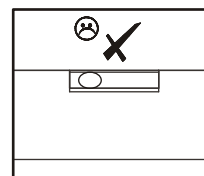
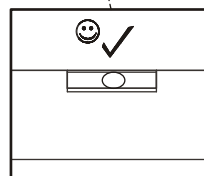
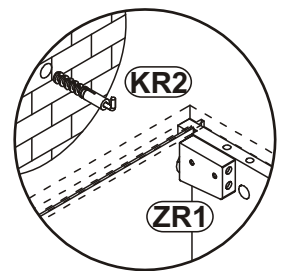
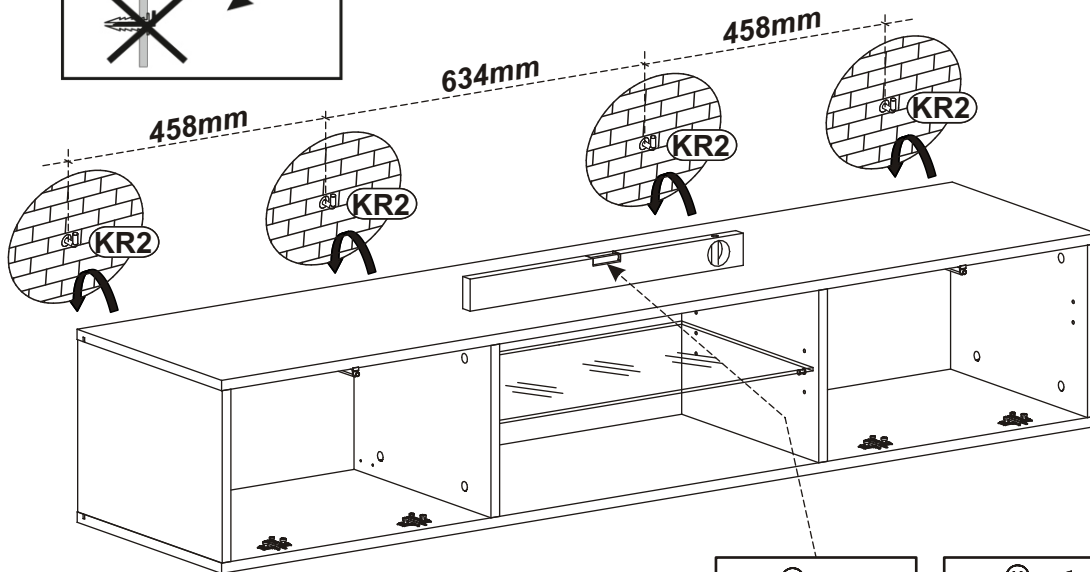

9

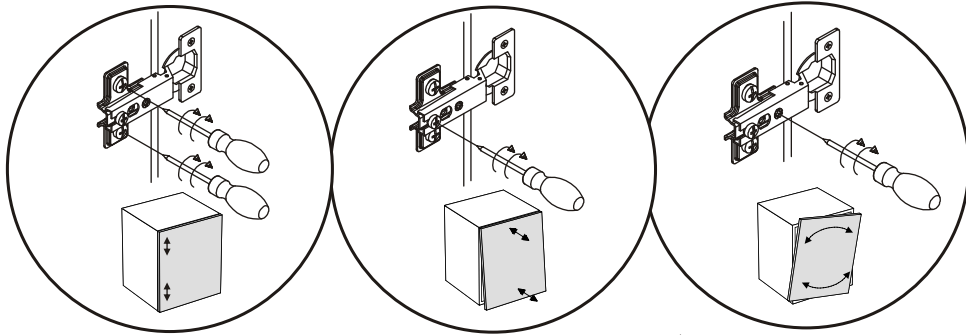
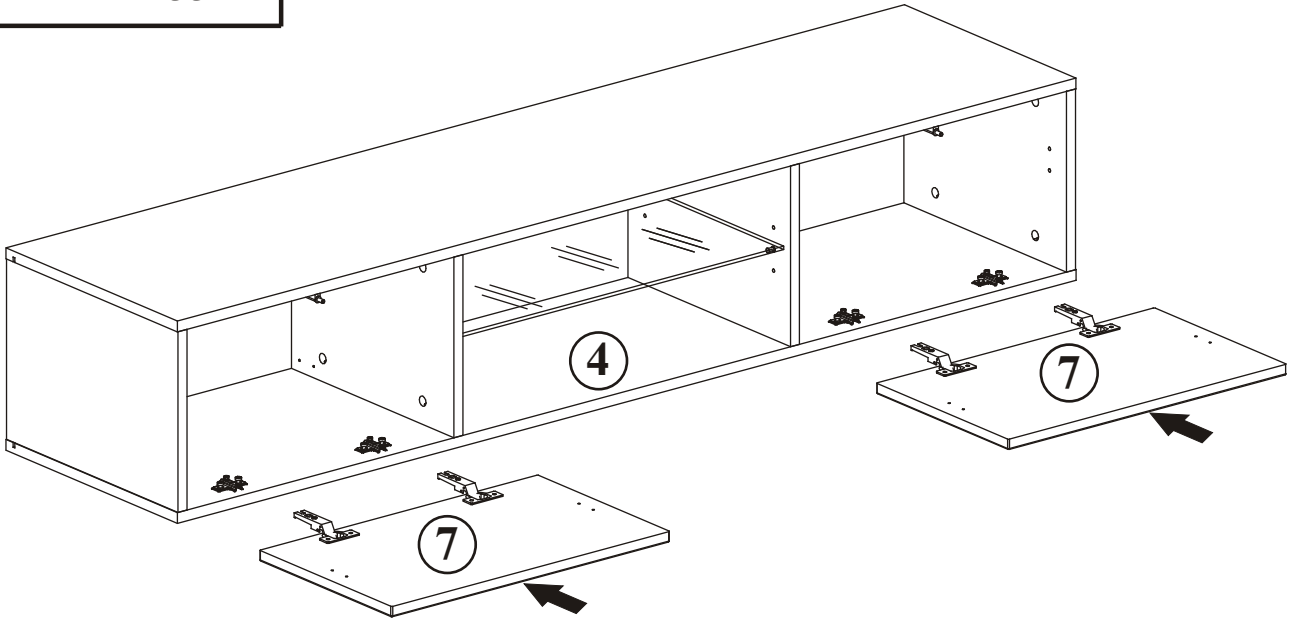

10

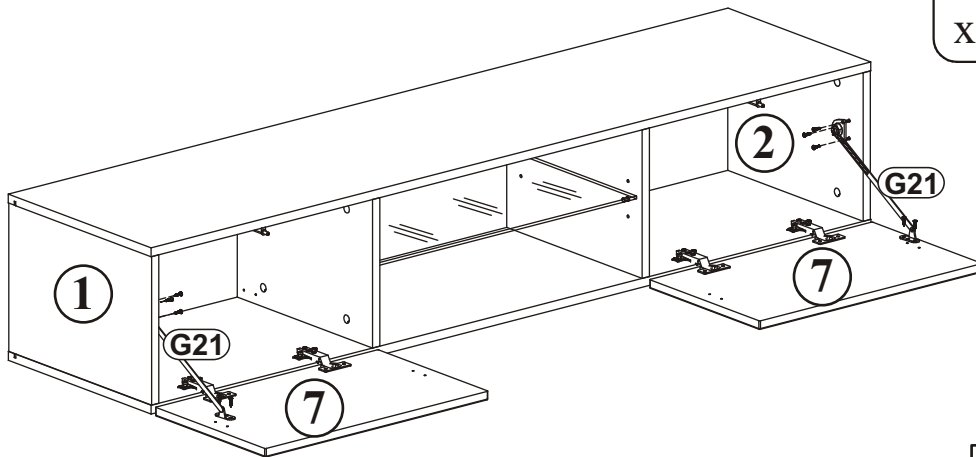

D10		G21	
x4	USØ3,5x13	x2	
D7			
x6	USØ3x16		

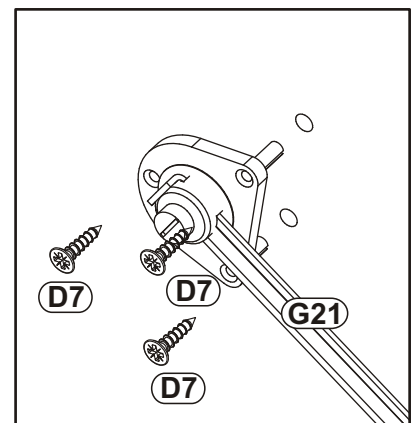
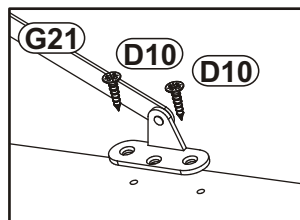



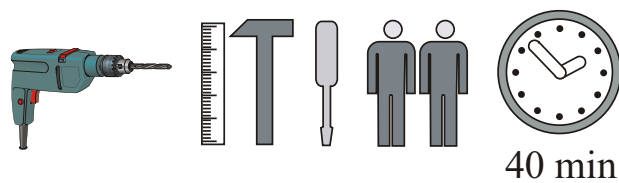
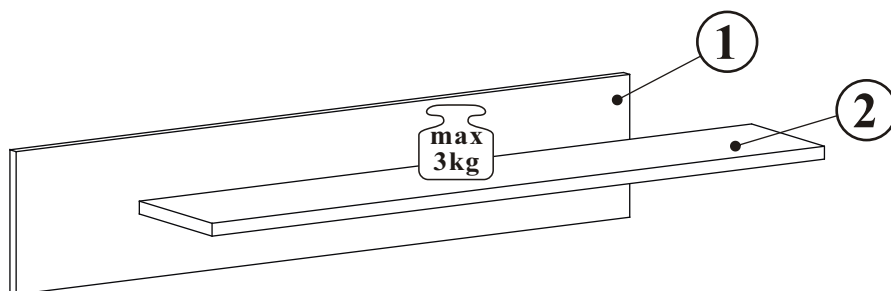
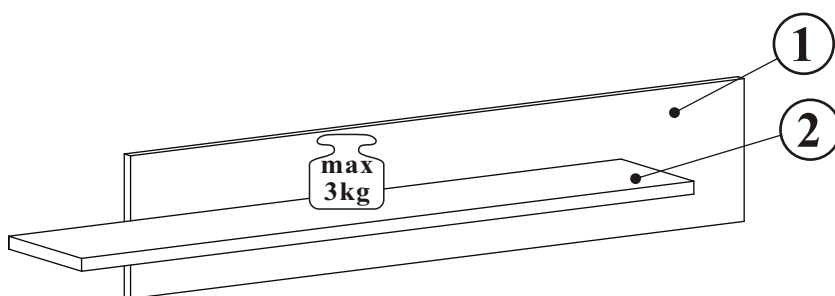
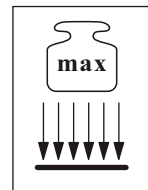
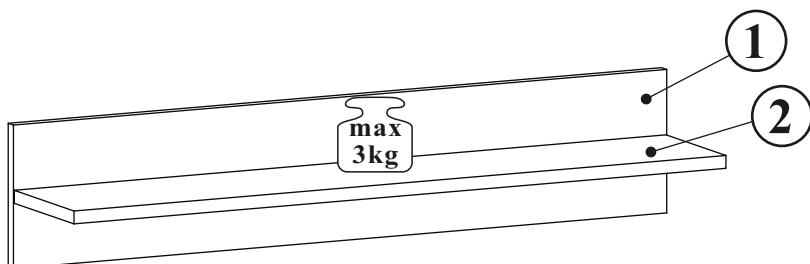



GALINO 23_MX

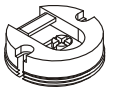

NO	Dim.		Col.-No	Qty
1	1002	200	1	2
2	1000	185	1	2

GALINO 23_MX

ZM1		D20		B11		G4		KR2		G2	
x4		x8	ESØ6x9,5	x12	Ø7x50	x12		x4		x1	

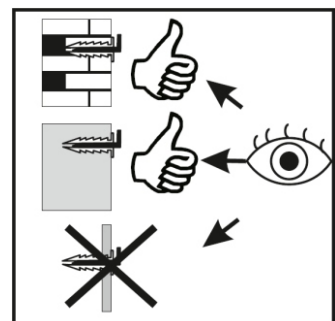
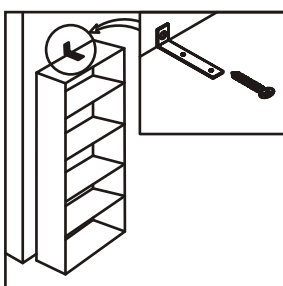
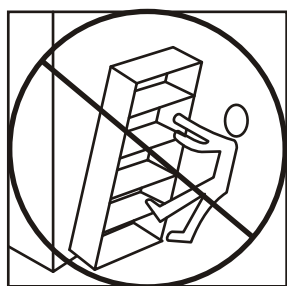
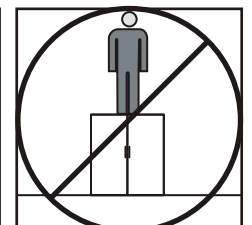
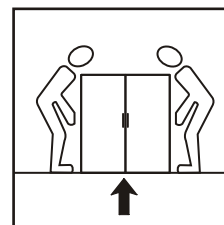
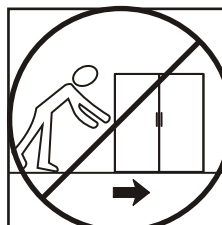
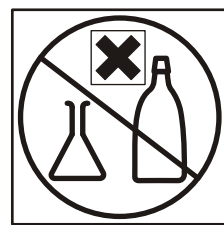
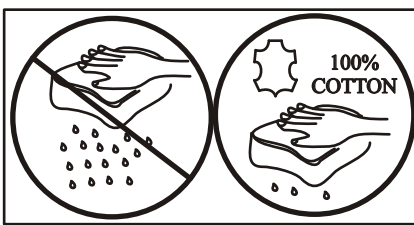
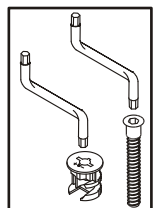
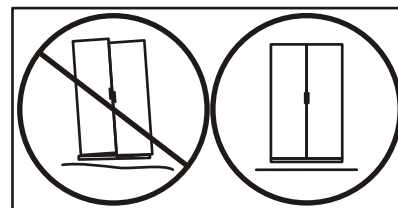
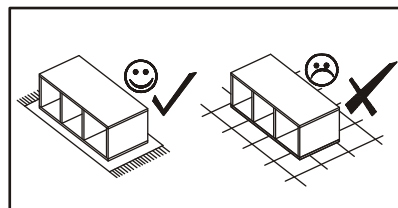
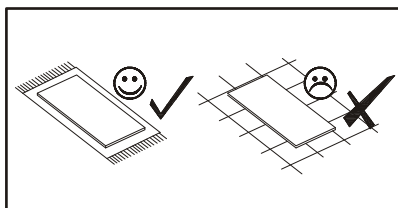
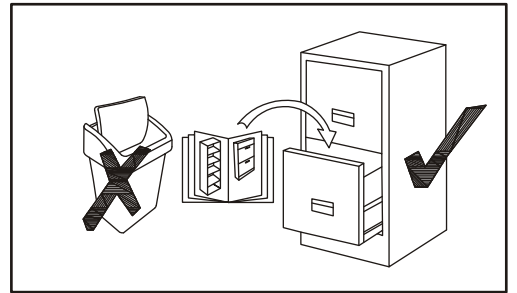
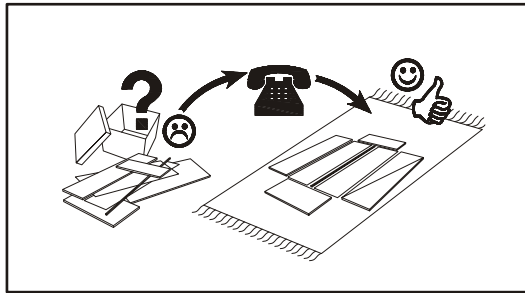
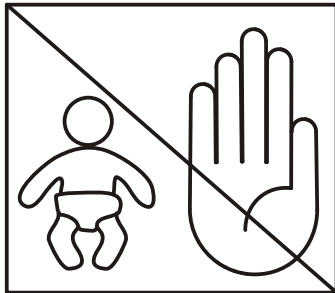
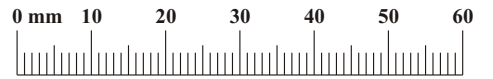

1-3

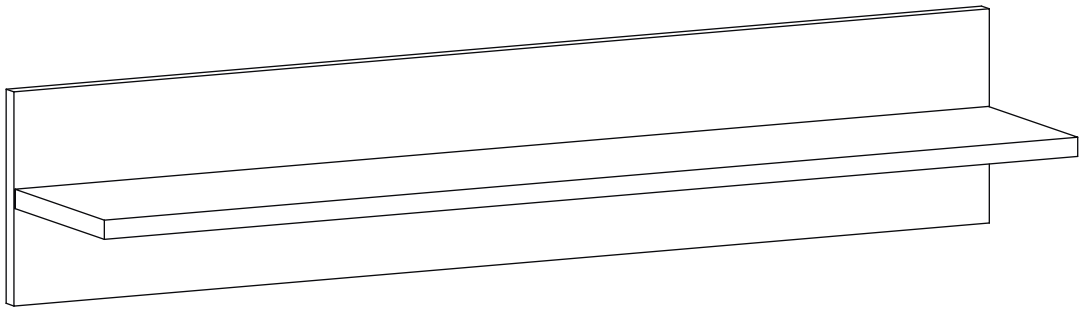

4-6

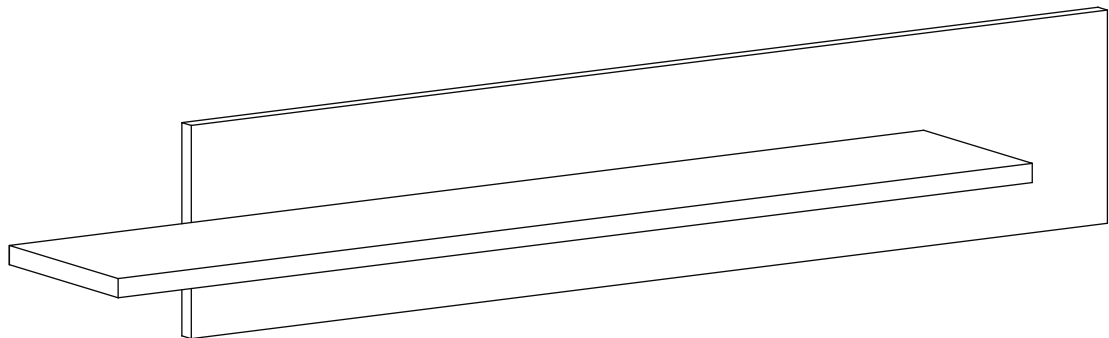

7-9

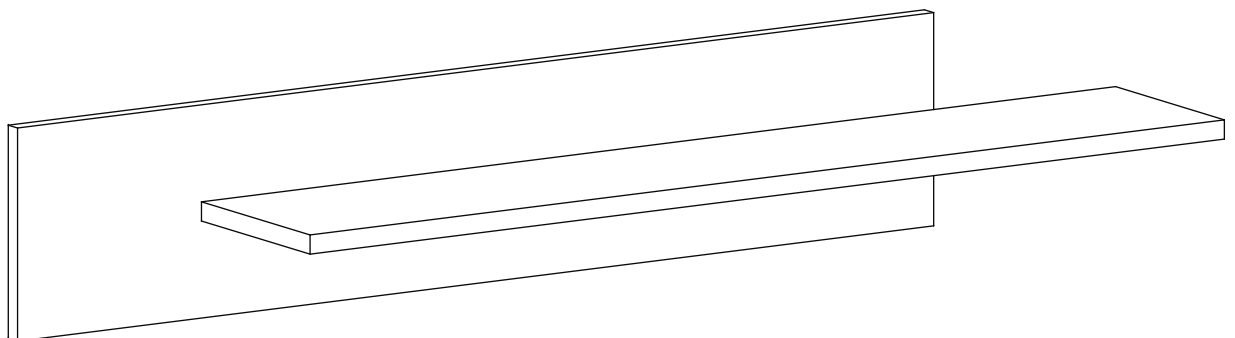

GALINO 23_MX

1

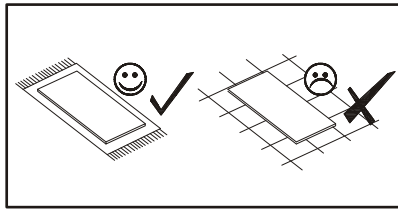

ZM1
x4

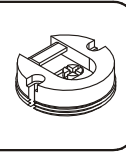

D20
x8

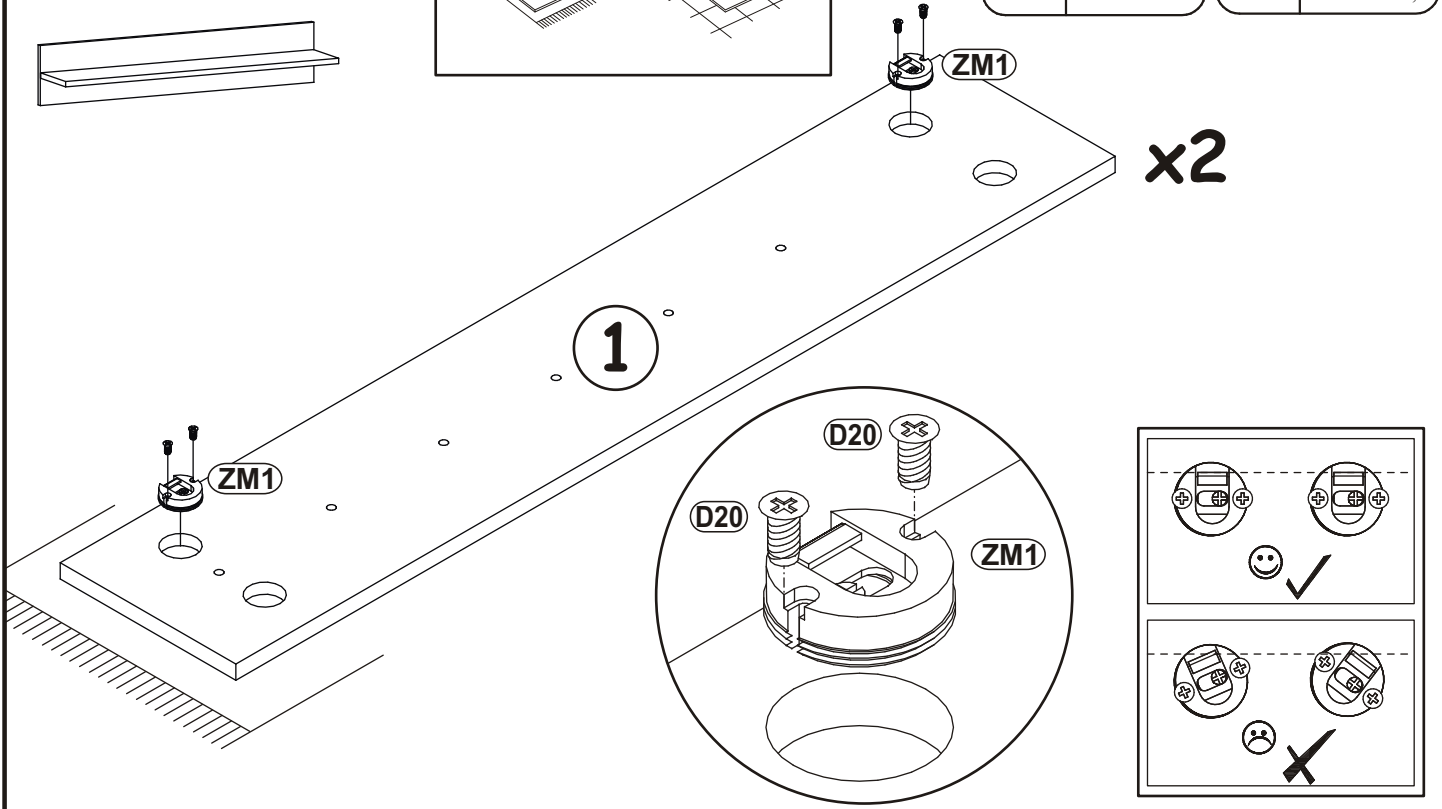
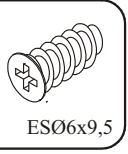

2

B11
x12

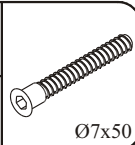

G4
x12

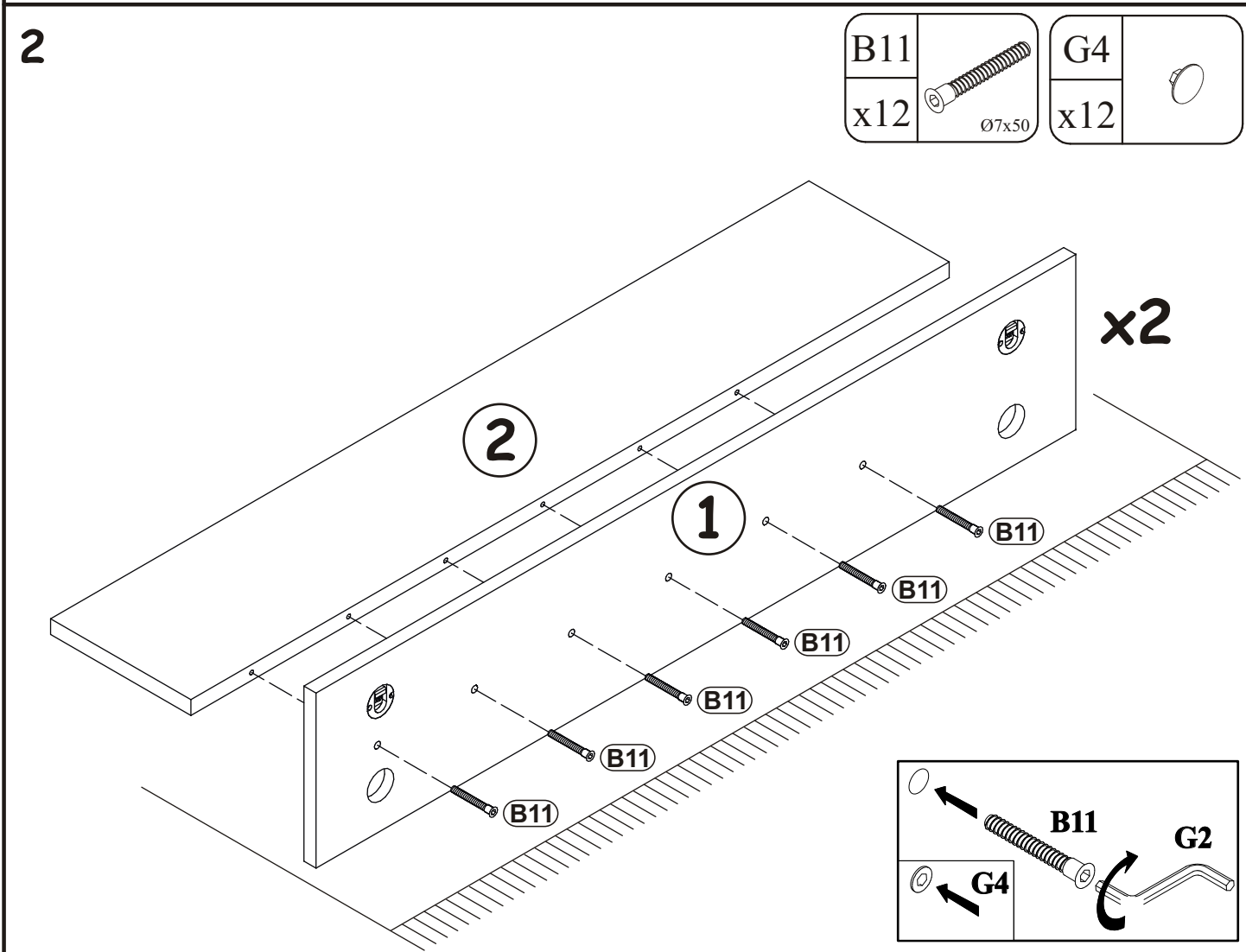
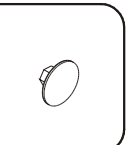

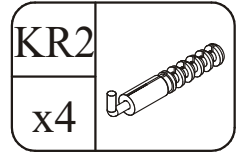

3

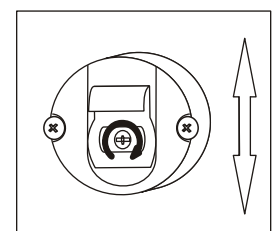
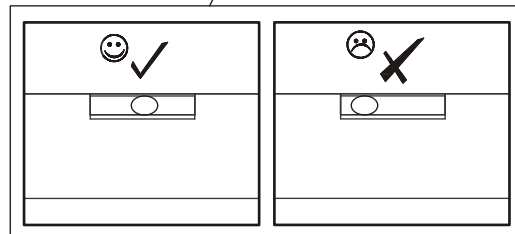
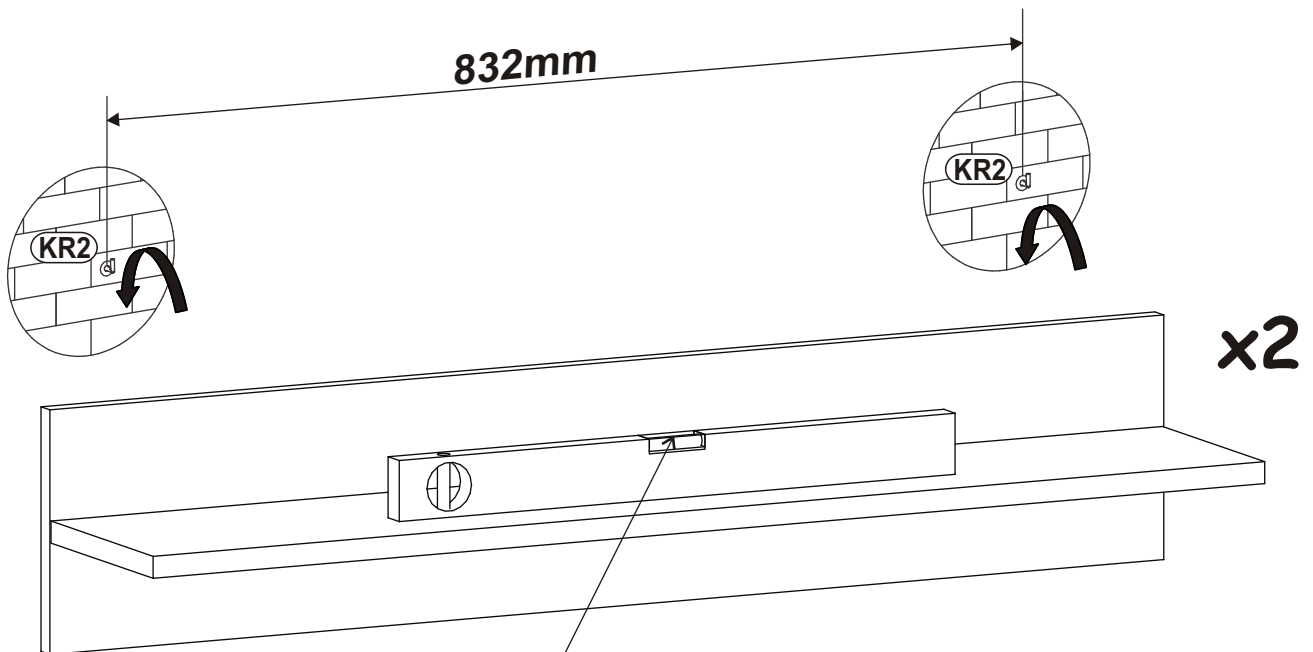
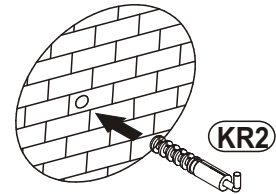
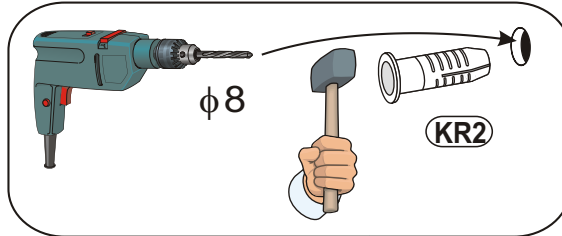
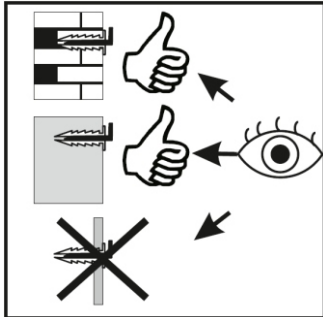

4

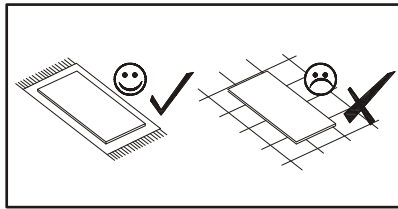

ZM1		D20	
x4		x8	ESØ6x9,5

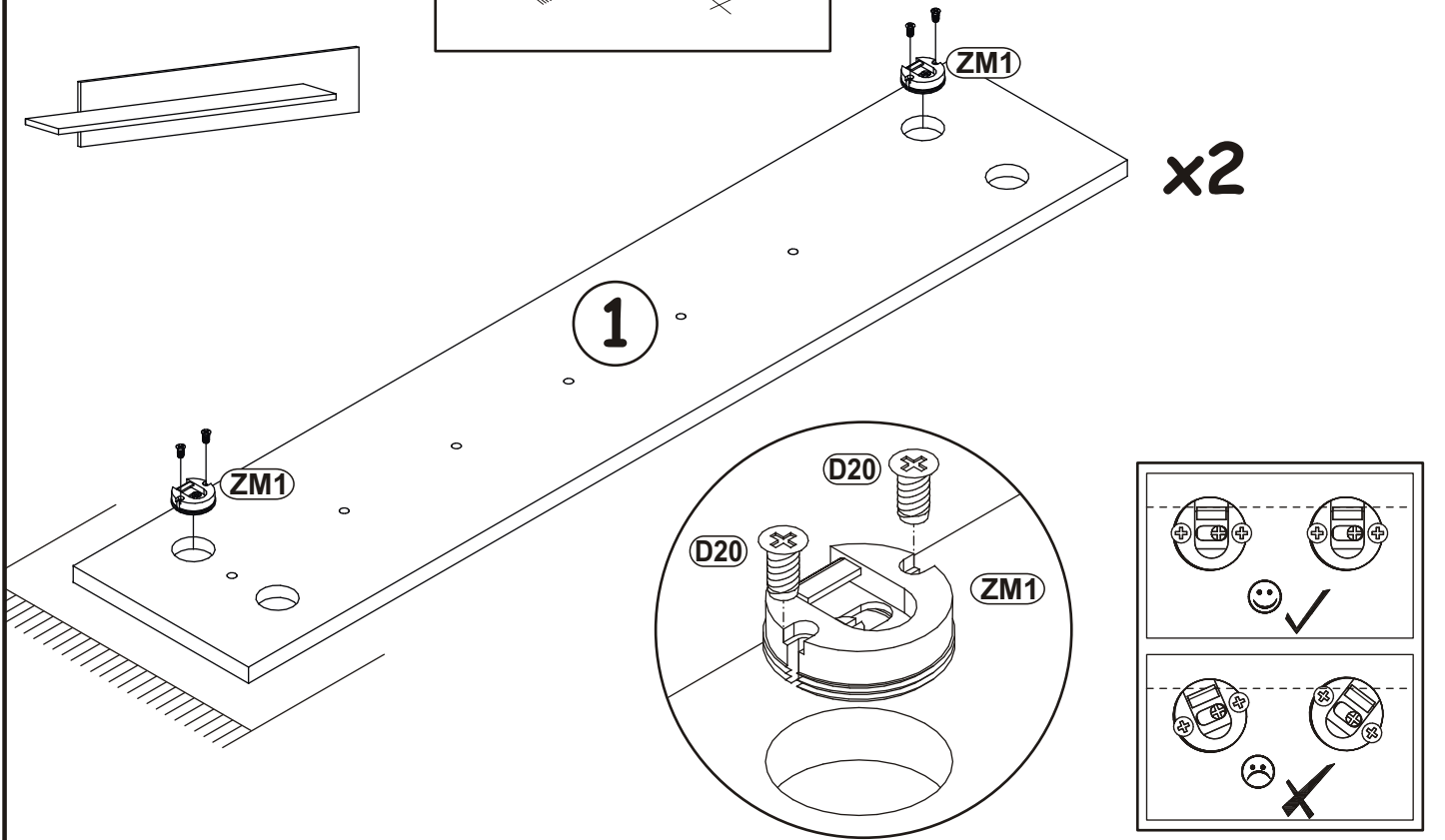

5

B11		G4	
x12	Ø7x50	x12	

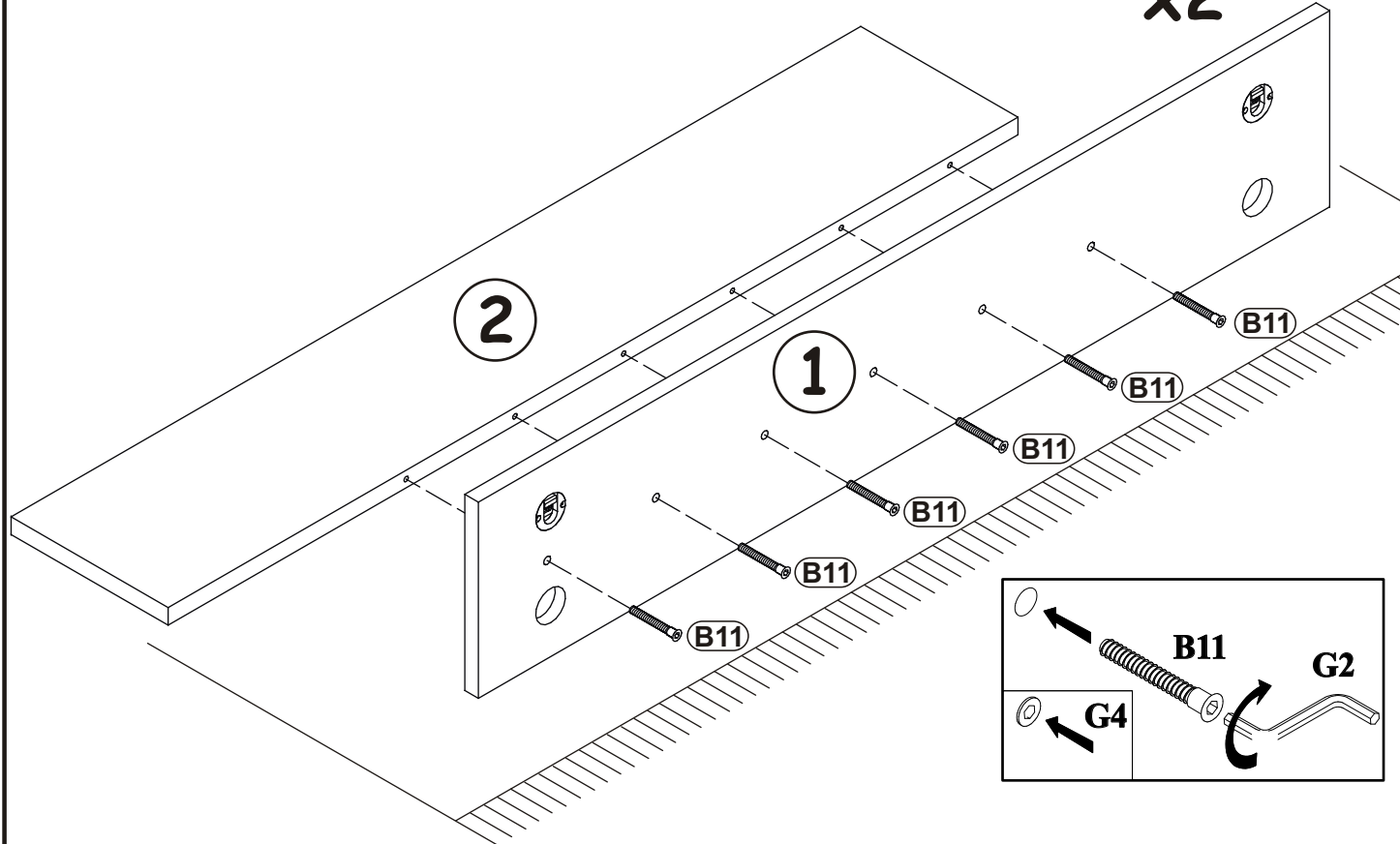

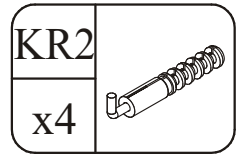

6

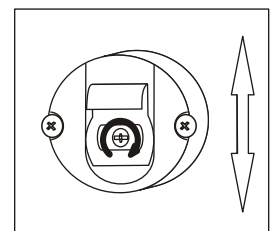
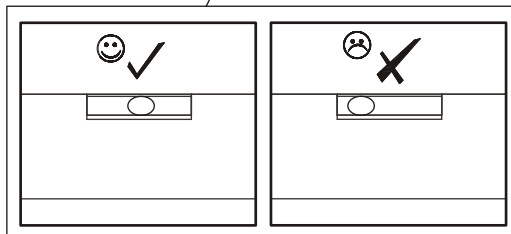
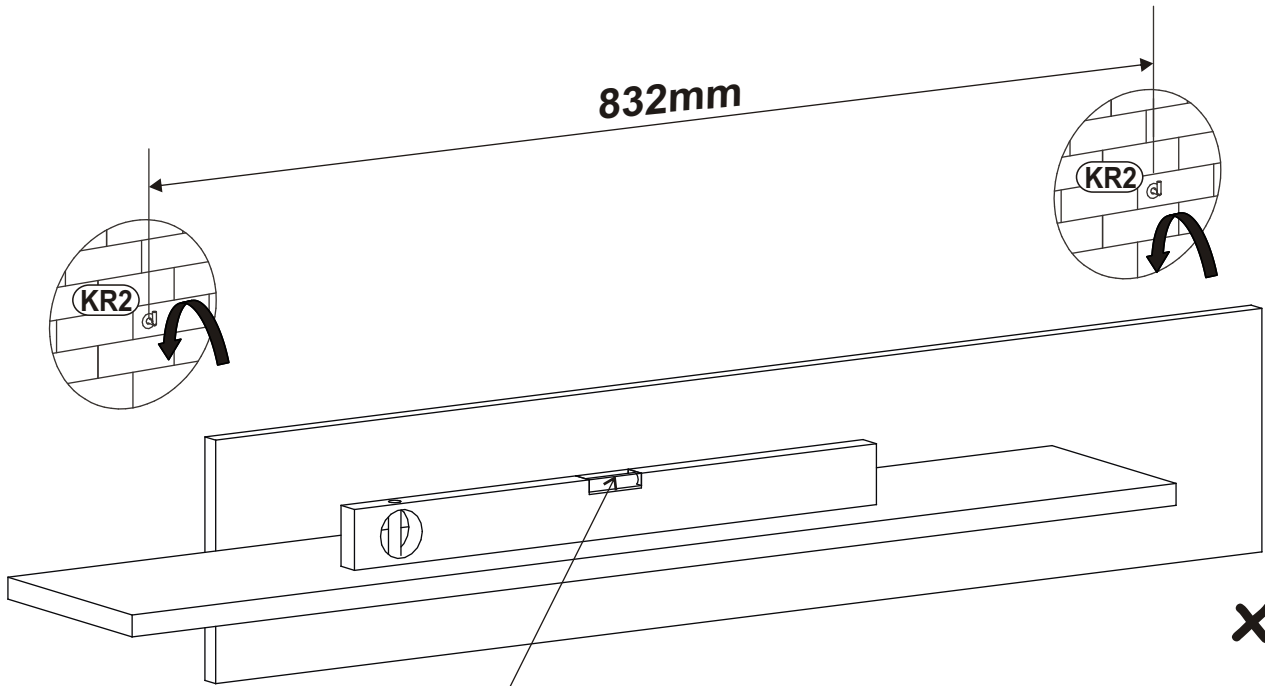
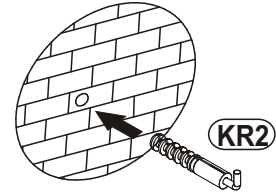
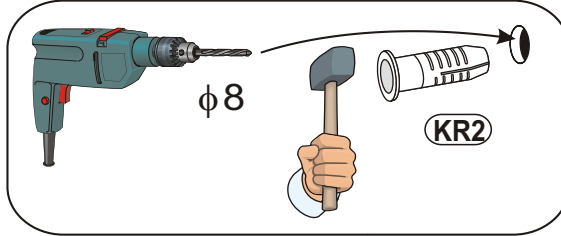
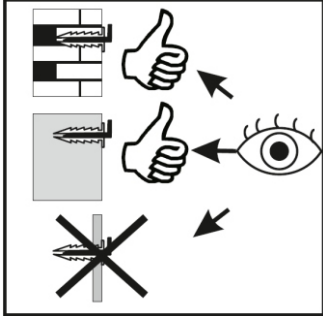

7

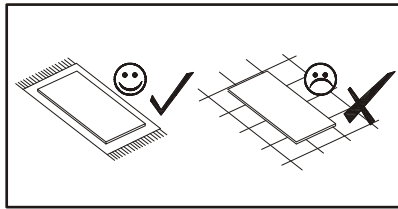

ZM1		D20	
x4		x8	ESØ6x9,5

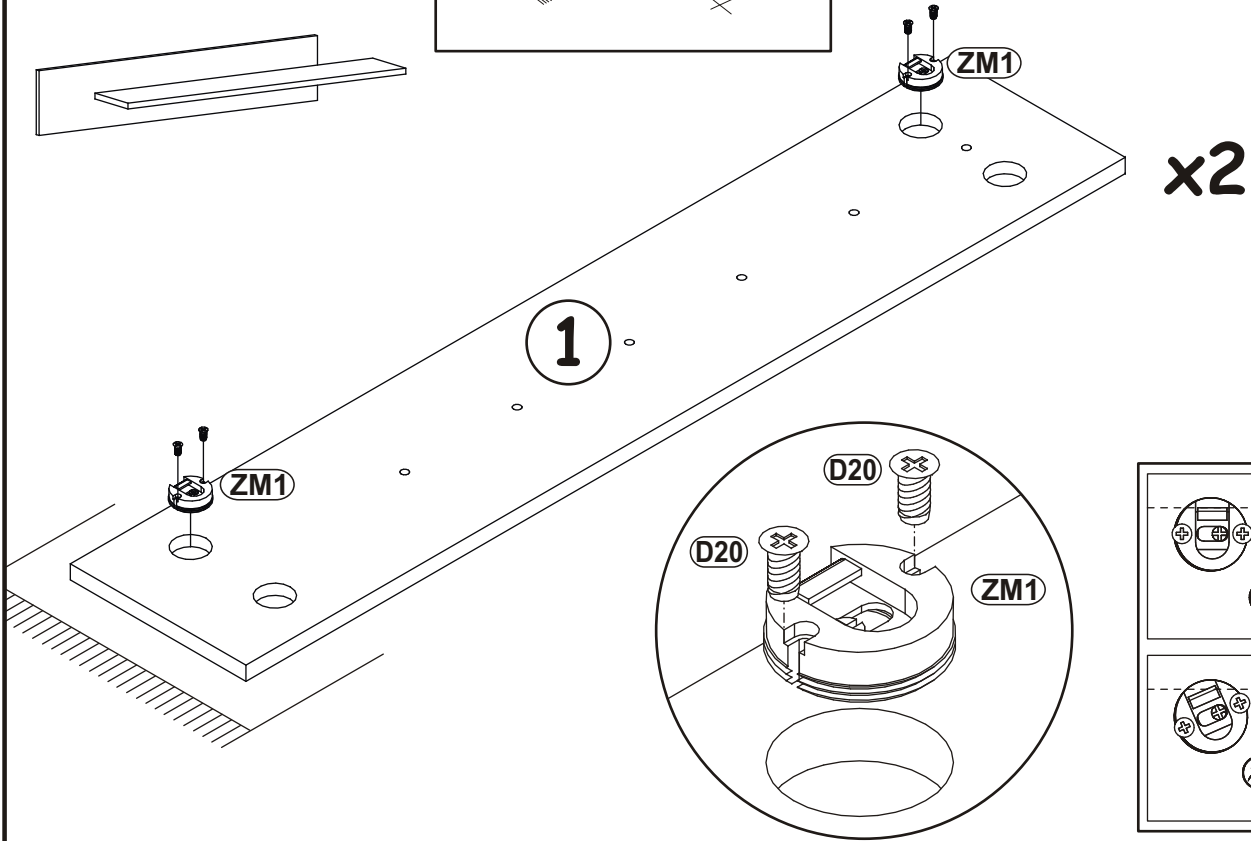

8

B11		G4	
x12	Ø7x50	x12	

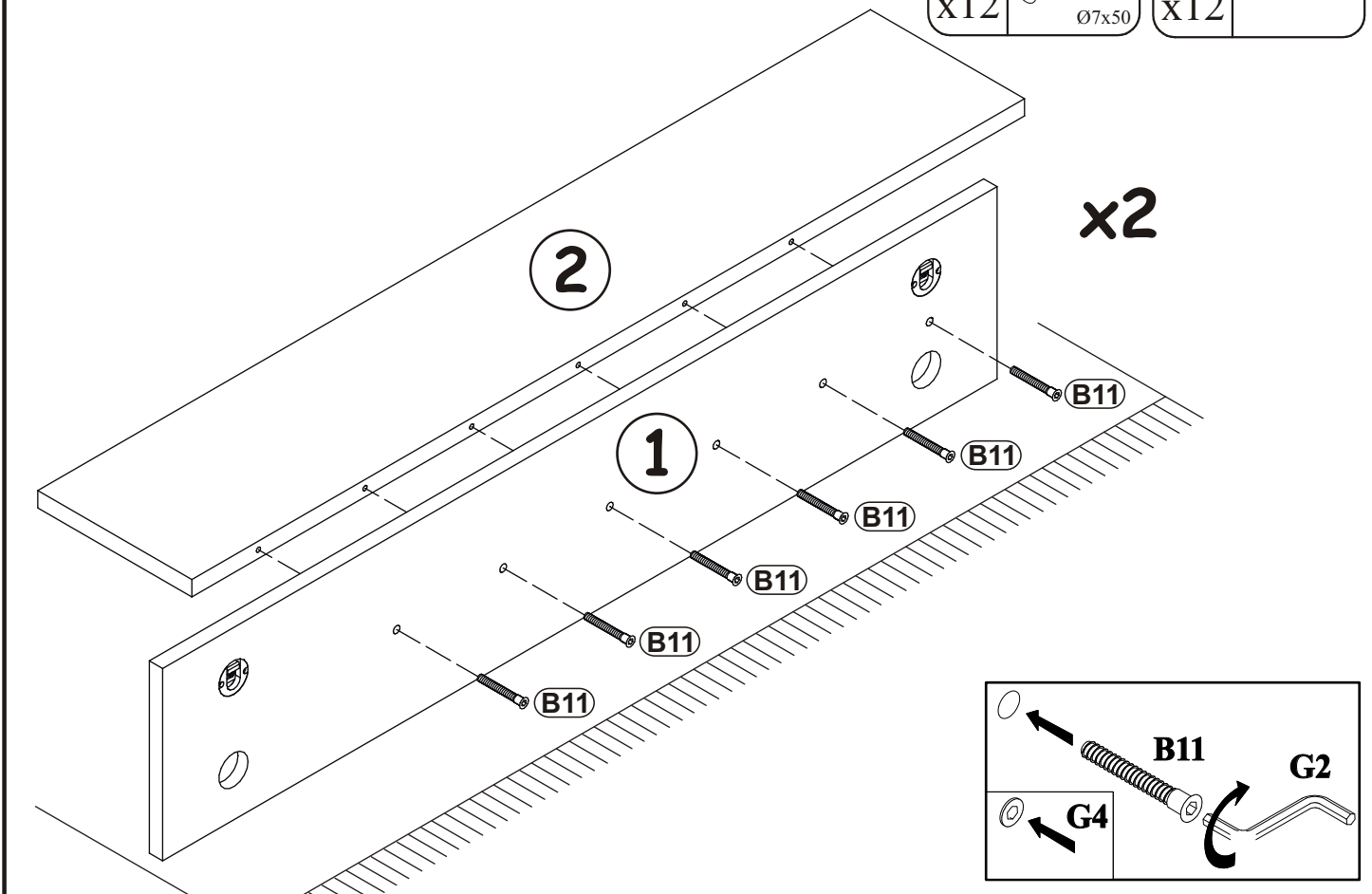

9

