

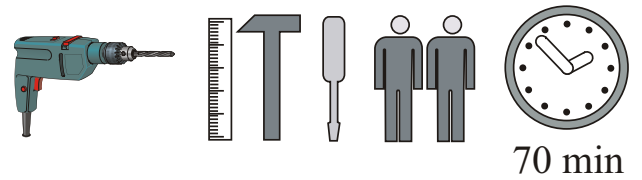

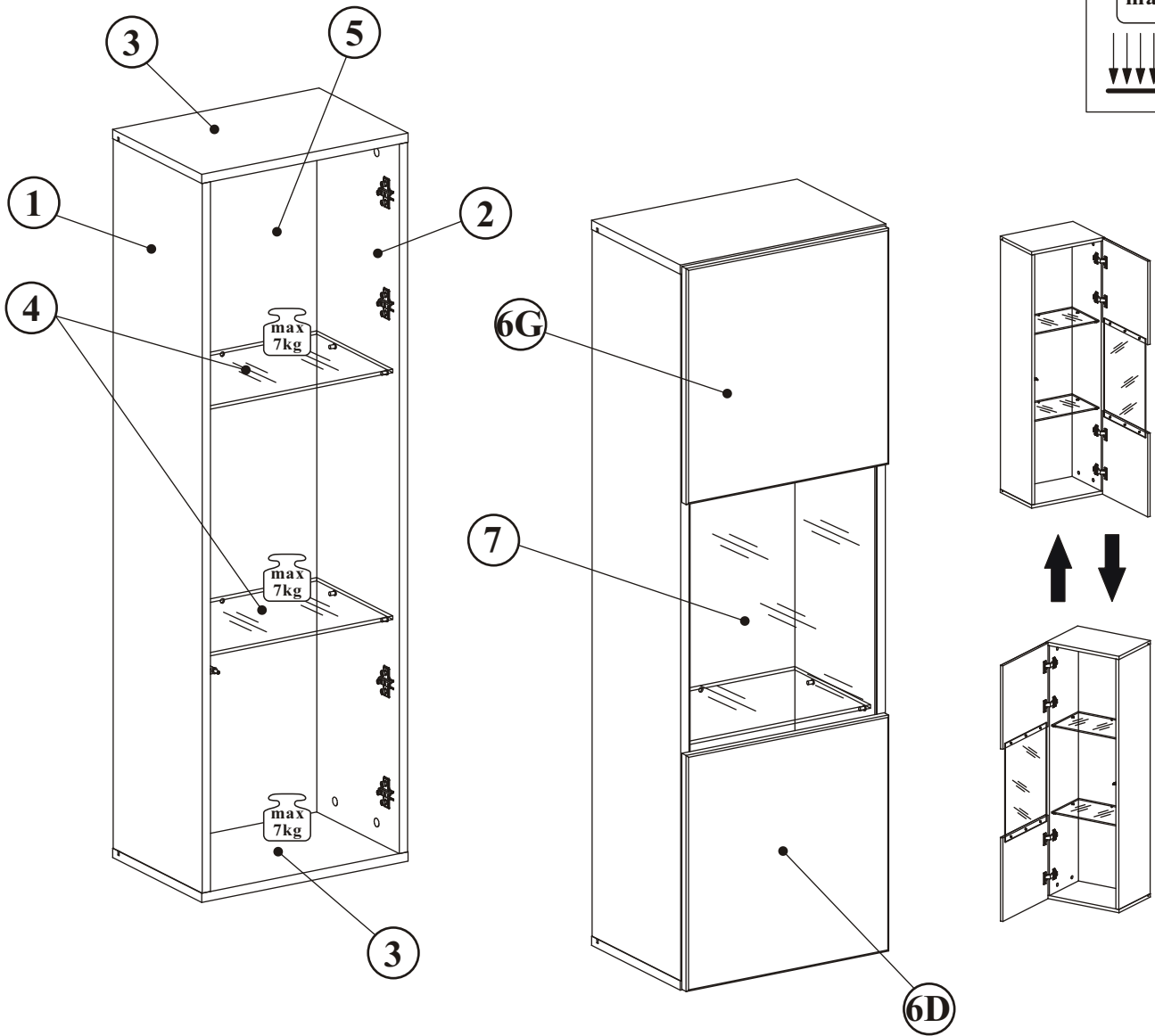

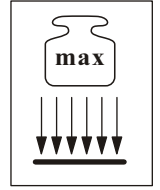

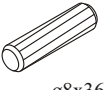

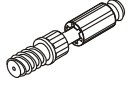

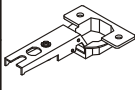
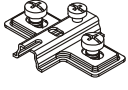
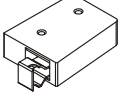
# FLY TYP-22

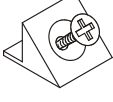

NO	Dim.			Col.-No	Qty
1	1228	274	16	1	1
2	1228	274	16	1	1
3	400	274	16	1	2
4	364	234	6	1	2
5	1240	378	3	1	1
6G	394	410	16	1	1
6D	394	410	16	1	1
7	485	362	4	1	1

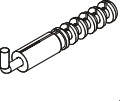
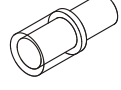
# FLY TYP-22

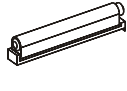
A1 x8  ø8x36	B4 x8 	B5 x8  ø15x12	G5 x8 	E1 x4  Ø26 H=0	E2 x4  H=0
ZR1 x2 	D6 x4  USØ3,5x30	S1 x10 	D10 x10  USØ3,5x13	UP13 x6  UPØ3x16	P2 x6 
KR2 x2 	G20 x8 	G2 x1 	Z2 x8  ø5	T1 x1 	

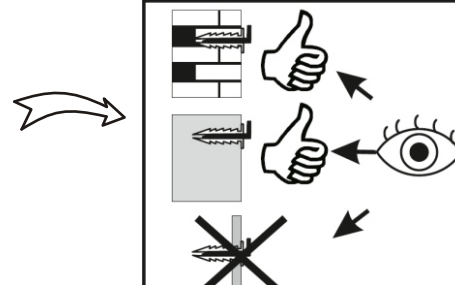
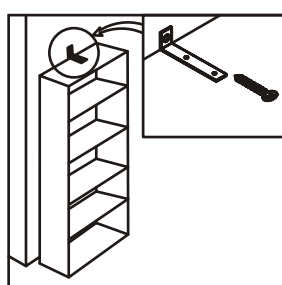
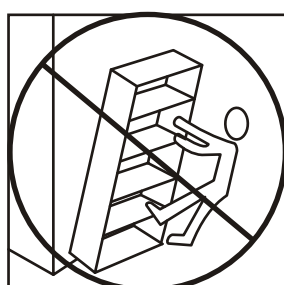
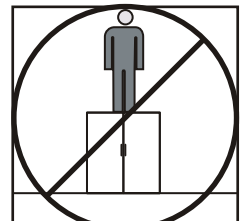
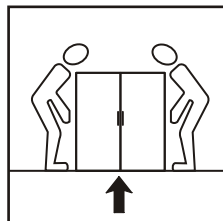
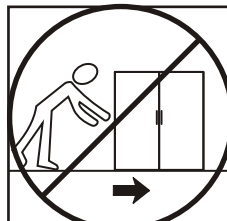
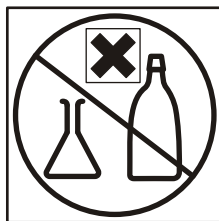
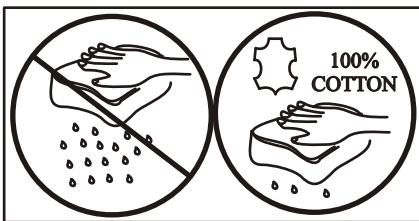
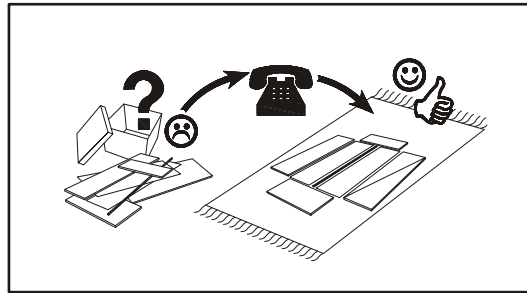
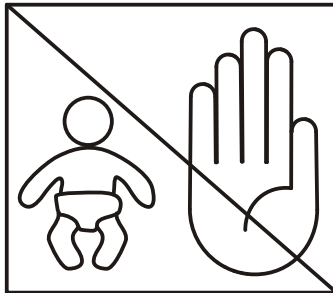
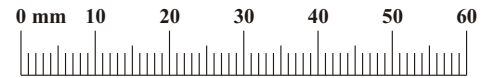

# FLY TYP-22

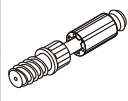
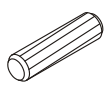
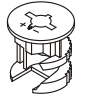
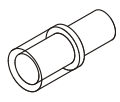
B4		A1		B5	
x8		x8	ø8x36	x8	ø15x12
		G20			
		x8			

1

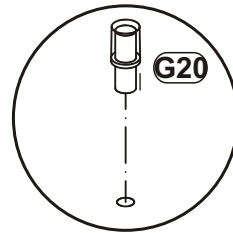
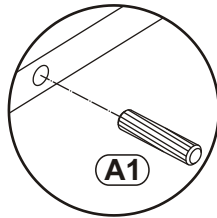
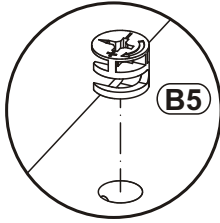
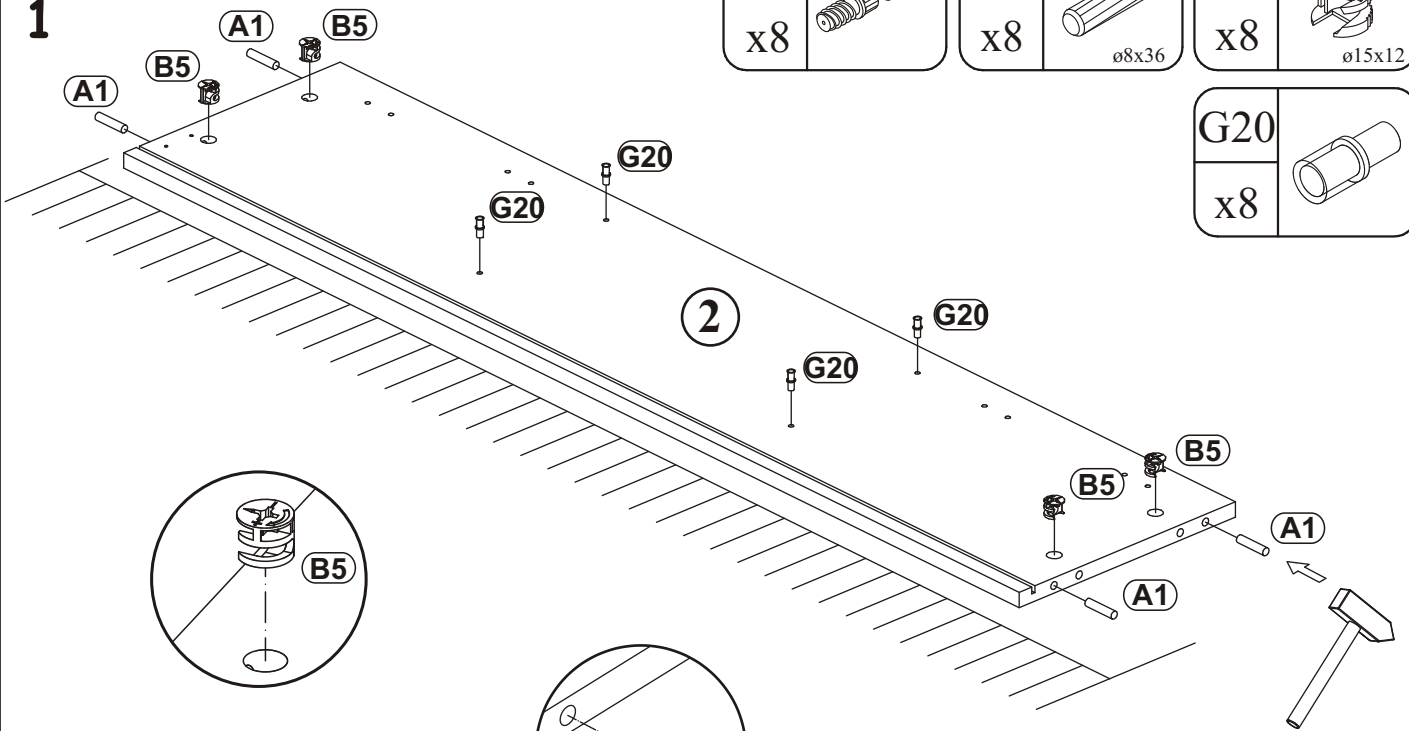

1

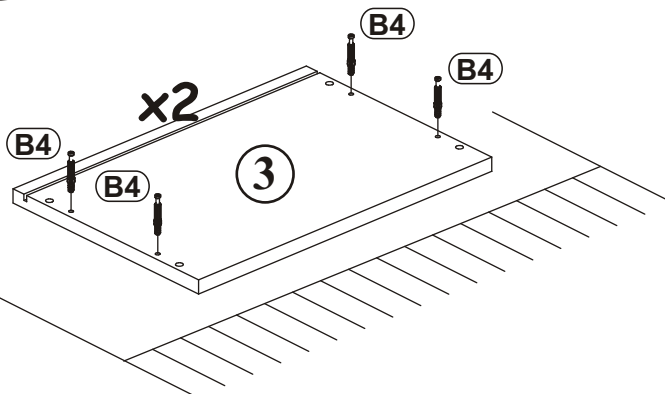
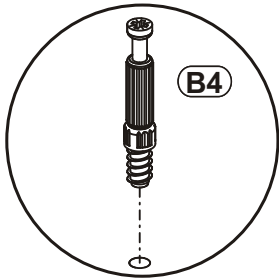
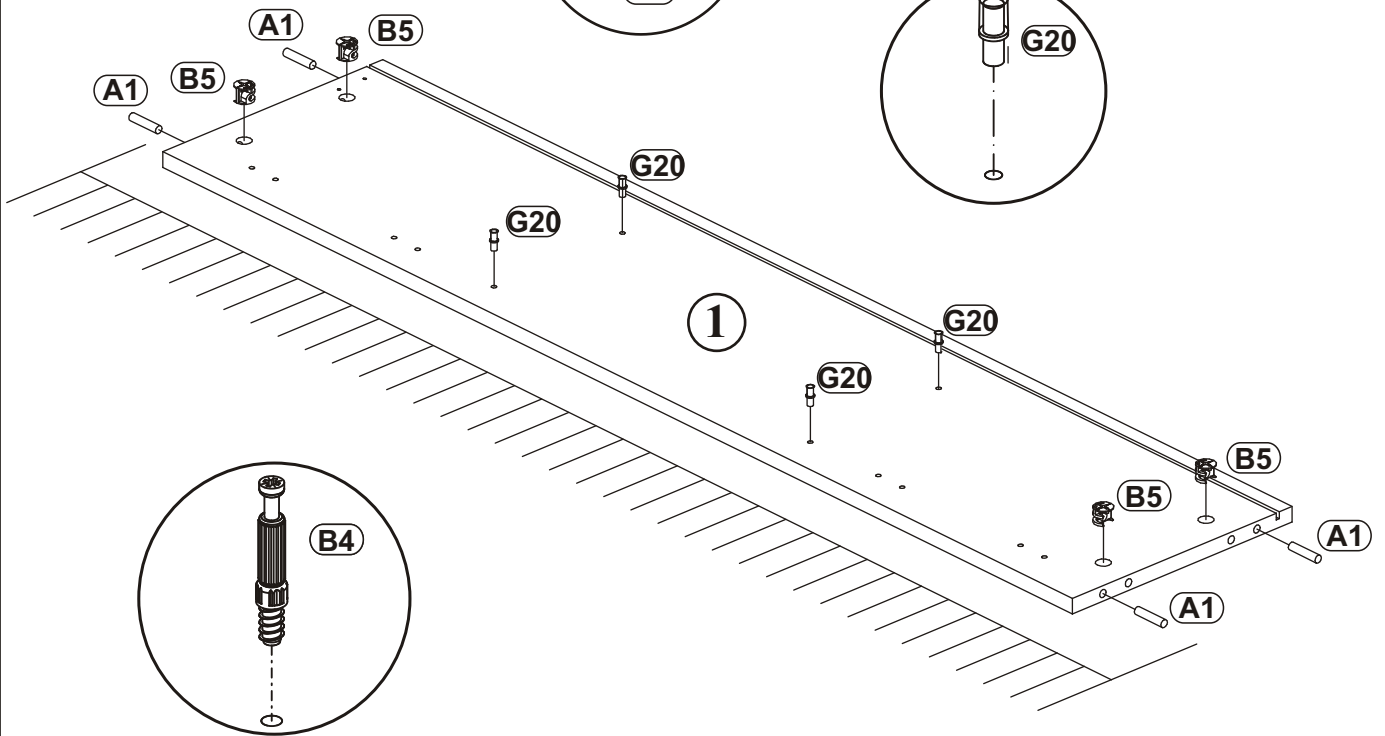

# FLY TYP-22

2

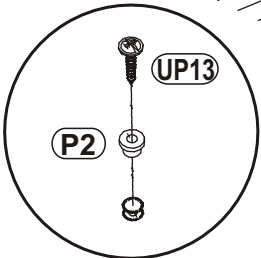
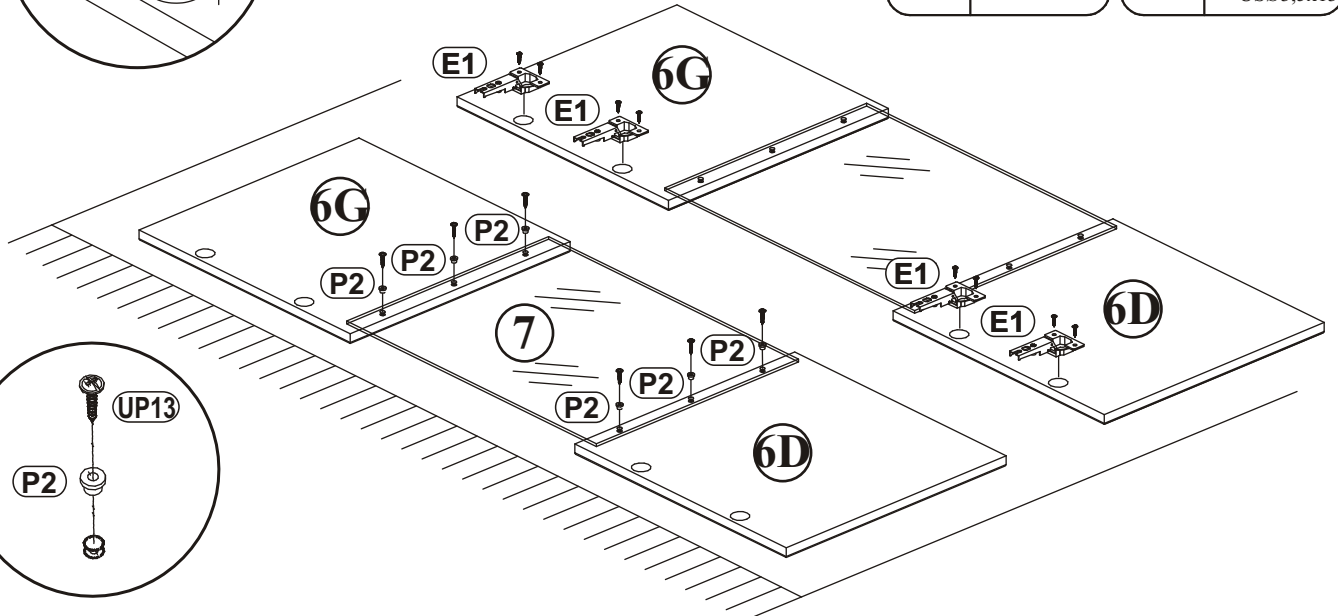
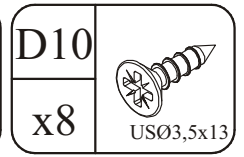
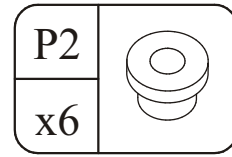
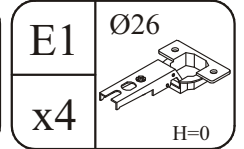
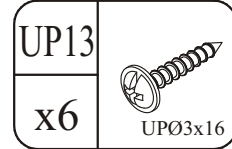
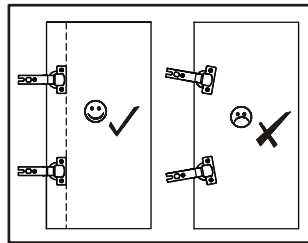
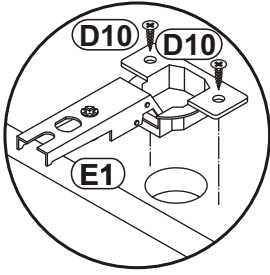

3

a)

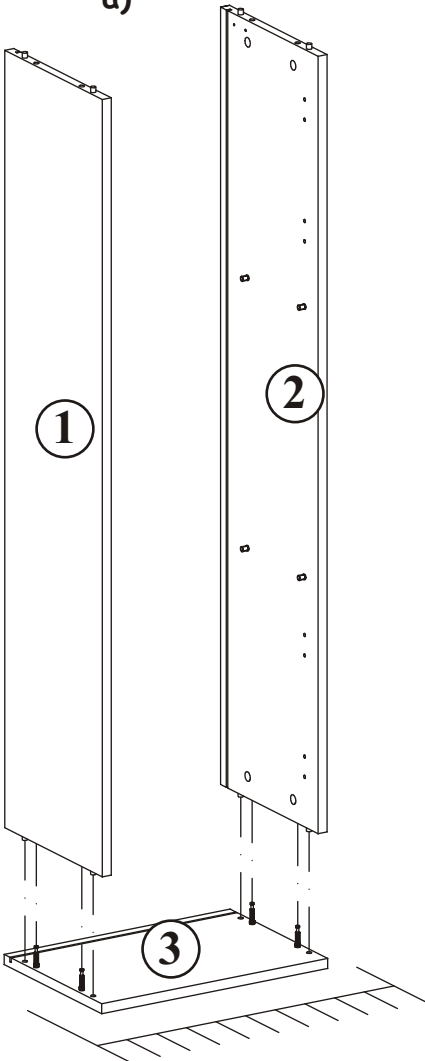

b)

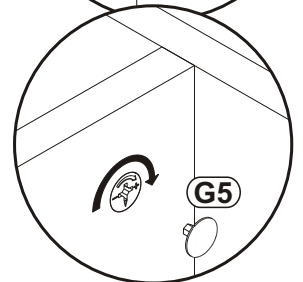
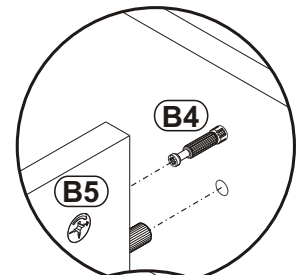
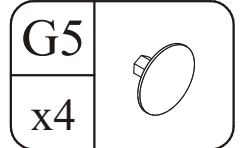
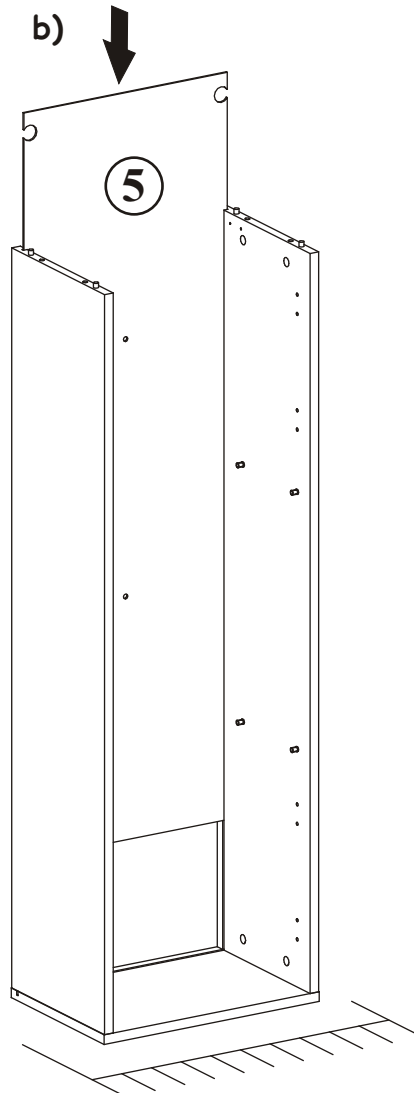

4

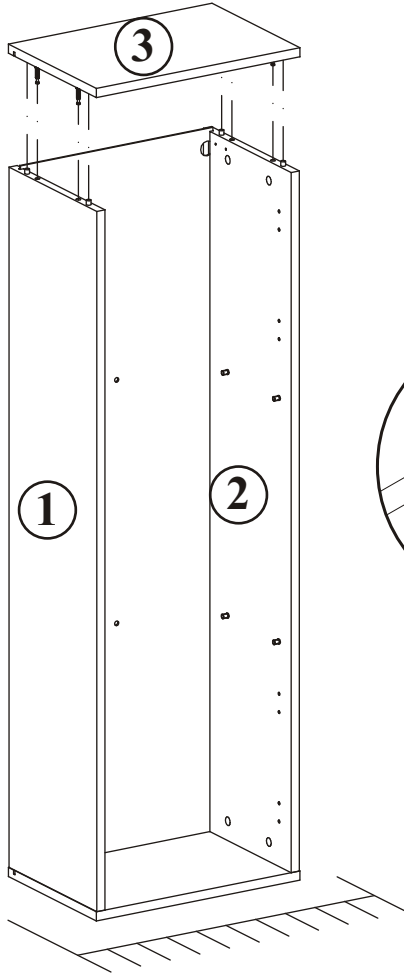

G5	
x4	

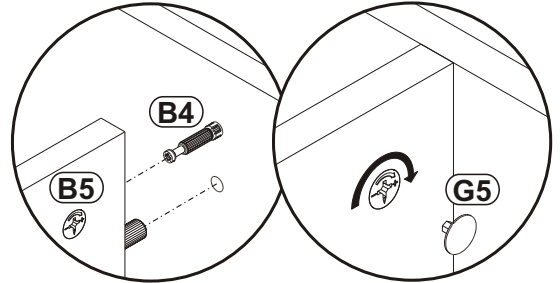

5

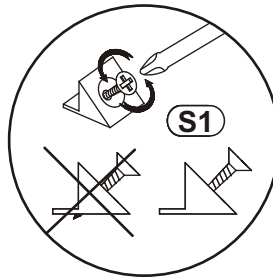
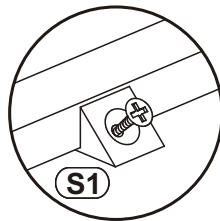

S1	
x10	

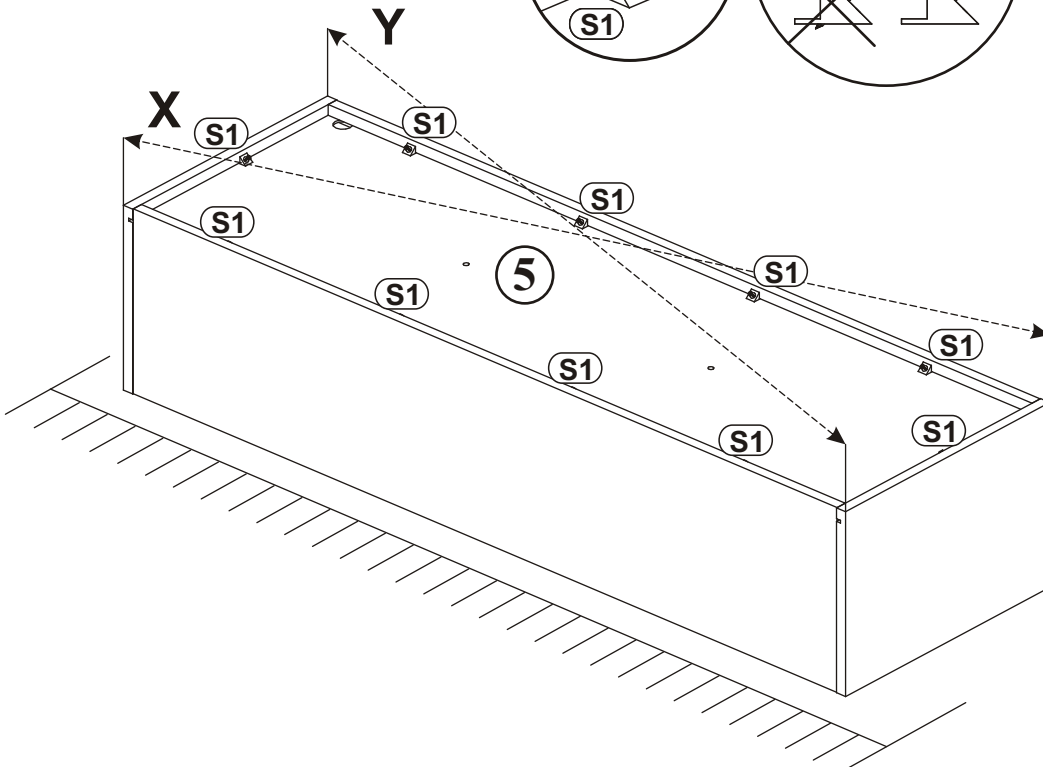

FLY TYP-22

6

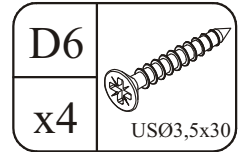
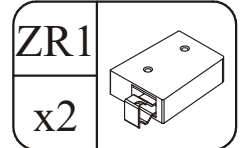
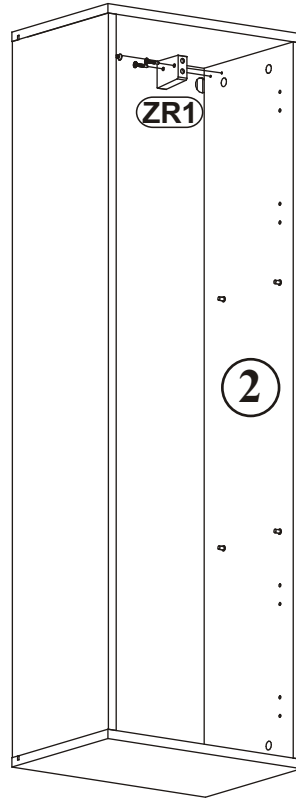
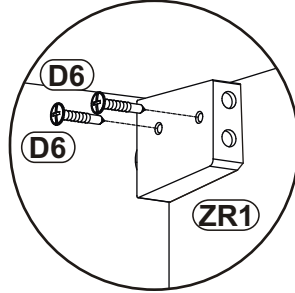
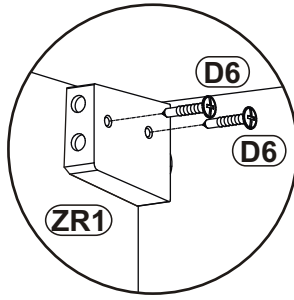
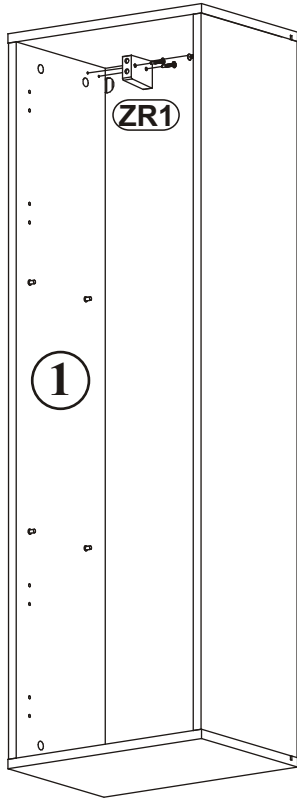

7

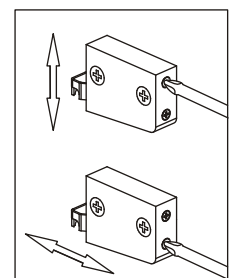
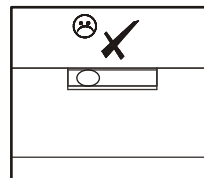
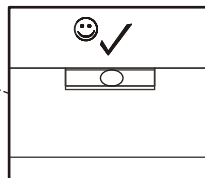
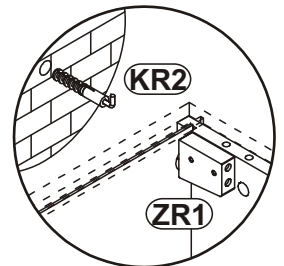
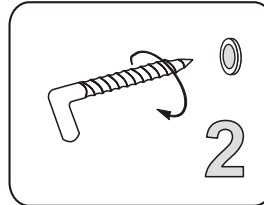
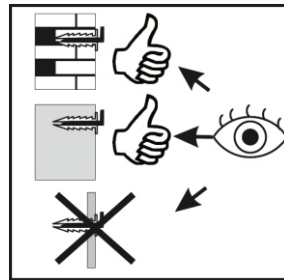
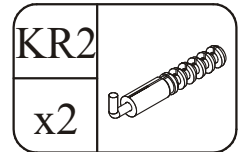
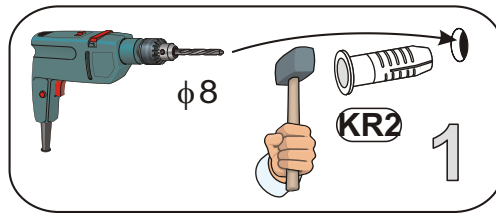
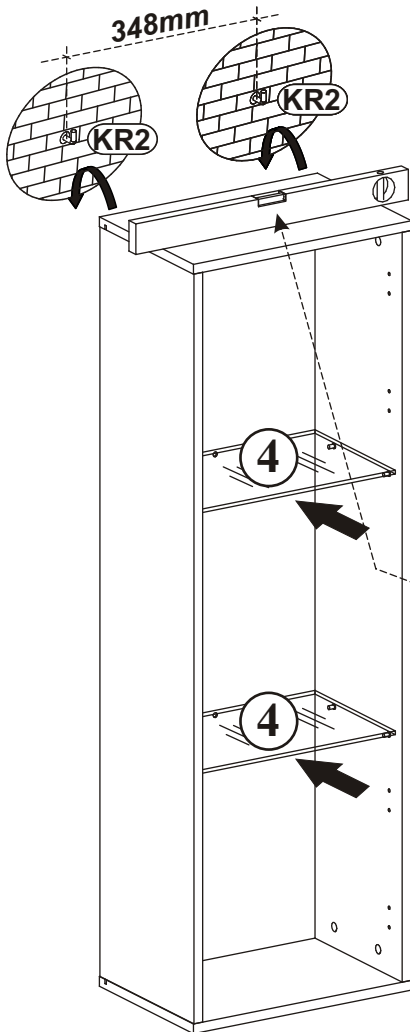

8 - 9

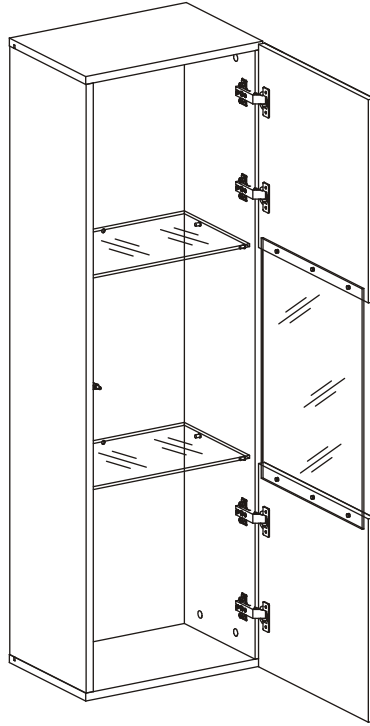

10 - 11

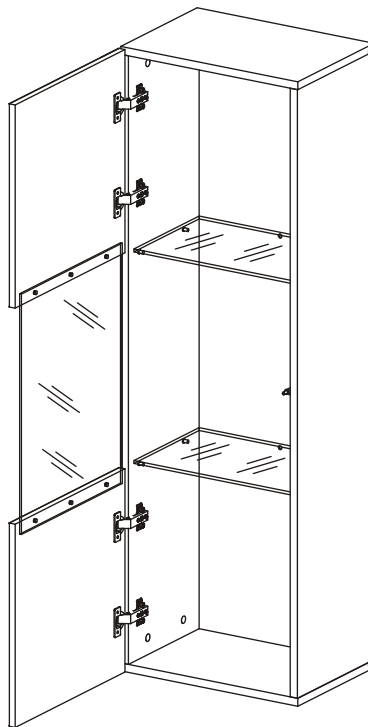

FLY TYP-22

8

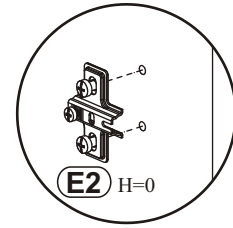
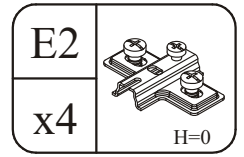
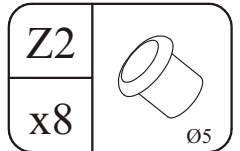
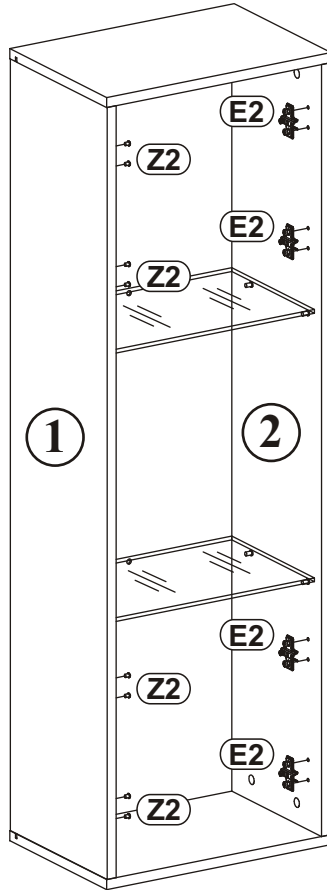
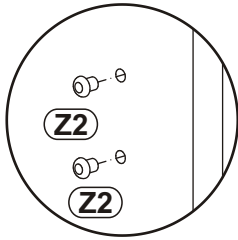
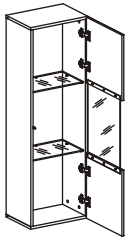

9

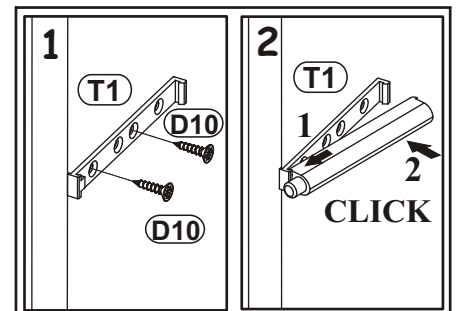
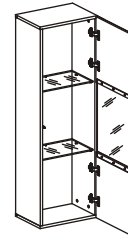
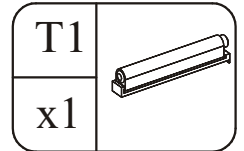
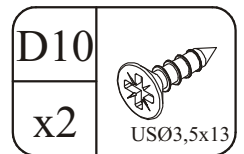
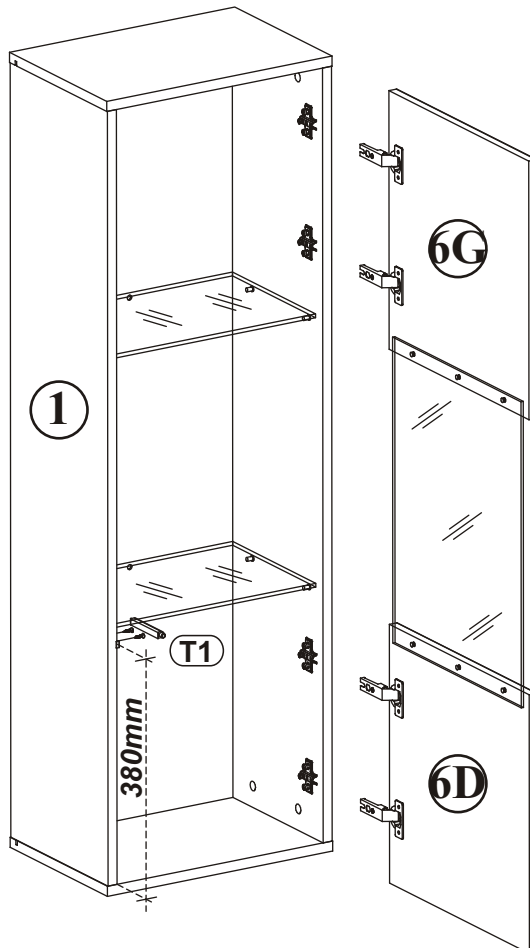
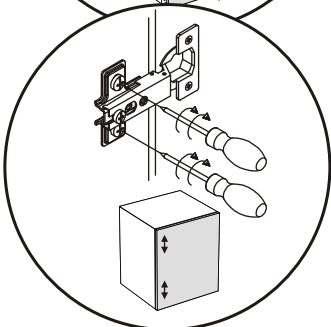
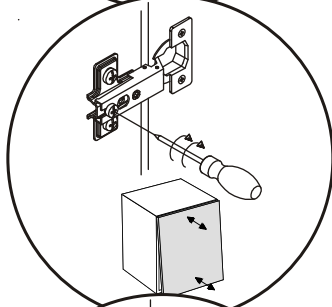
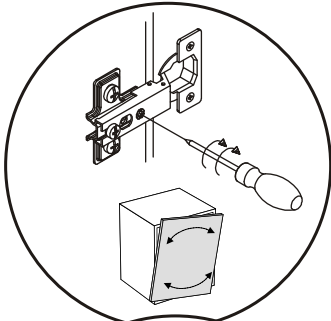



FLY TYP-22

10

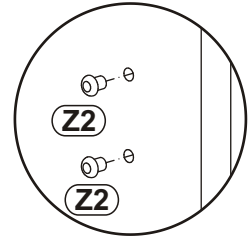
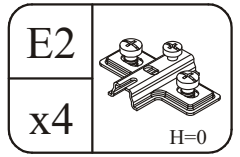
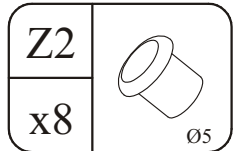
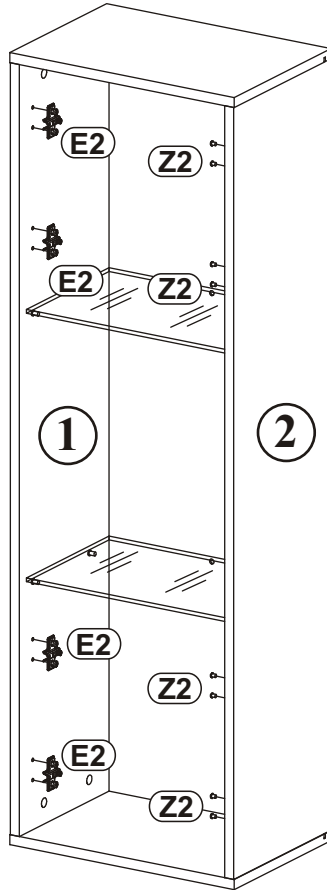
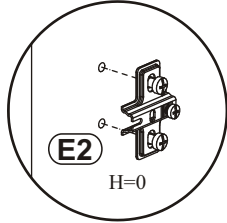
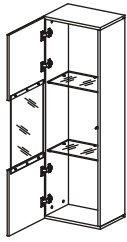

11

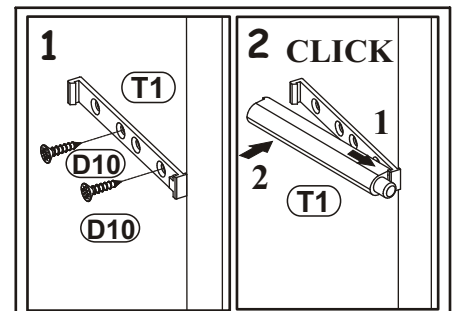
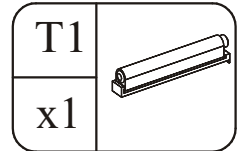
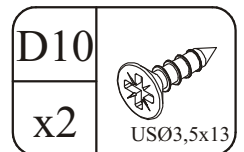
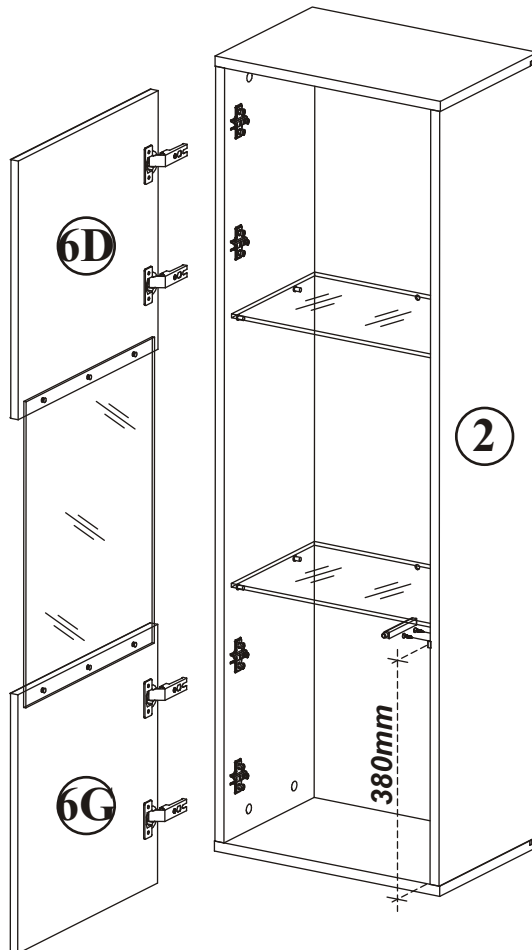
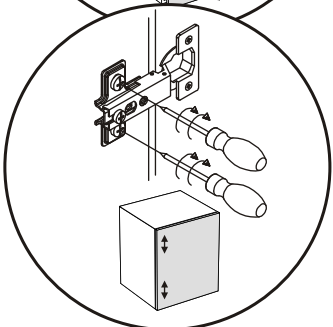
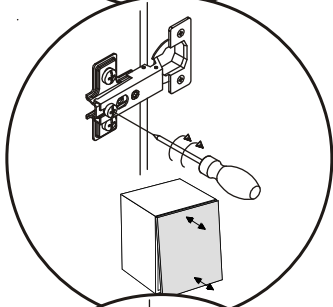
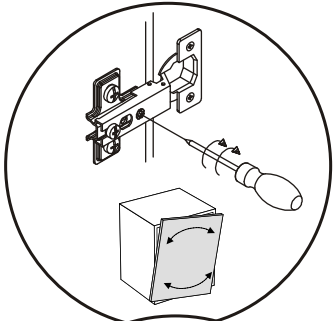



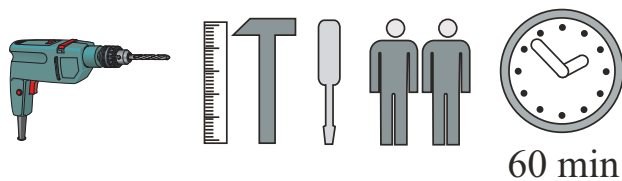
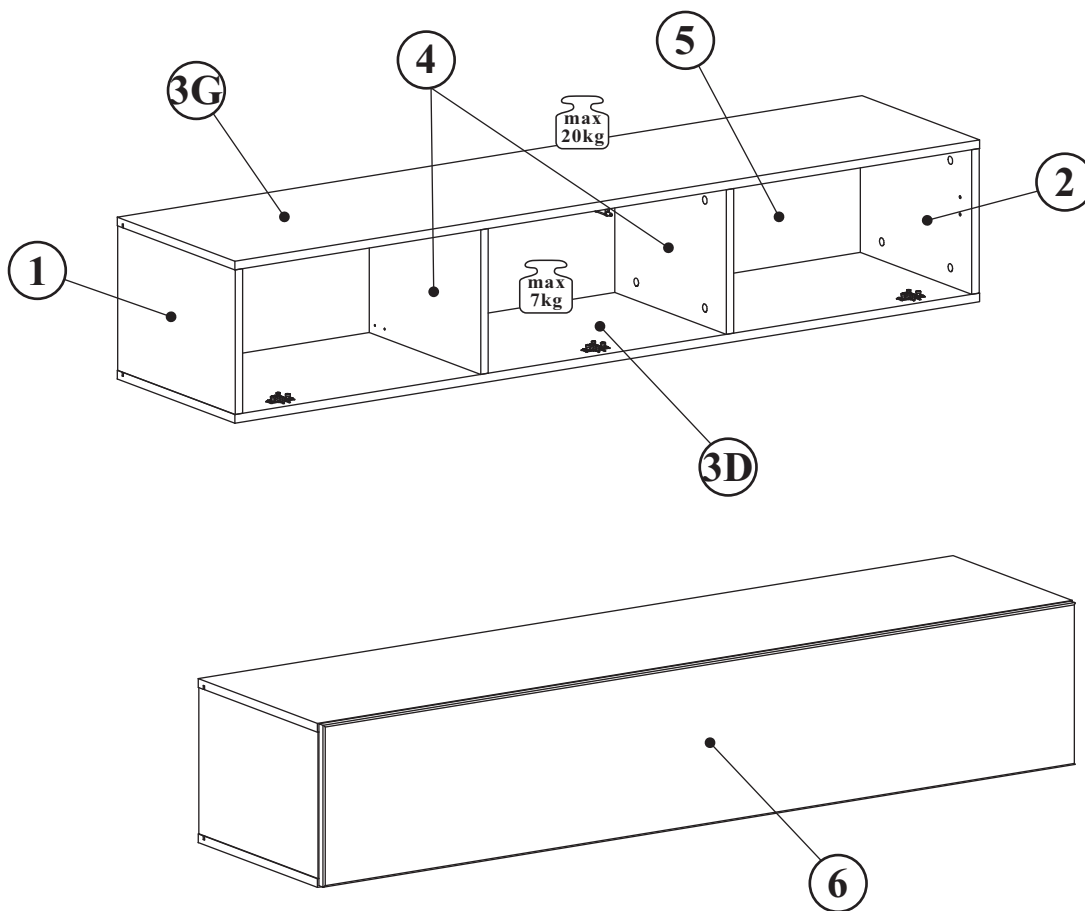
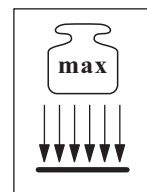





# FLY TYP-30

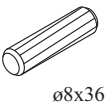
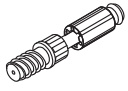

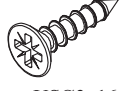
60 min

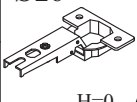
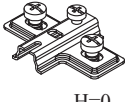
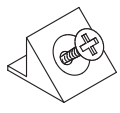
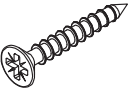
NO	Dim.			Col.-No	Qty
1	268	384	16	1	1
2	268	384	16	1	1
3D/G	1602	384	16	1	2
4	268	364	16	1	2
5	1580	280	3	1	1
6	1596	296	16	1	1

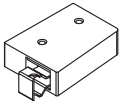
# FLY TYP-30

A1 x16  ø8x36	B4 x16 	B5 x16  ø15x12	G5 x16 	D7 x6  USØ3x16	G2 x1 
E1 x3 Ø26 H=0 	E2 x3 H=0 	S1 x12 	D6 x8 USØ3,5x30 	D10 x12 USØ3,5x13 	G21 x2 
ZR1 x4 	KR2 x4 	T1 x1 			

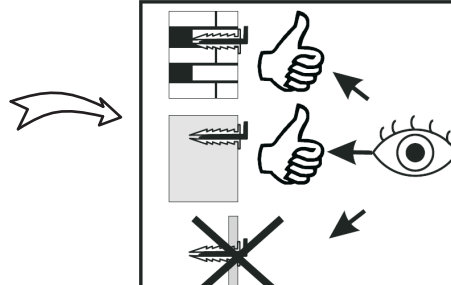
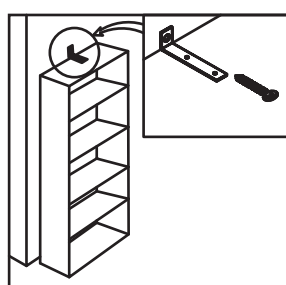
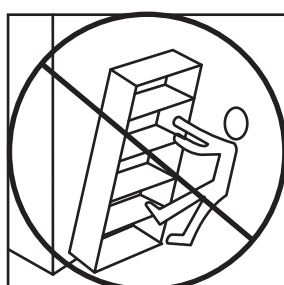
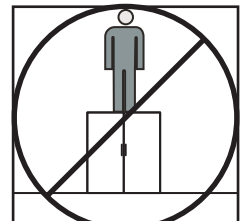
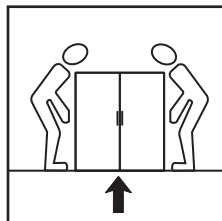
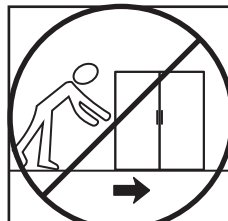
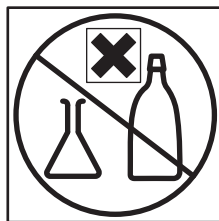
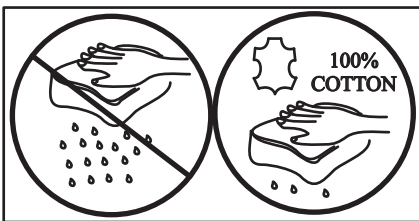
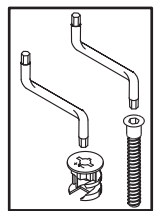
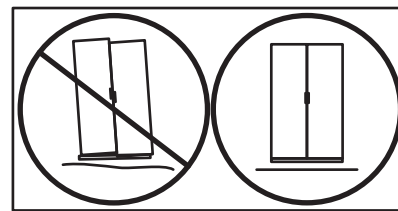
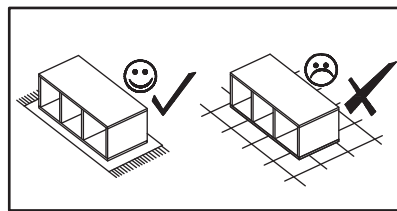
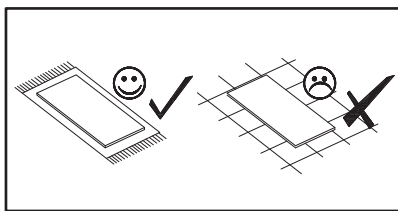
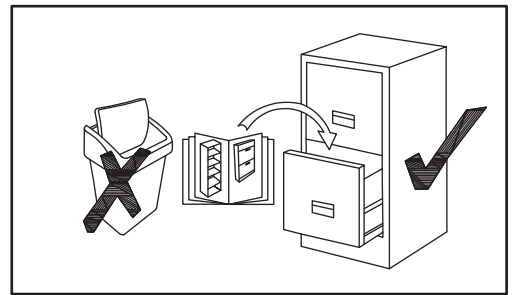
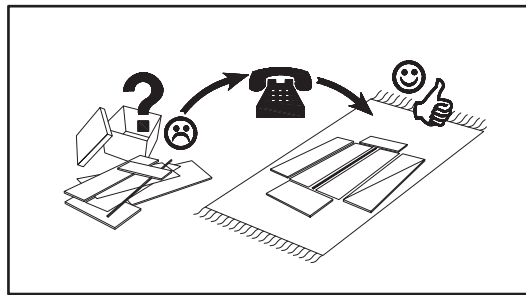
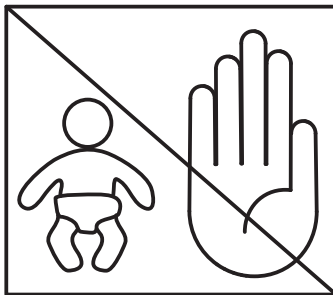
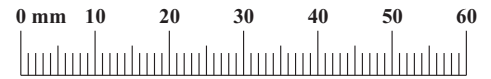

# FLY TYP-30

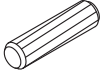
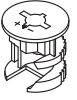
A1		B5	
x16	ø8x36	x16	ø15x12

## 1

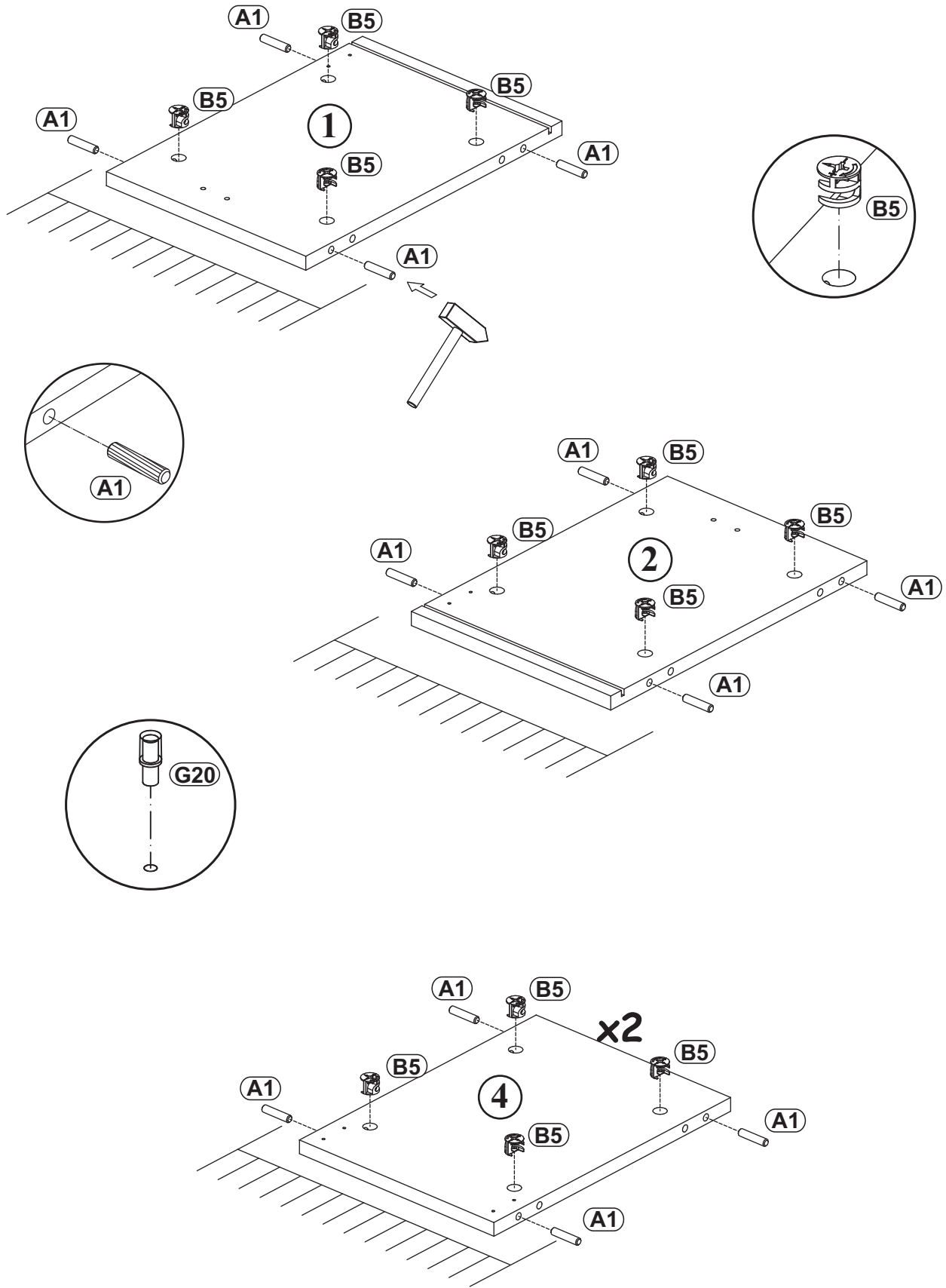

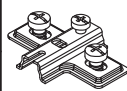
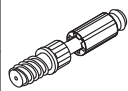

FLY TYP-30

2

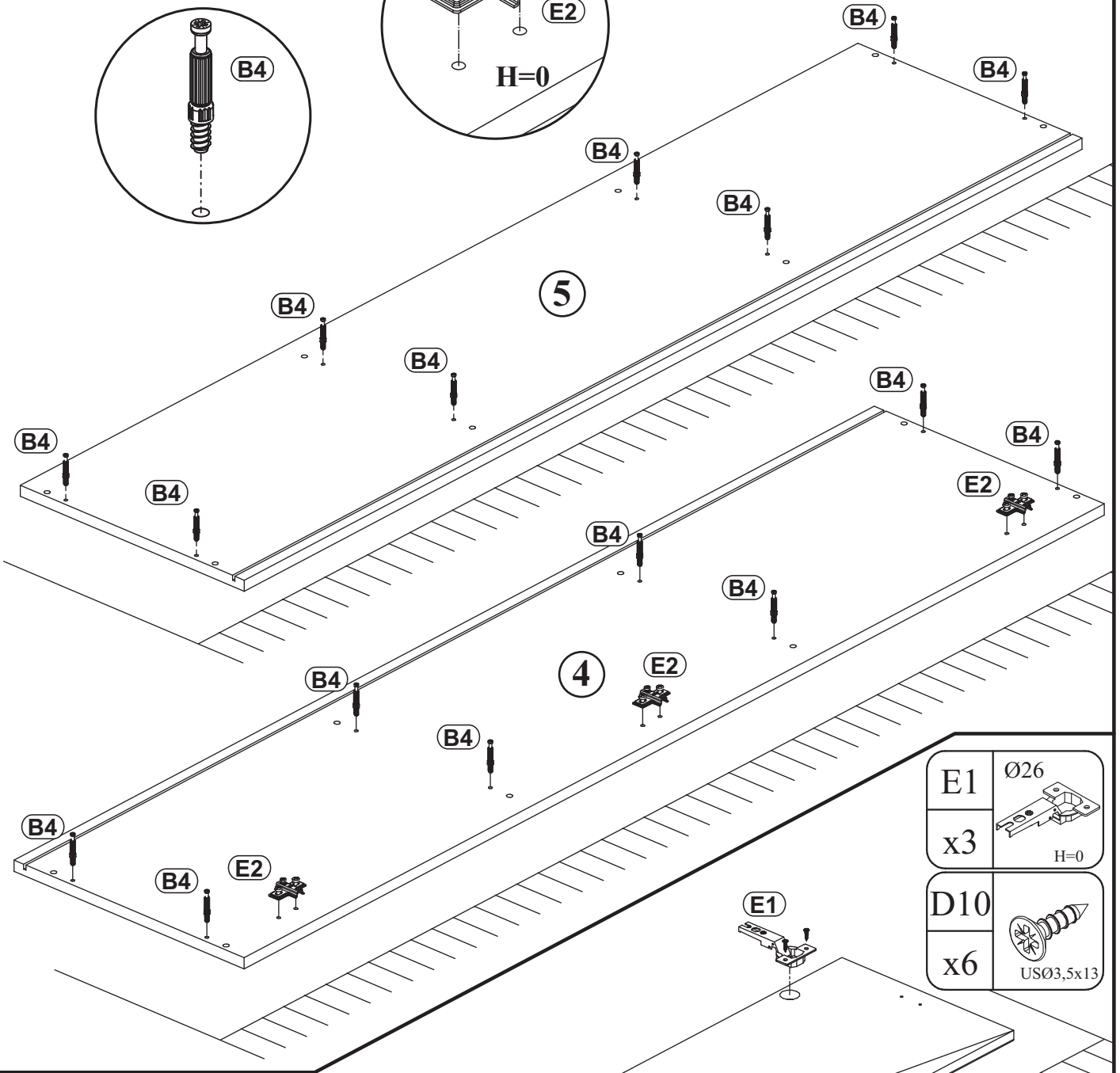
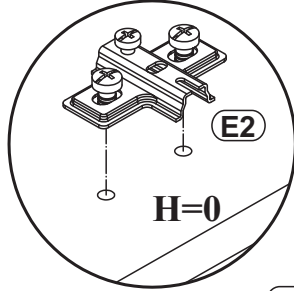
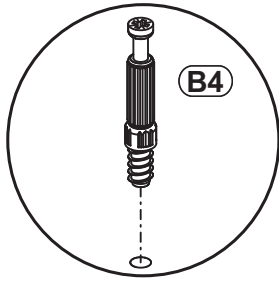
E2		B4	
x3	H=0	x16	

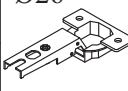

3

E1		Ø26
x3	H=0	
D10		
x6	USØ3,5x13	

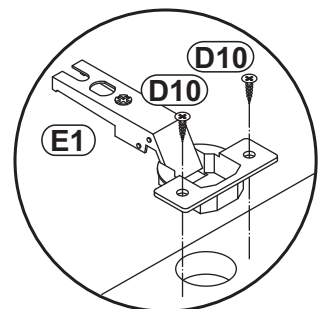
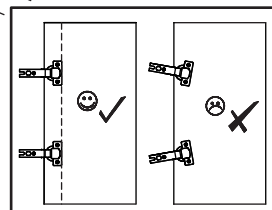
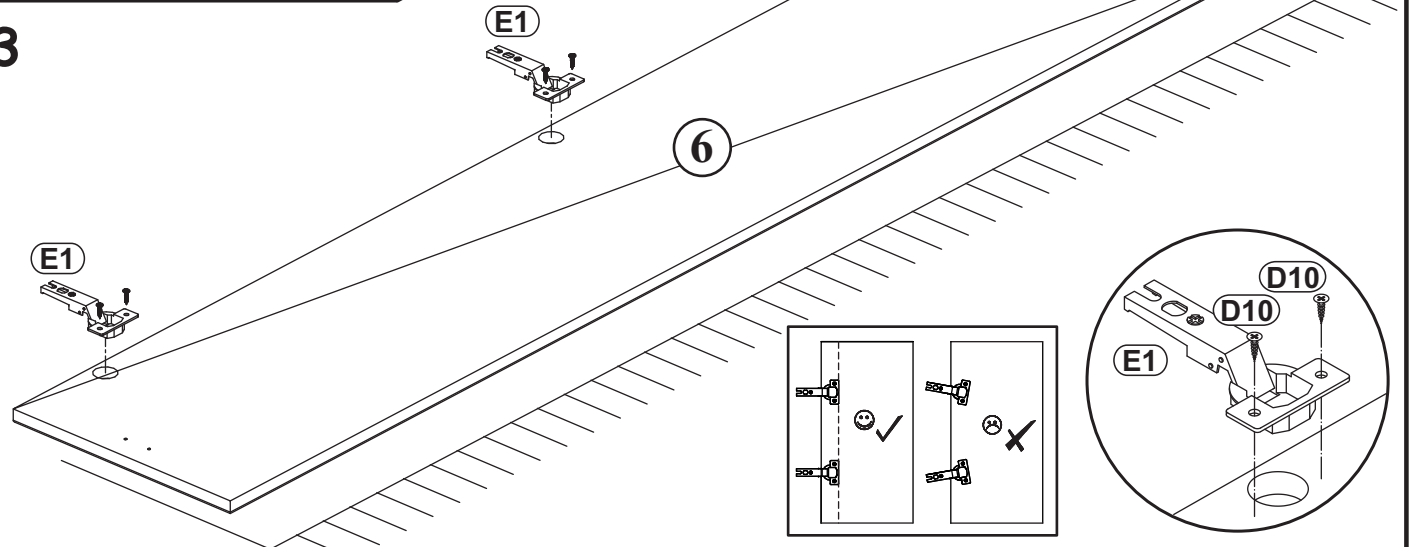

G5	
x16	

4

a)

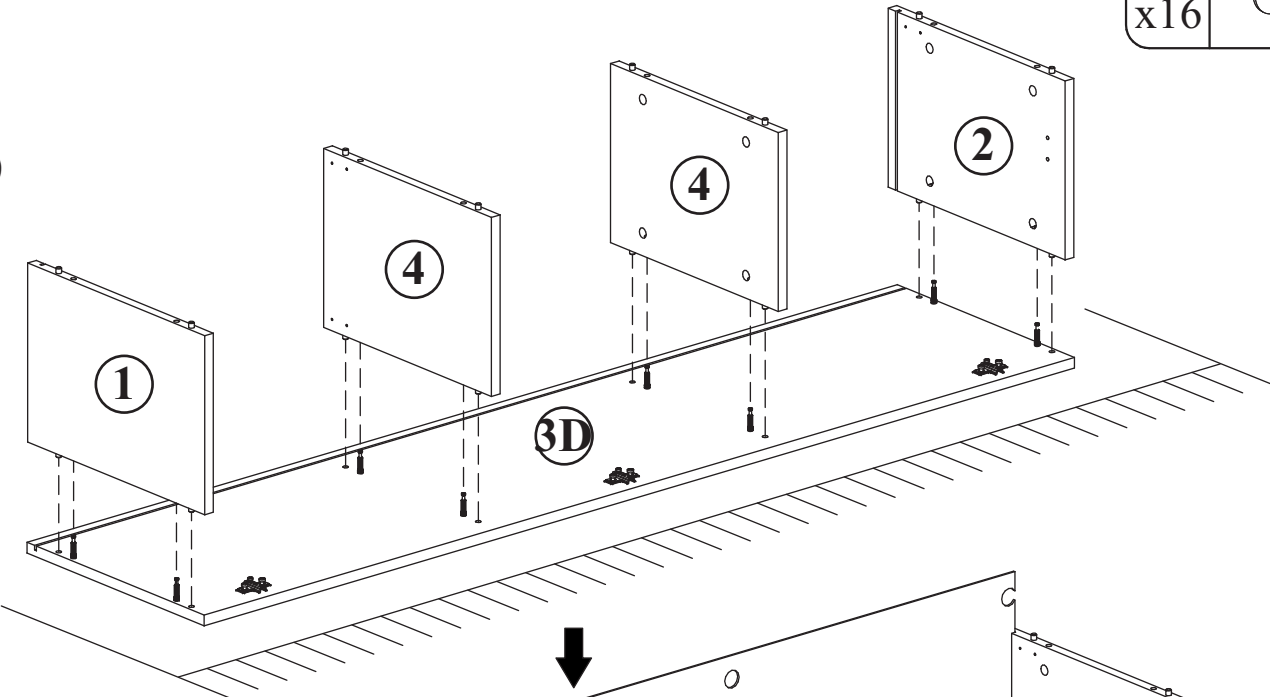

b)

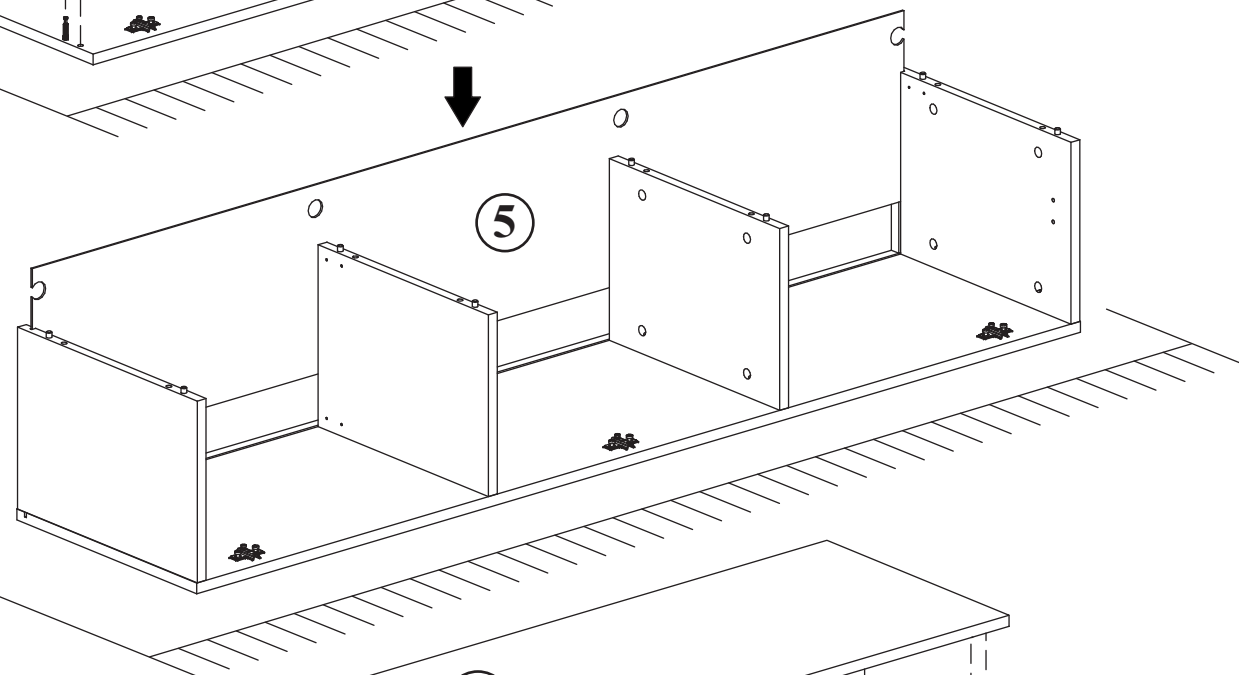

c)

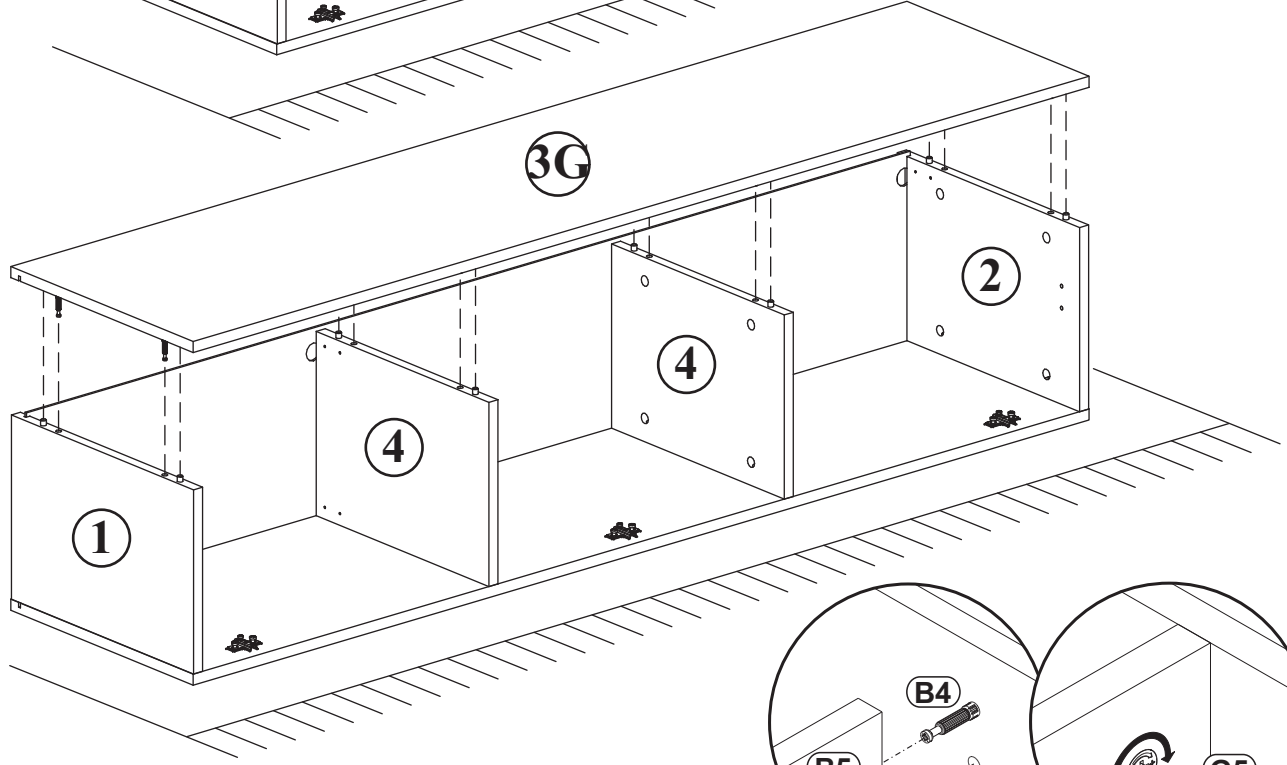

B4

B5

G5

5

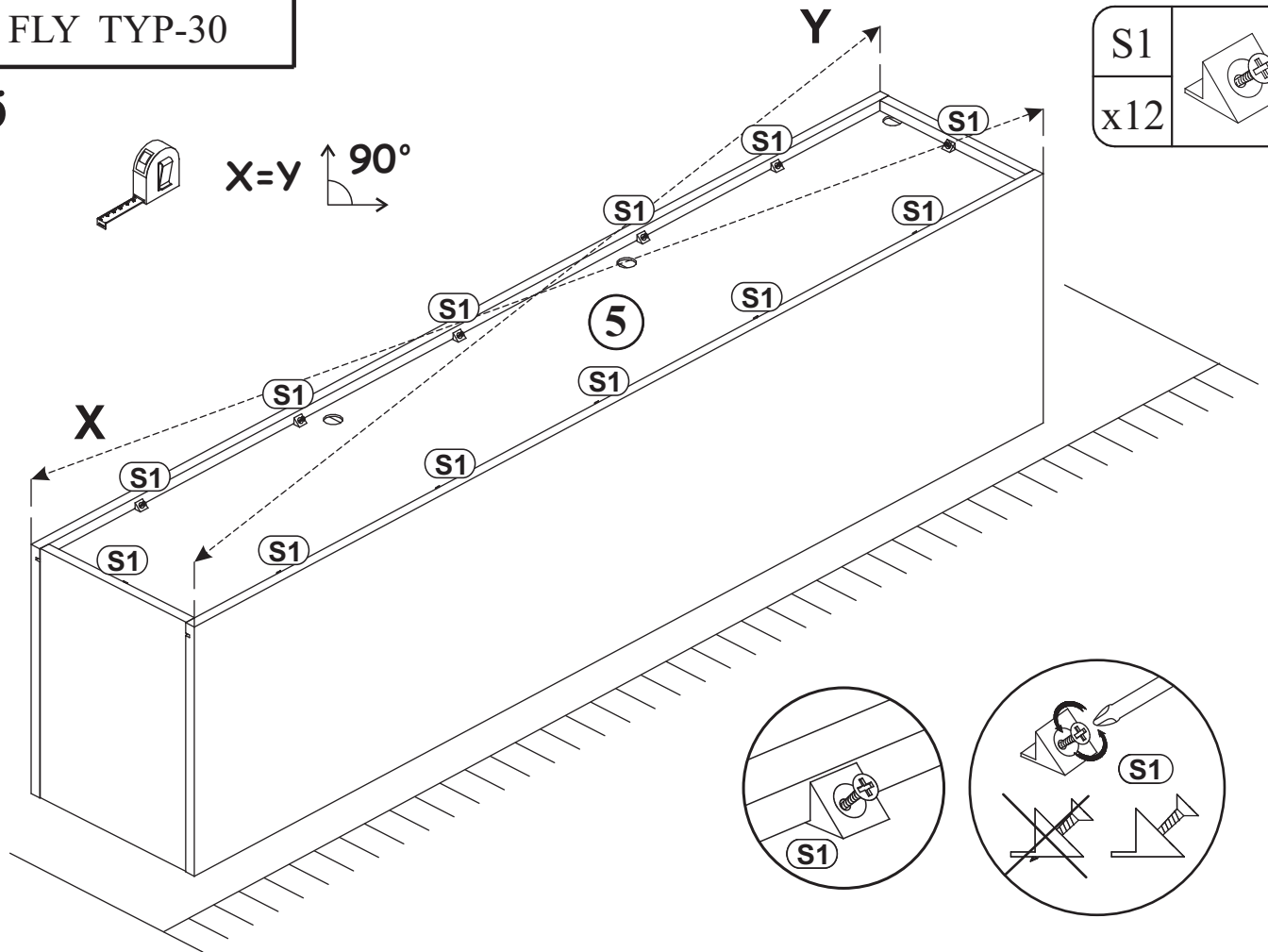

S1	
x12	

6

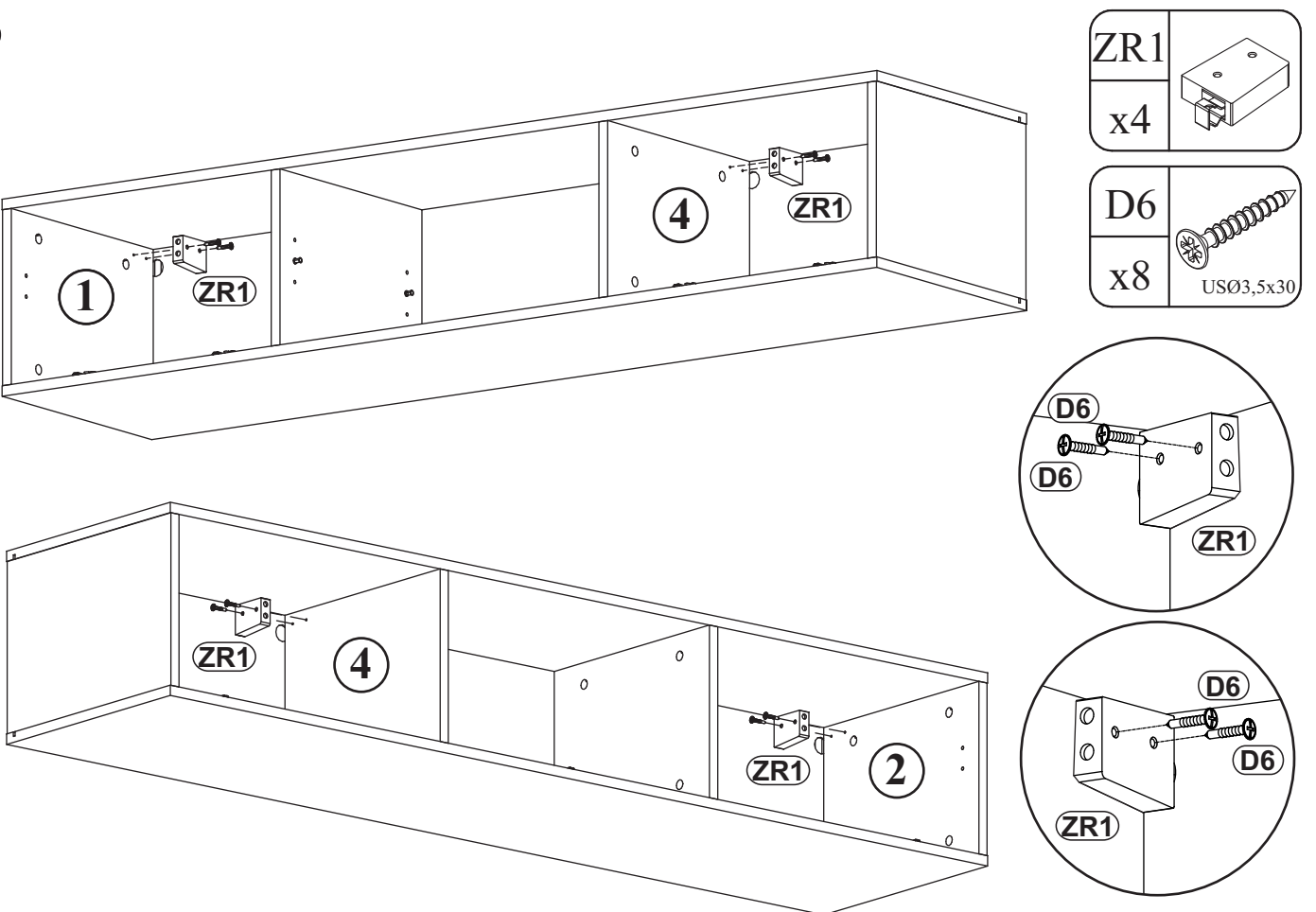

ZR1	
x4	

D6	
x8	USØ3,5x30

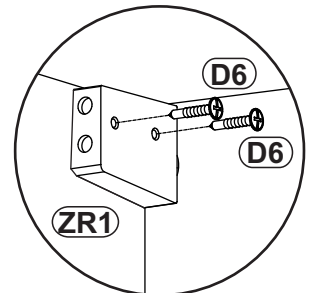
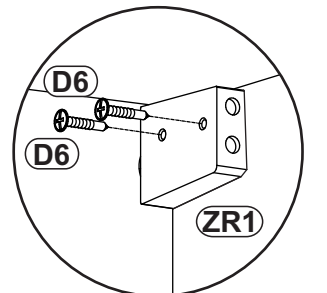

# FLY TYP-30

7

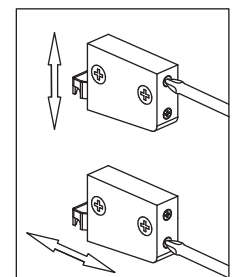
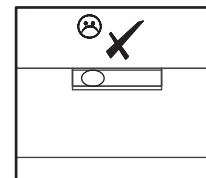
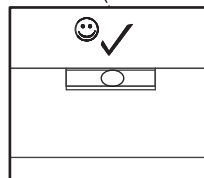
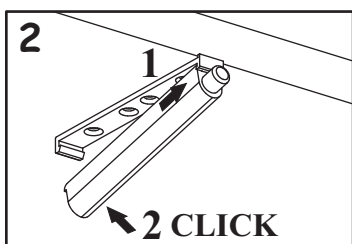
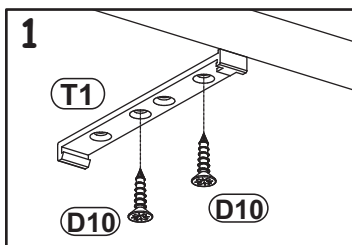
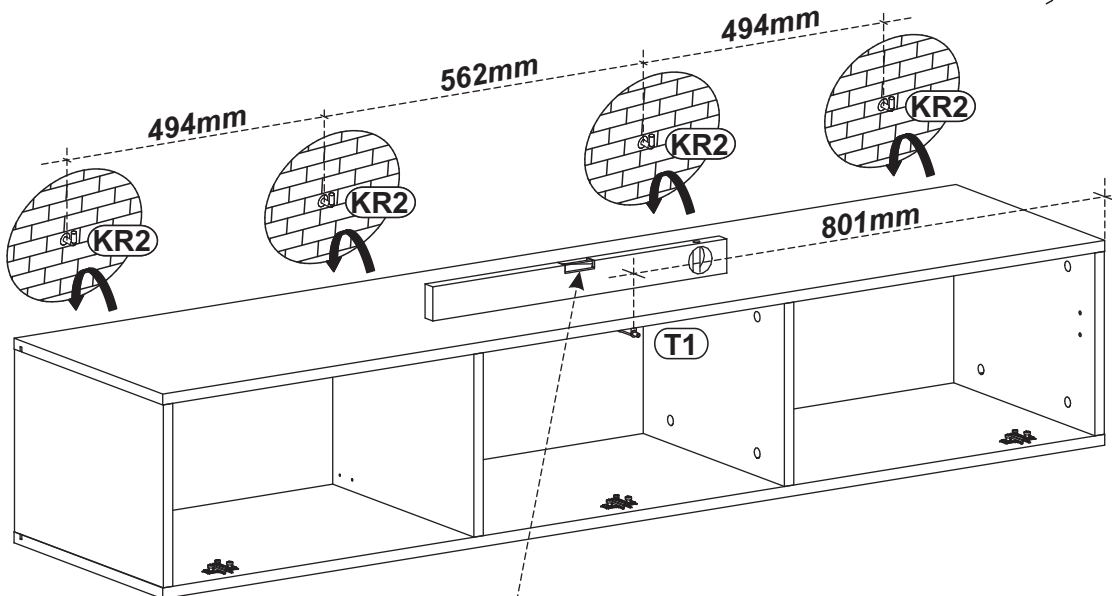
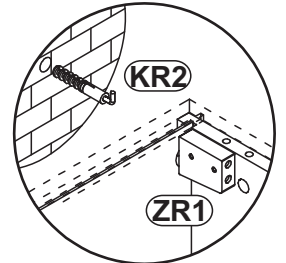
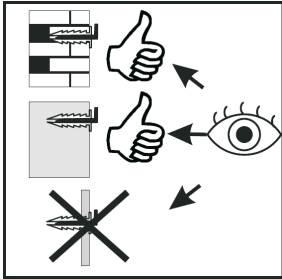
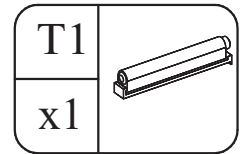
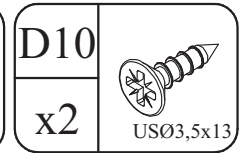
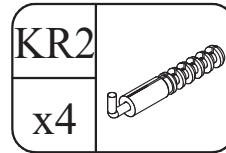
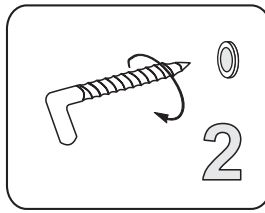
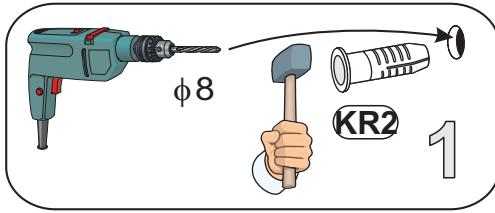



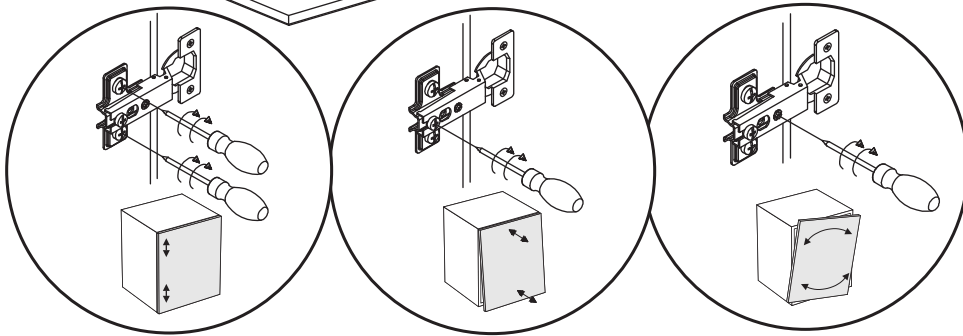
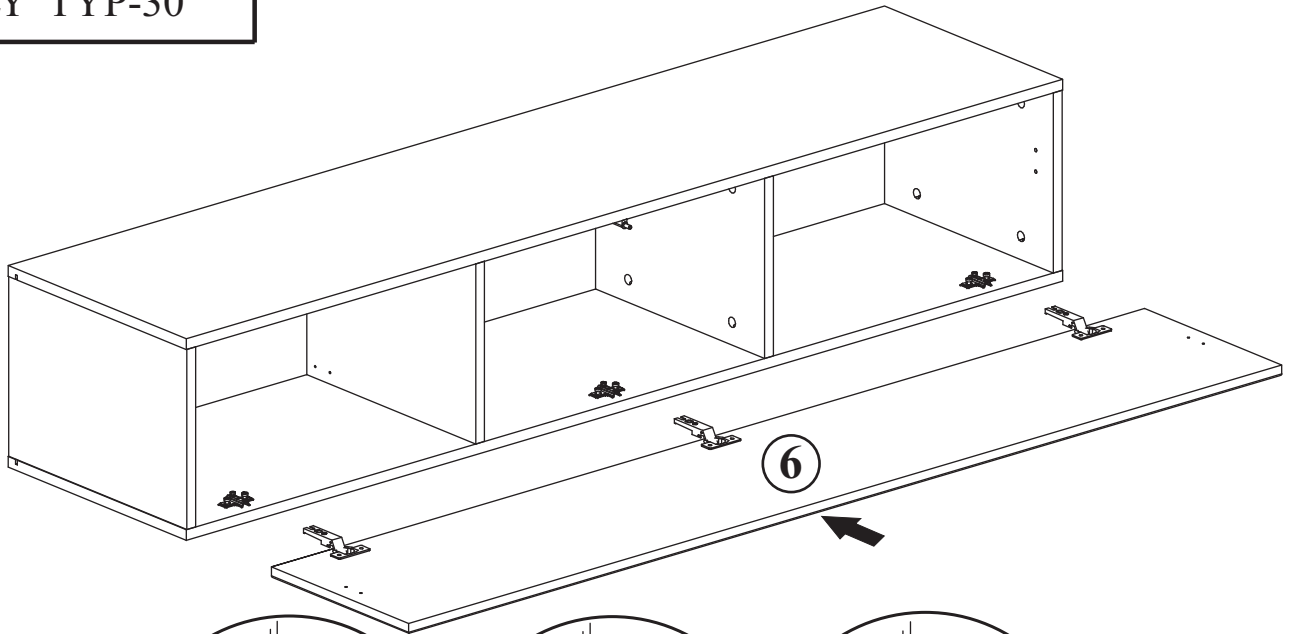

8



9

- |           |  |           |  |
|-----------|--|-----------|--|
| D10<br>x4 | <br>USØ3,5x13 | G21<br>x2 |             |
|           |  | D7<br>x6  | <br>USØ3x16 |

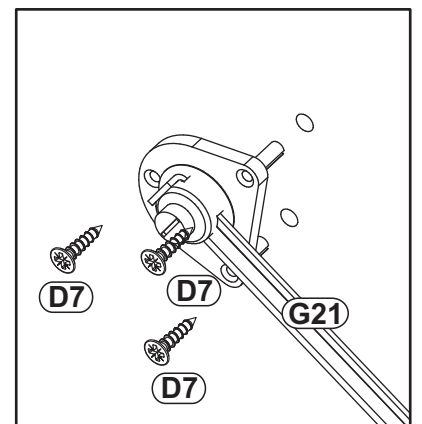
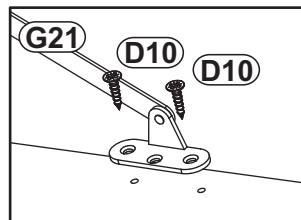
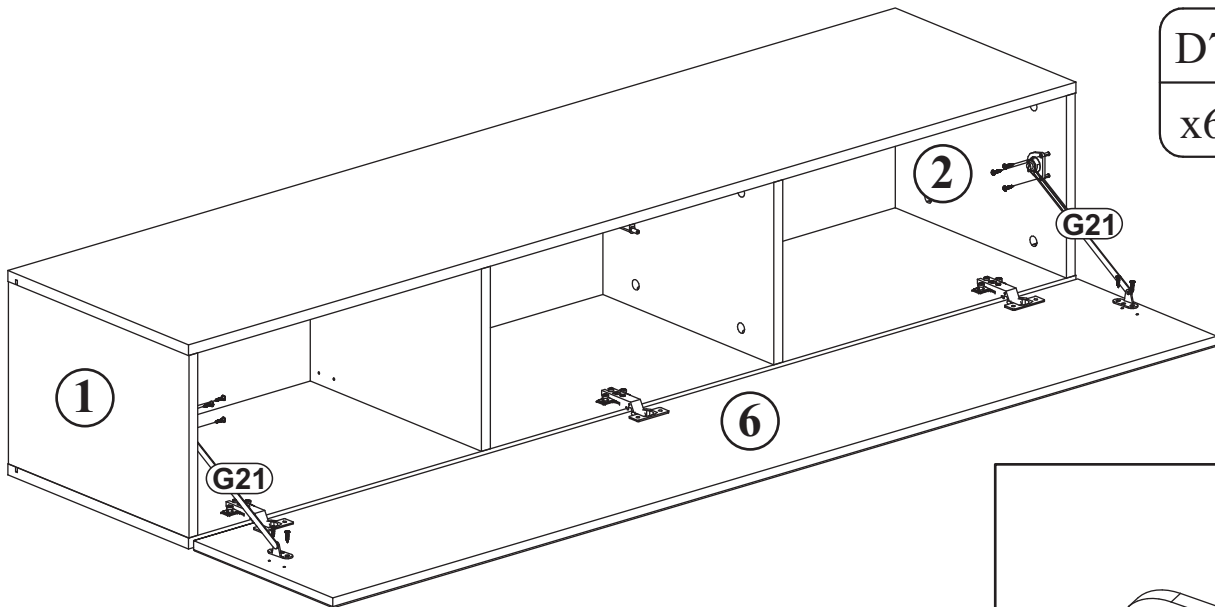



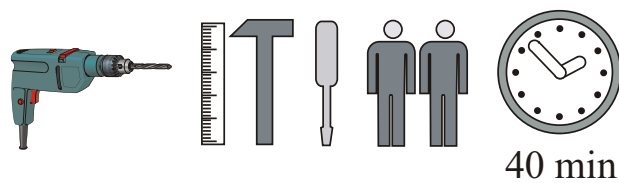
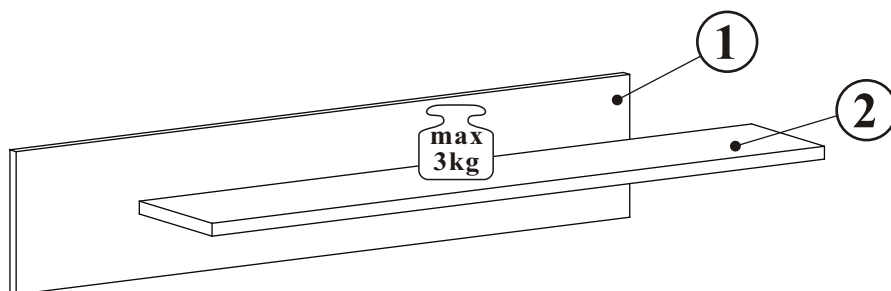
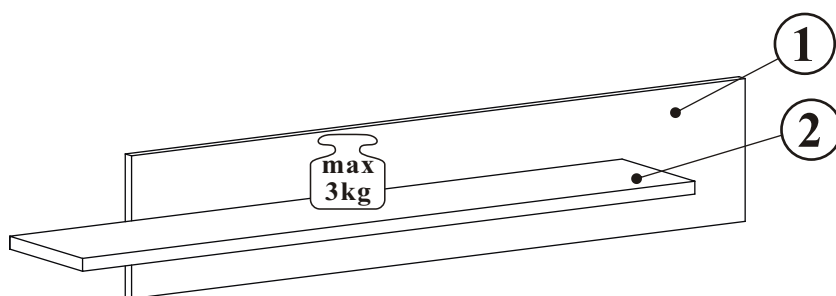
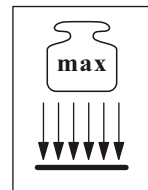
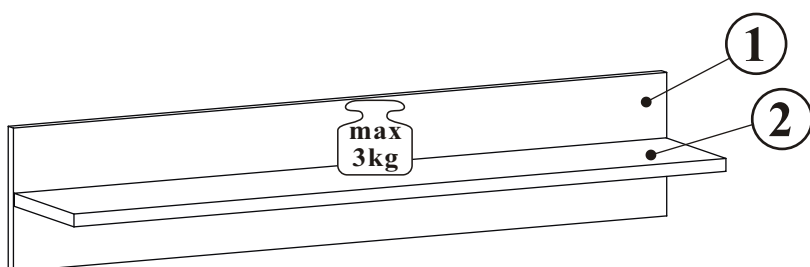



# GALINO 23\_MX

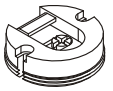

NO	Dim.		Col.-No	Qty
1	1002	200	1	2
2	1000	185	1	2

# GALINO 23\_MX

ZM1 x4		D20 x8	 ESØ6x9,5	B11 x12	 Ø7x50	G4 x12		KR2 x4		G2 x1	
-----------	---	-----------	---	------------	--	-----------	---	-----------	---	----------	---

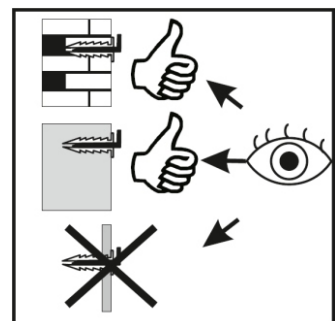
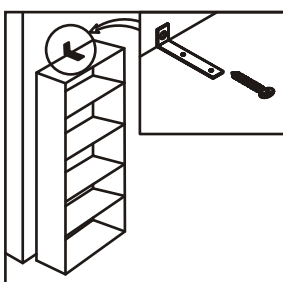
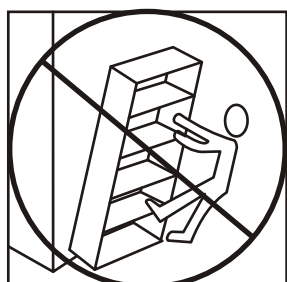
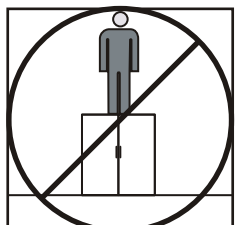
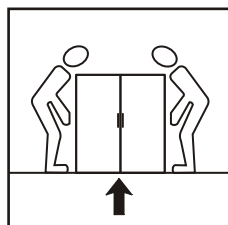
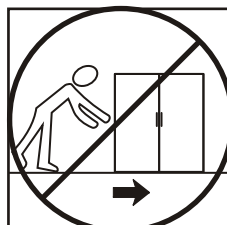
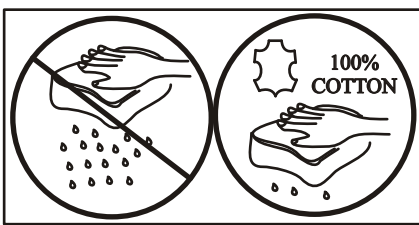
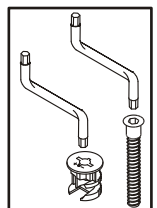
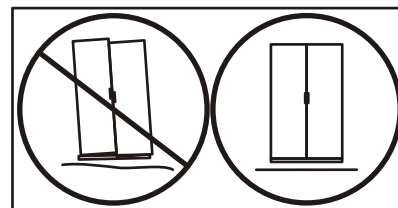
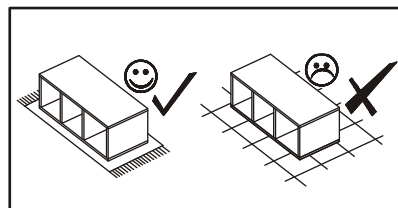
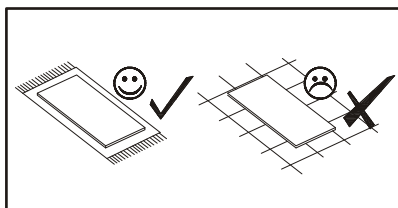
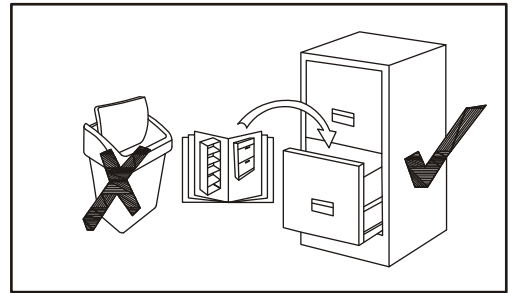
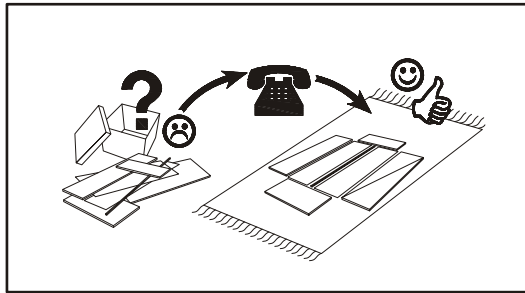
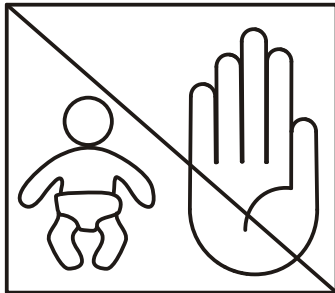
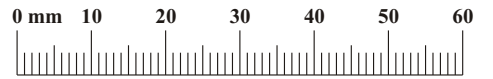

**1-3**

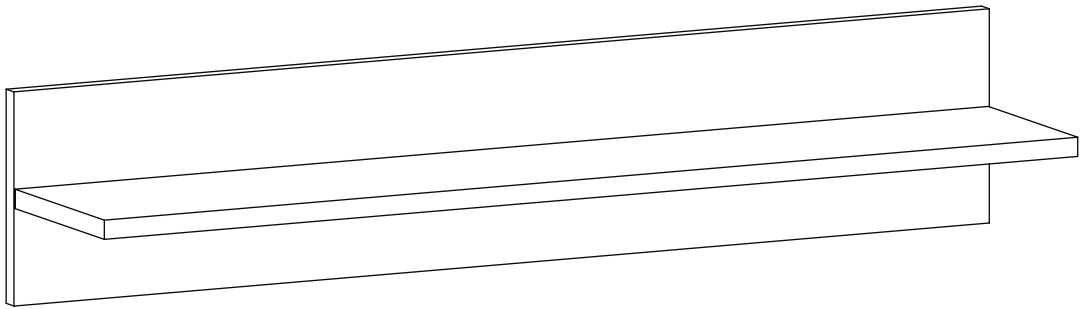

**4-6**

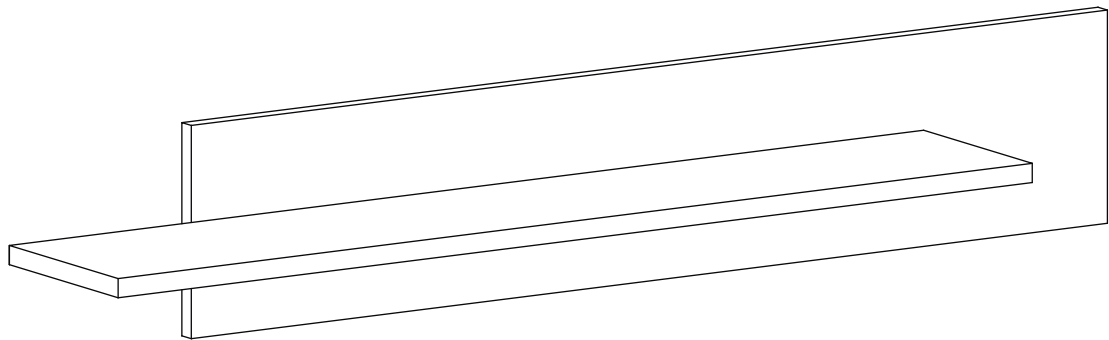

**7-9**

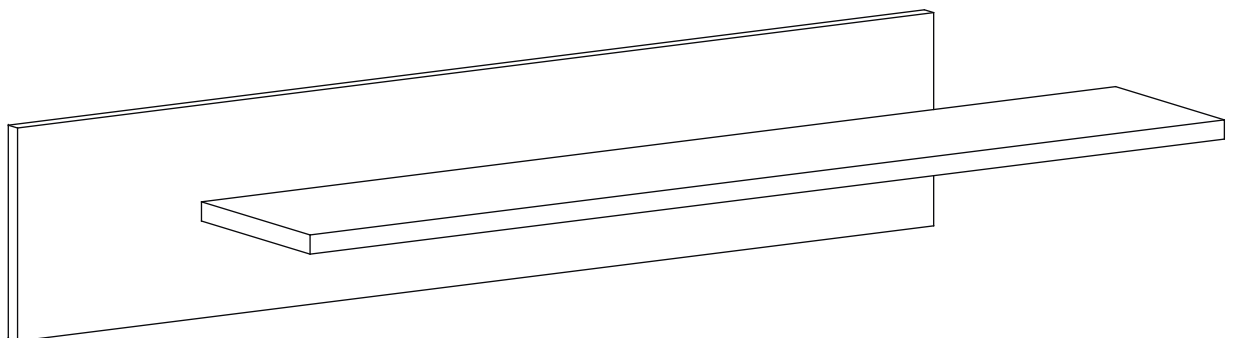

GALINO 23\_MX

1

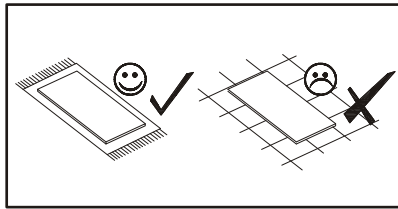

ZM1  
x4

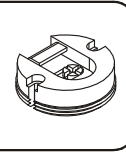

D20  
x8

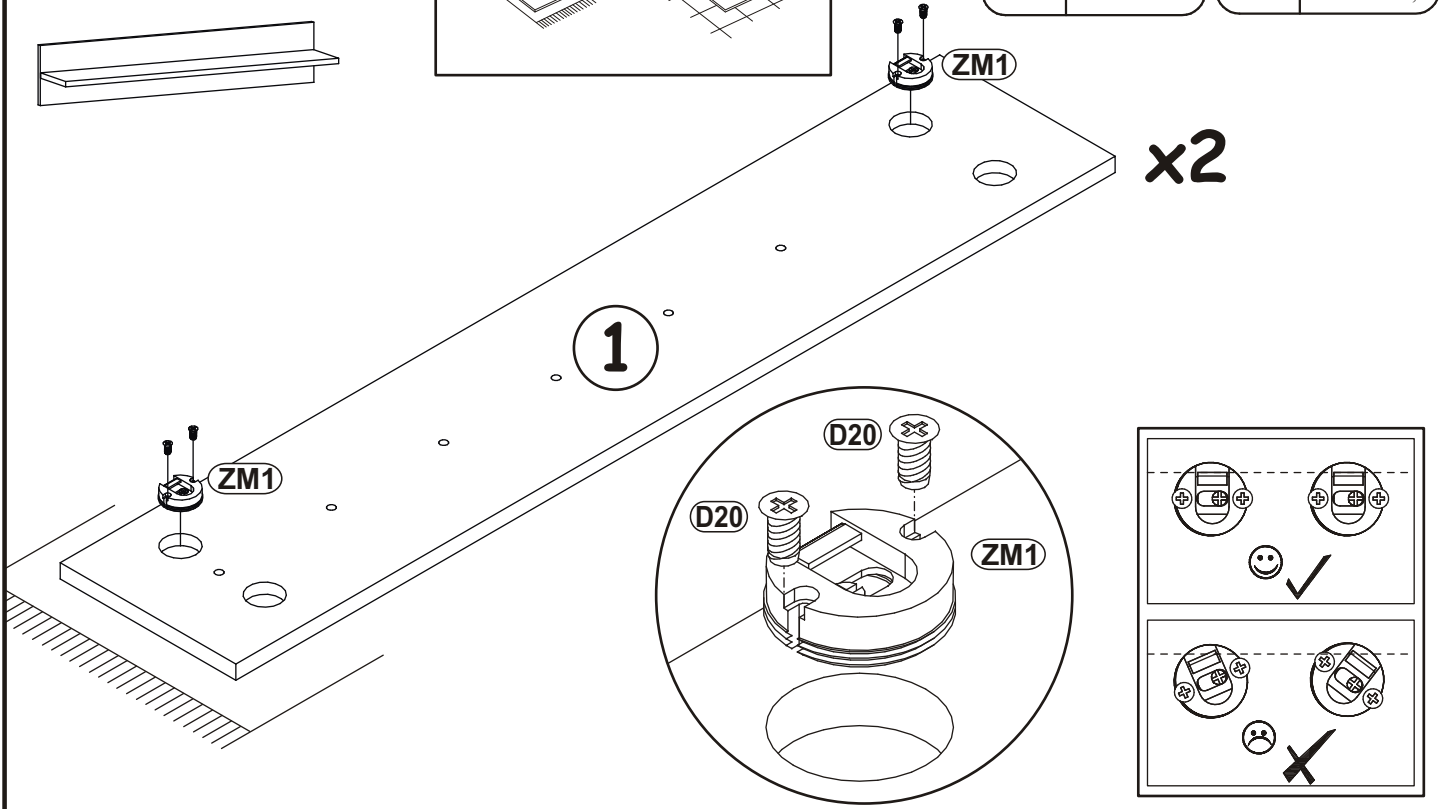
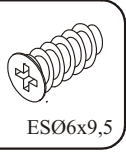

2

B11  
x12

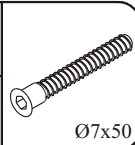

G4  
x12

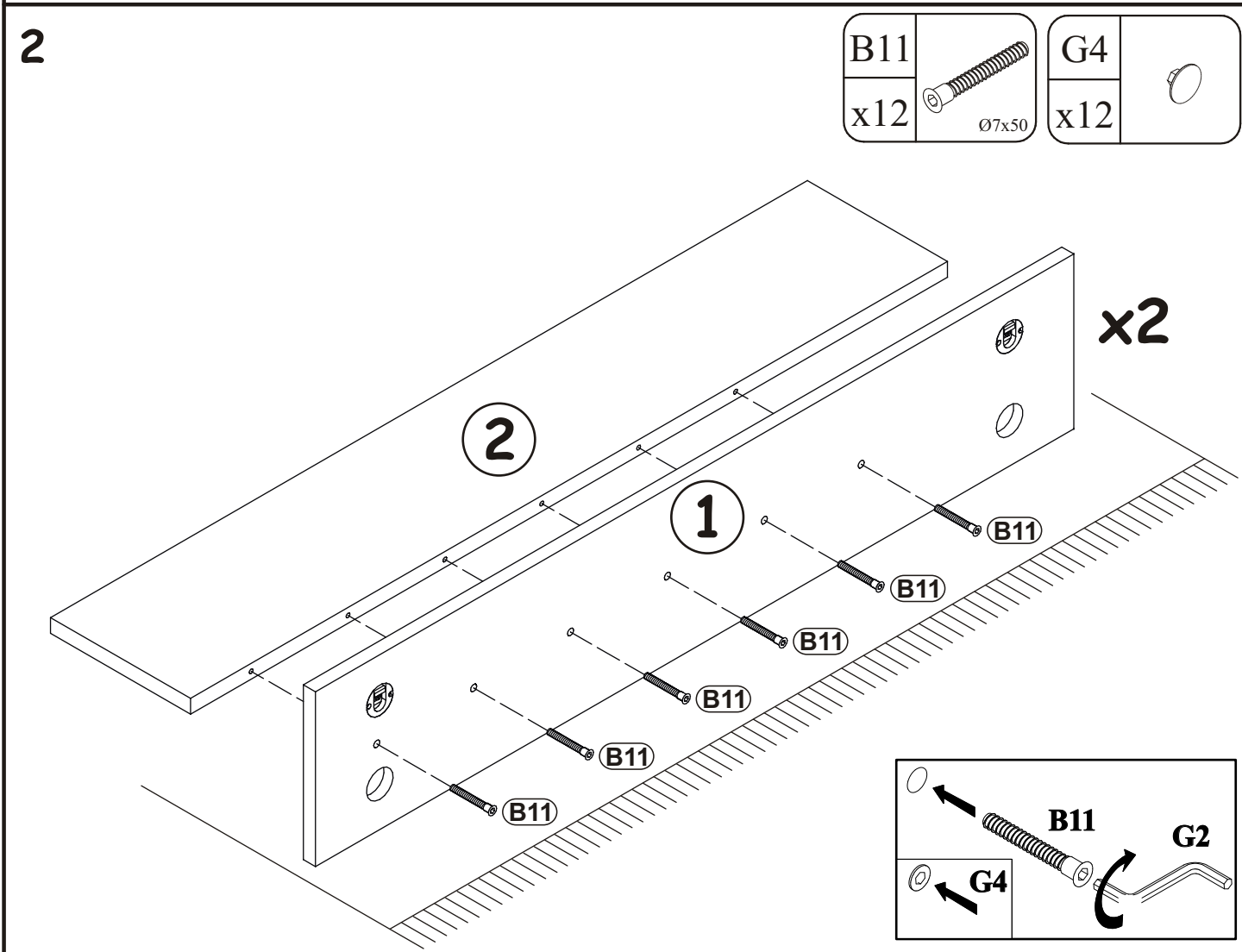
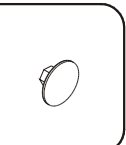

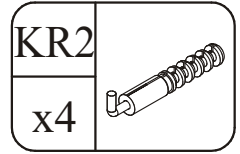

3

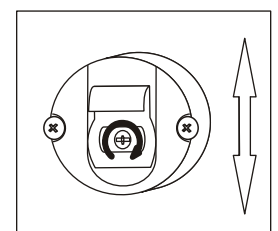
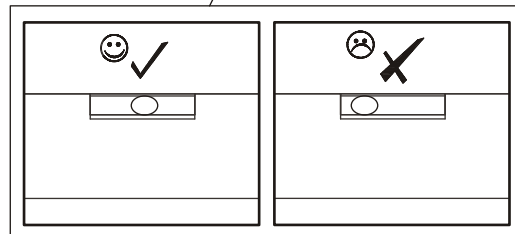
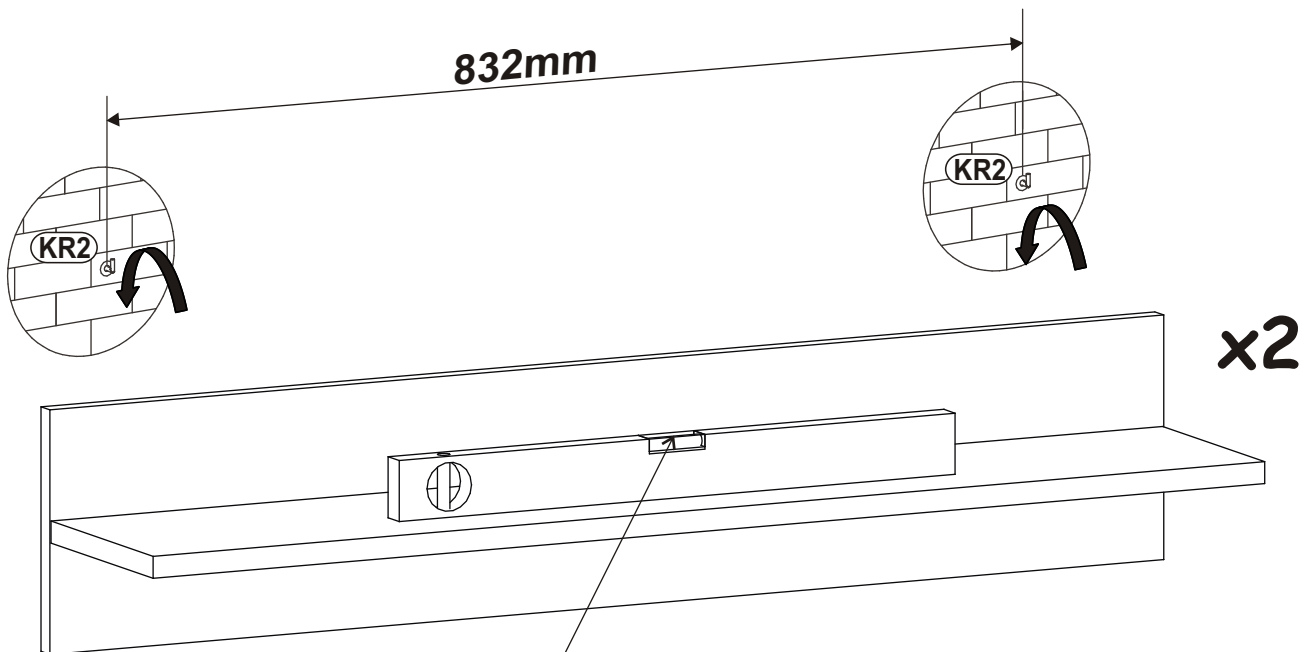
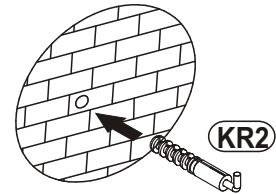
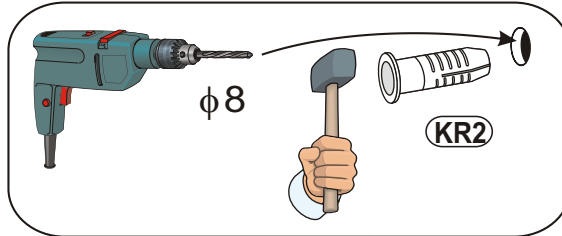
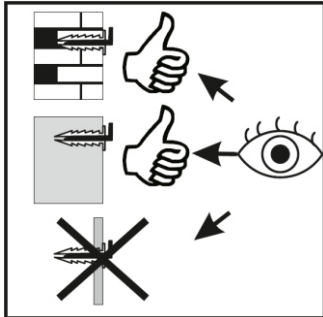

4

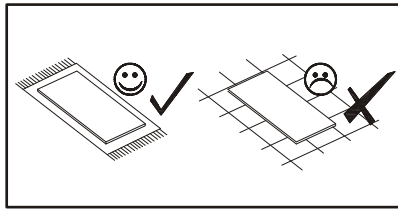

ZM1		D20	
x4		x8	ESØ6x9,5

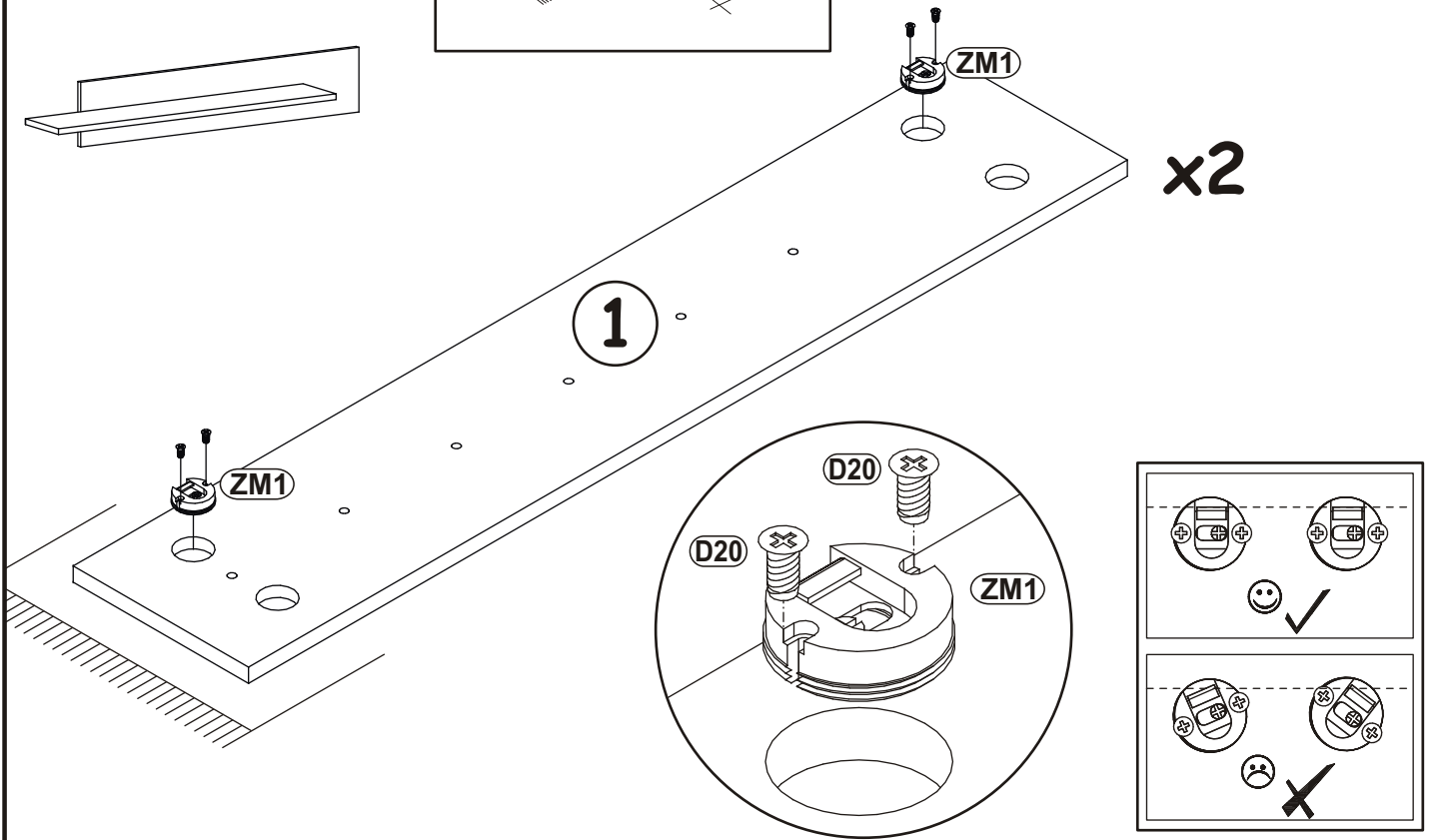

5

B11		G4	
x12	Ø7x50	x12	

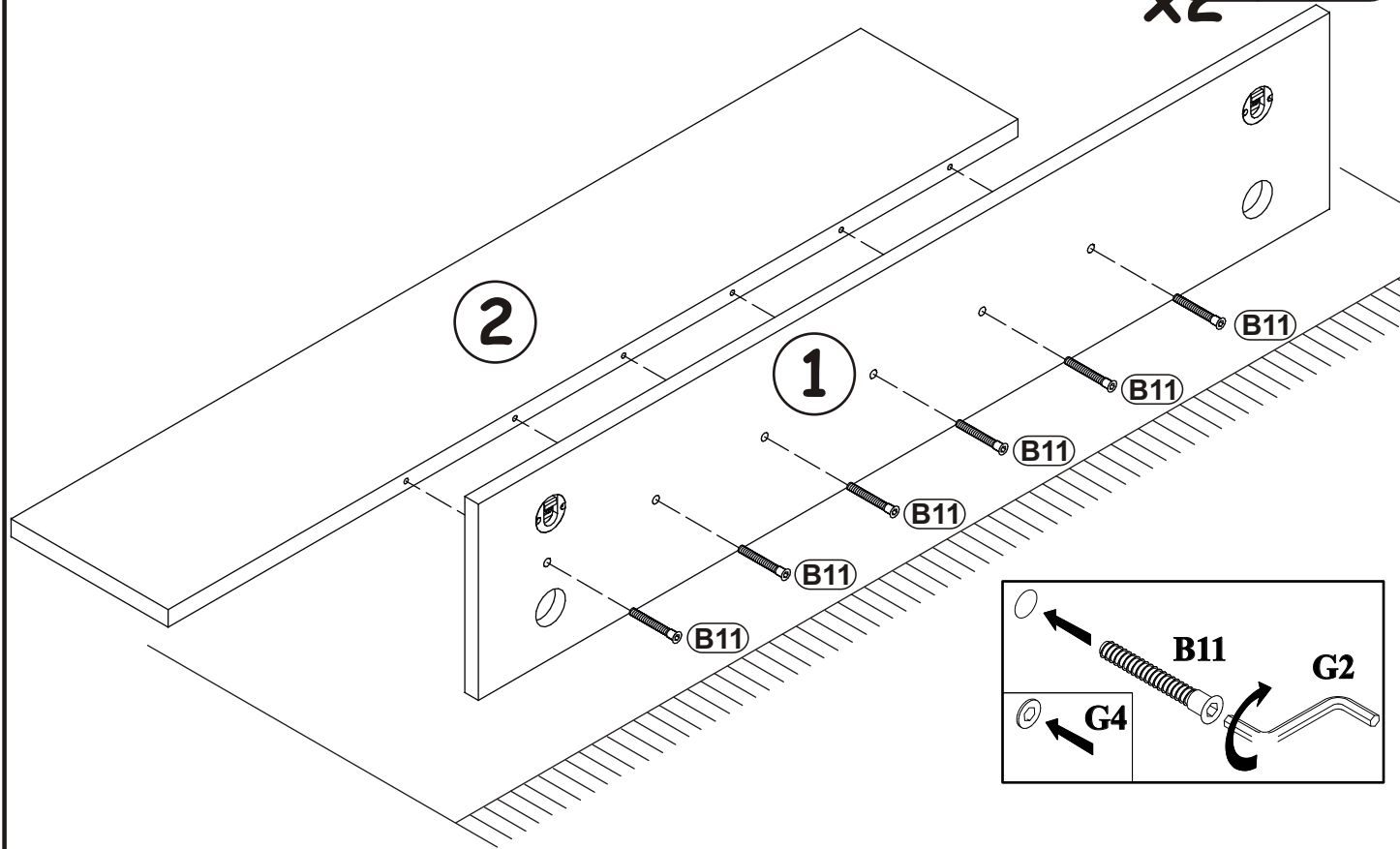

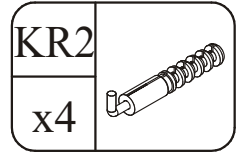

6

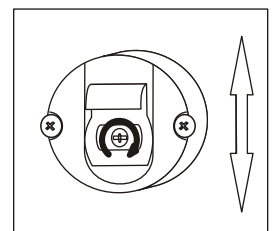
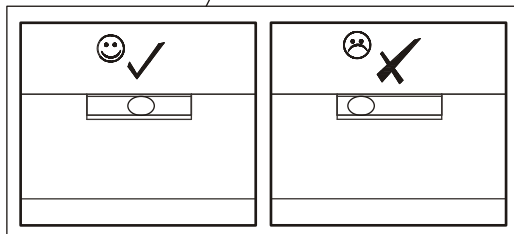
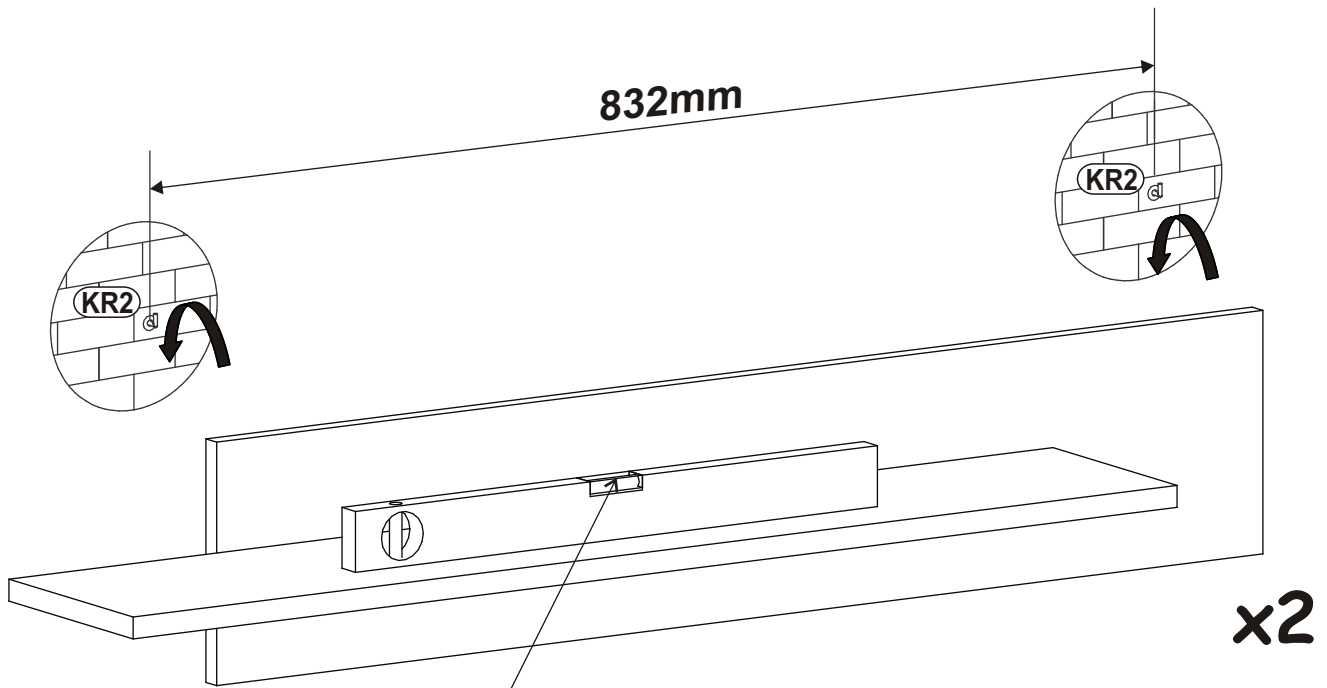
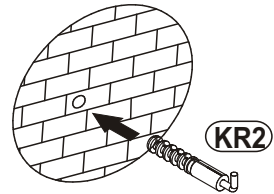
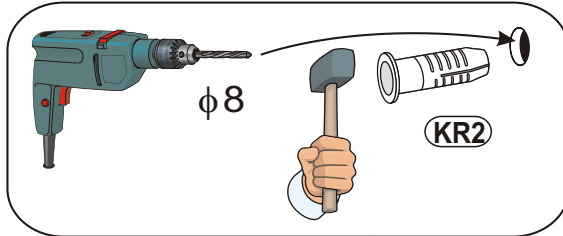
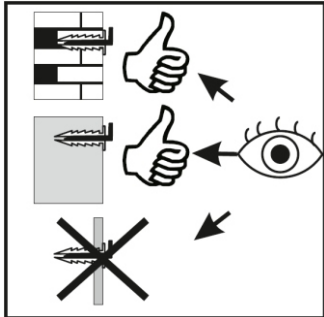



7

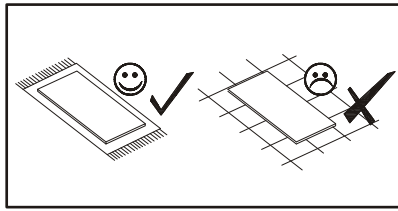

ZM1		D20	
x4		x8	ESØ6x9,5

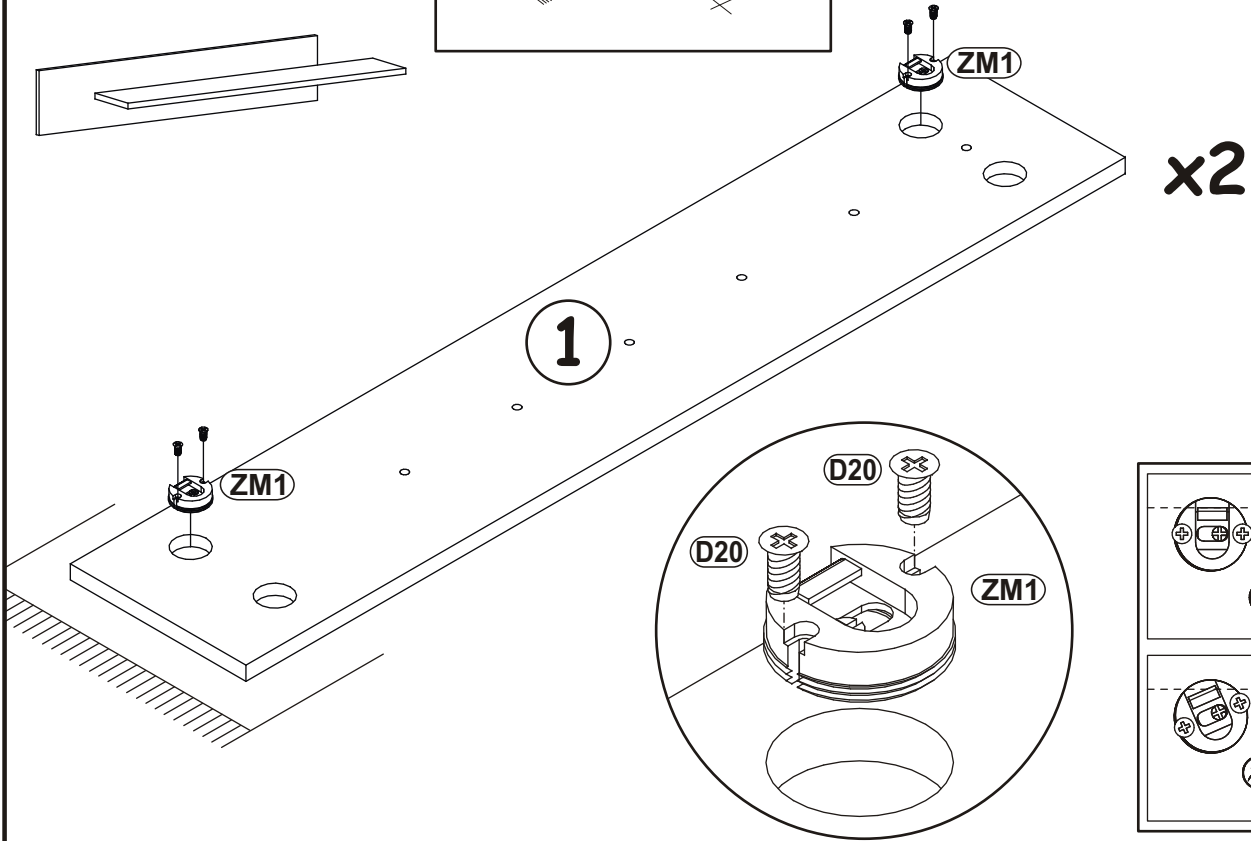

8

B11		G4	
x12	Ø7x50	x12	

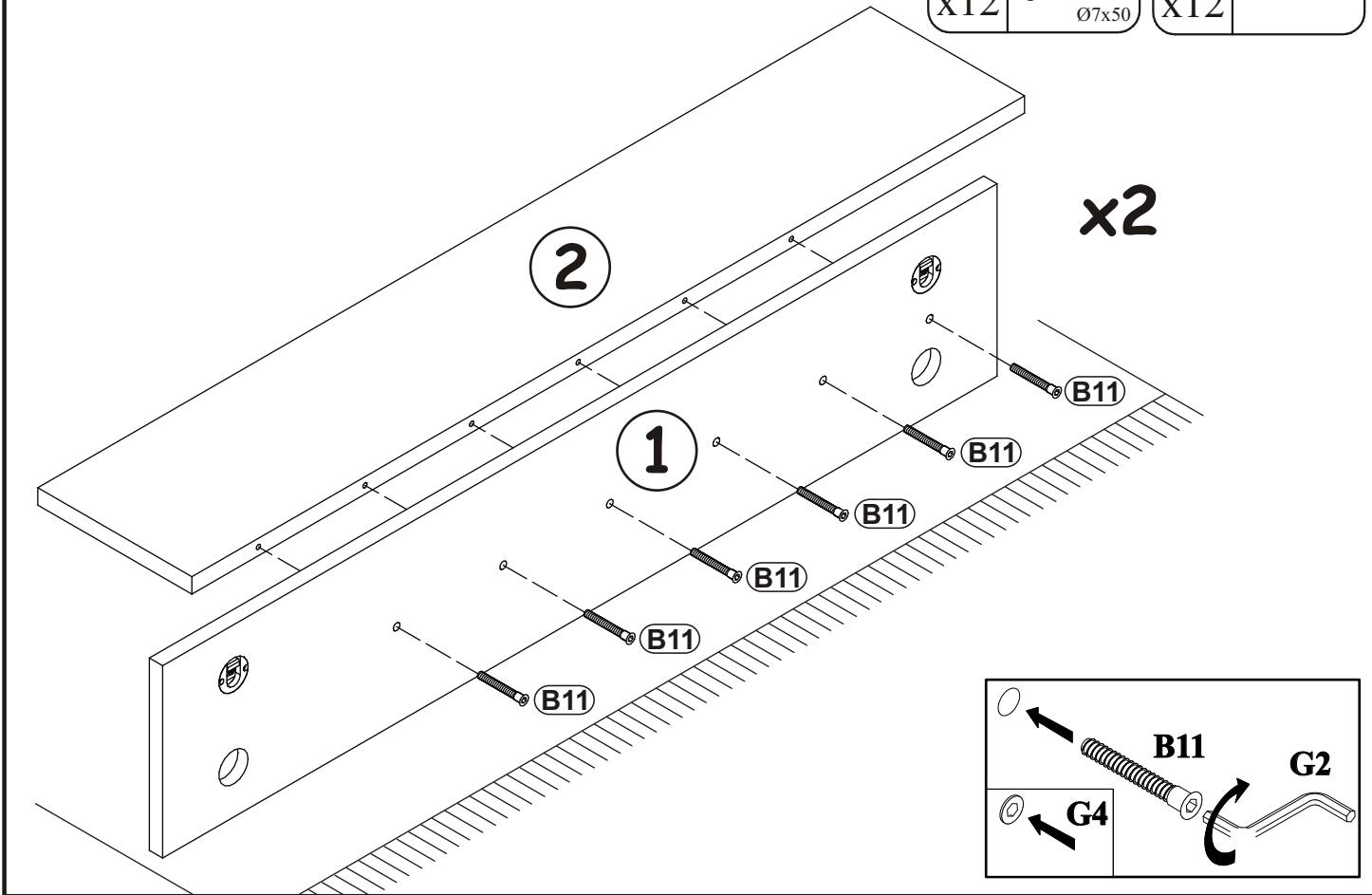

9

KR2	
x4	

