

ARMARIO / GUSTAVO / PEDRO TYP H

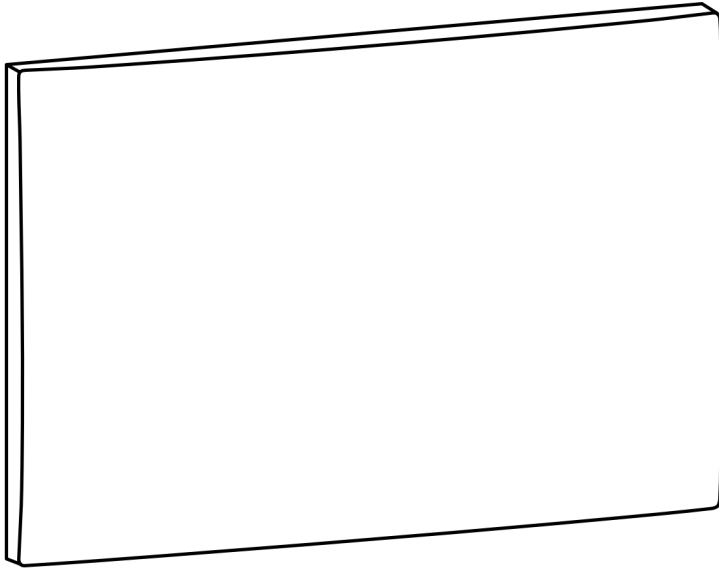

3x

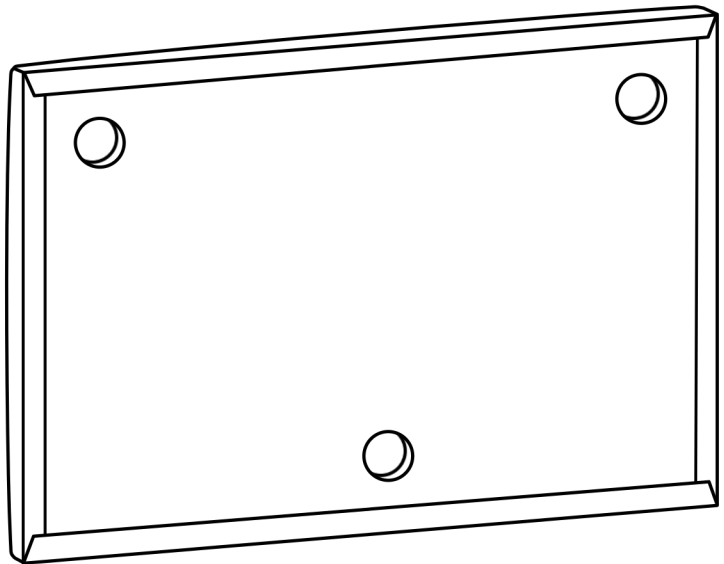

NO	Dim.		Col.-No	Qty
1	600	390	1	3

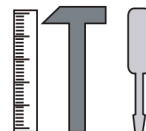
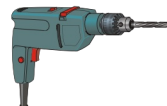

40 min

AR / GV / PD TYP H

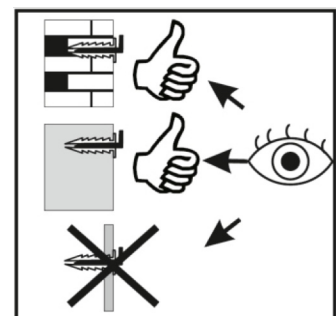
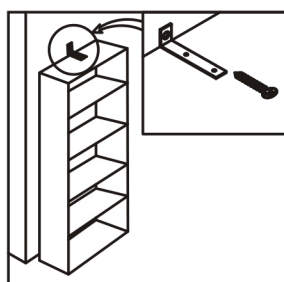
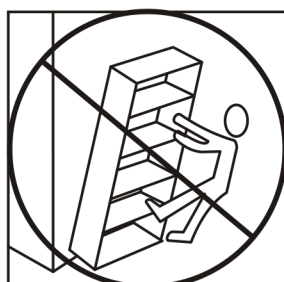
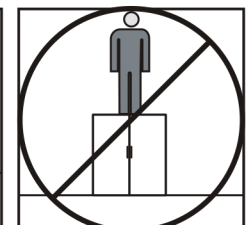
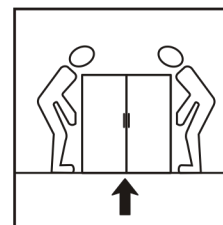
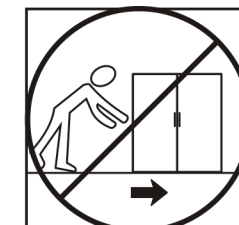
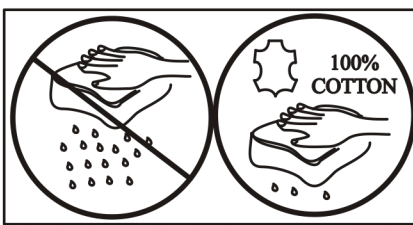
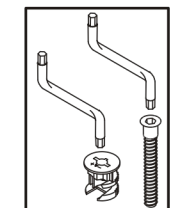
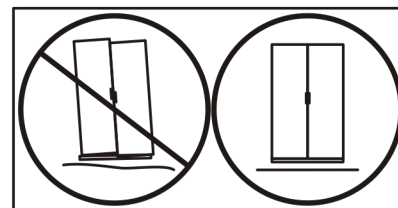
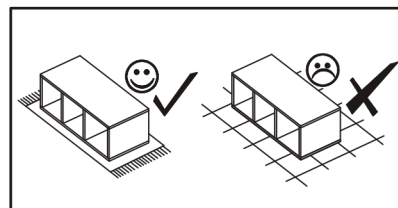
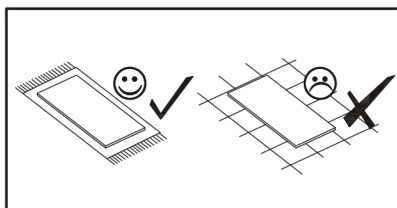
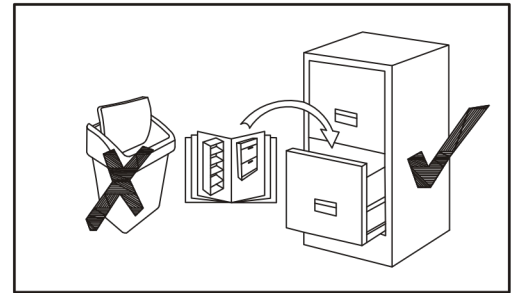
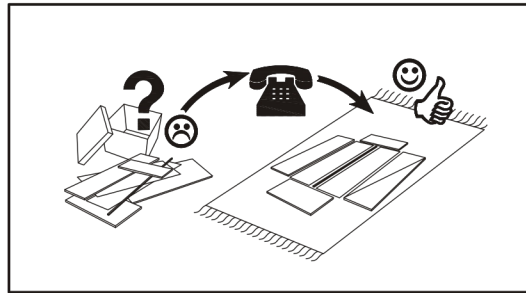
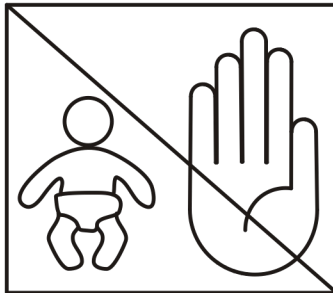
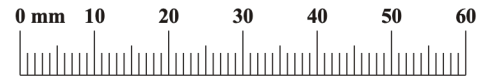
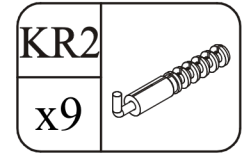
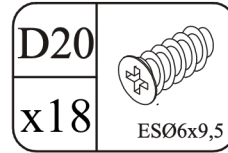
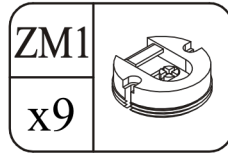

AR / GV / PD TYP H

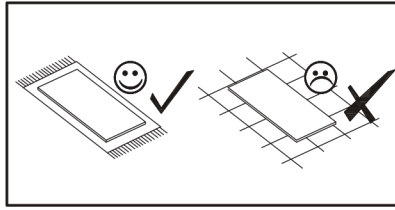

ZM1		D20	
x3		x6	ESØ6x9,5

3x

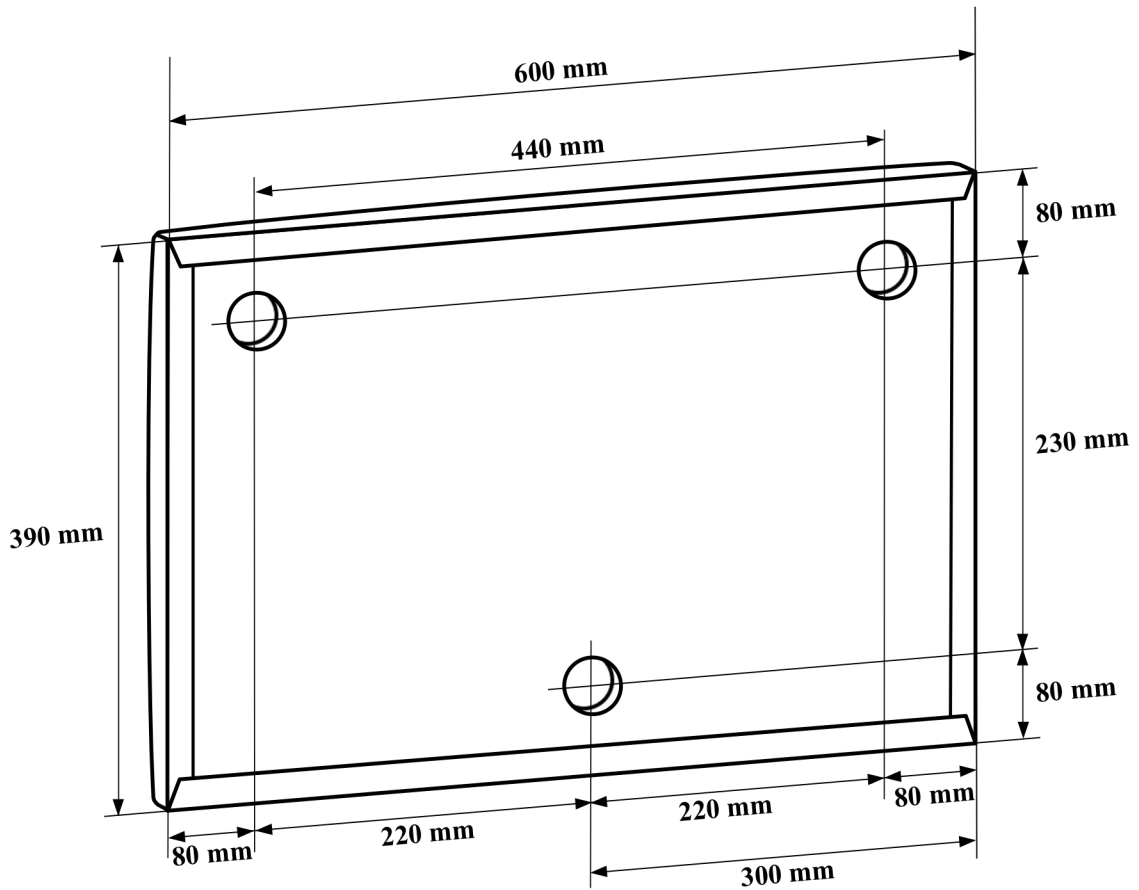
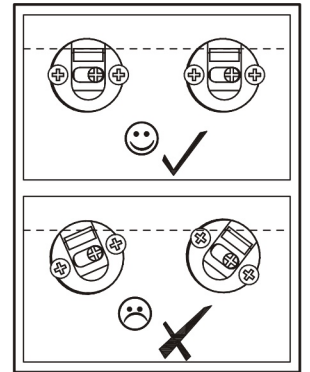
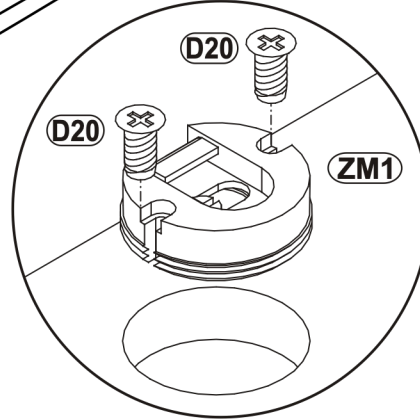
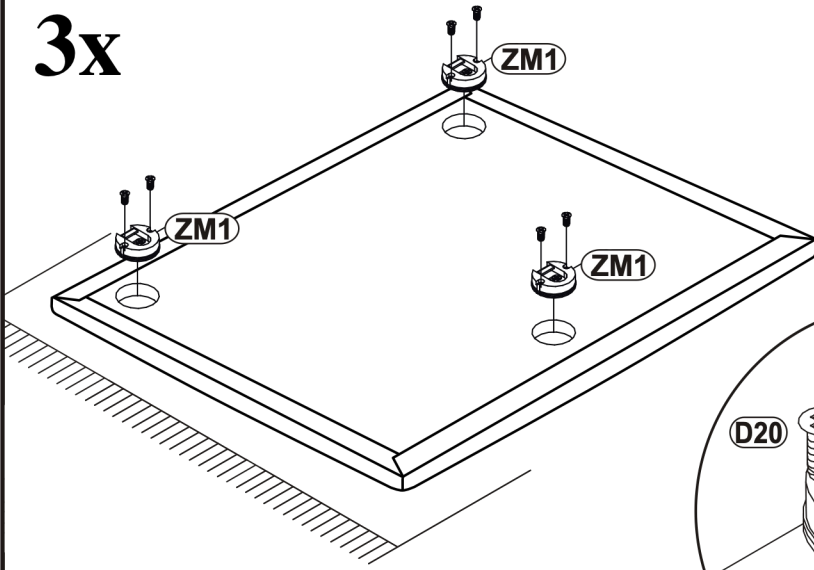

AR / GV / PD TYP H

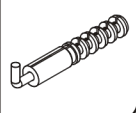
KR2	
x9	

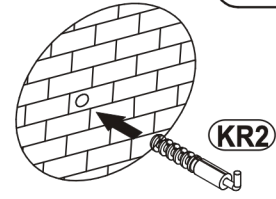
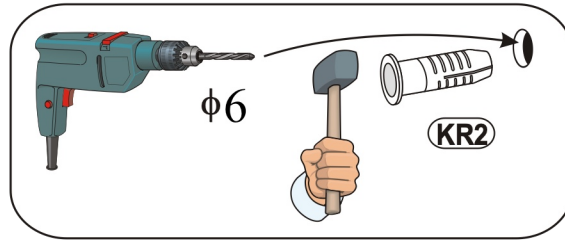
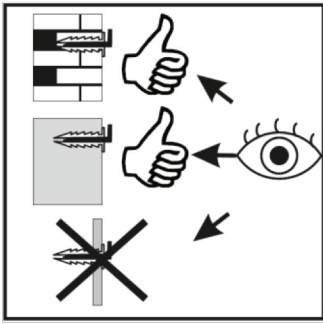

3x

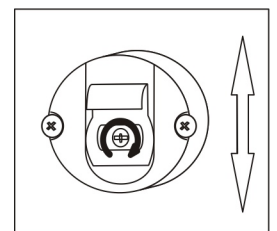
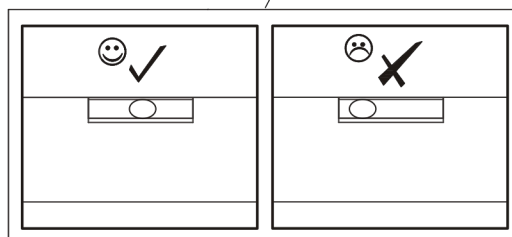
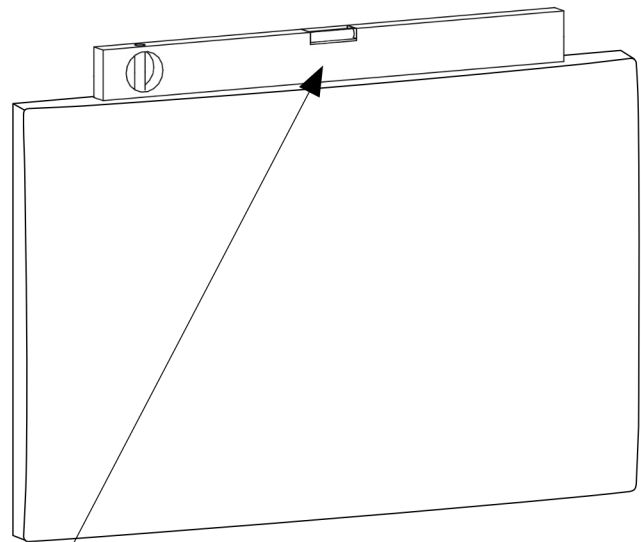
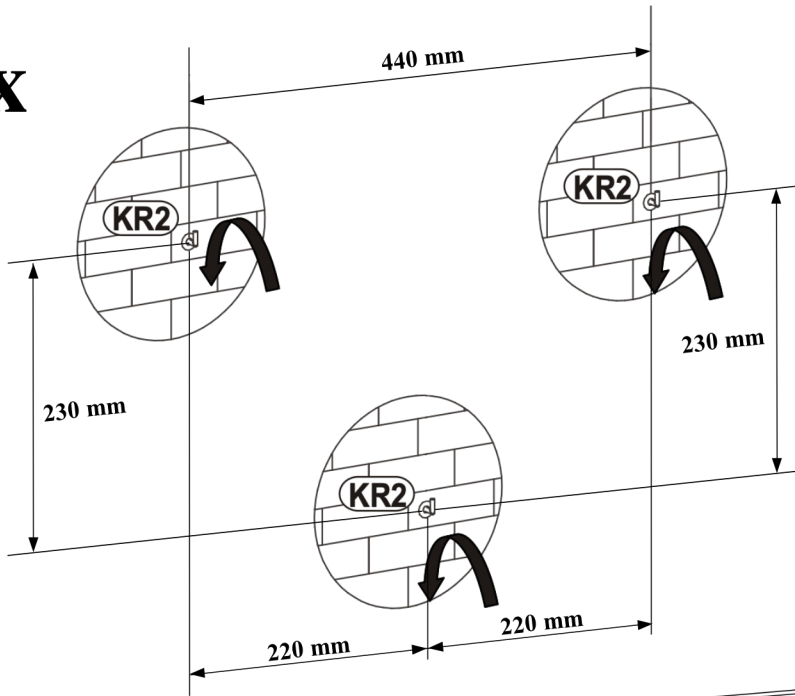

PEDRO HJZ PD ___ TYP H

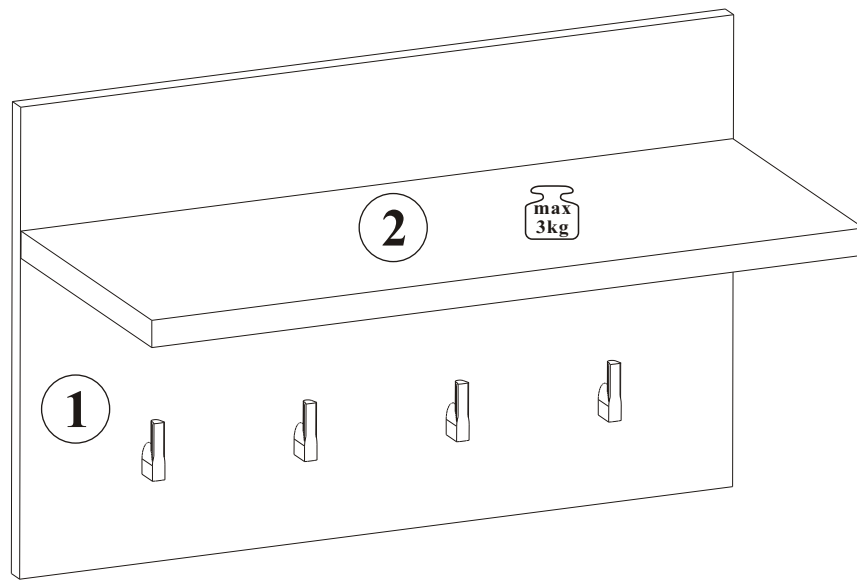
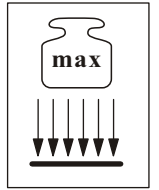

NO	DIM [mm]		COL.-NO	QTY
1	600	381	16	1/1
2	599	250	22	1/1

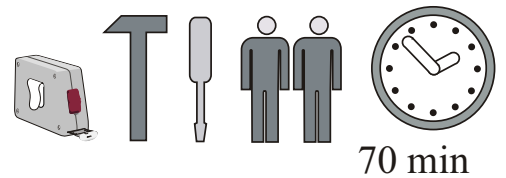

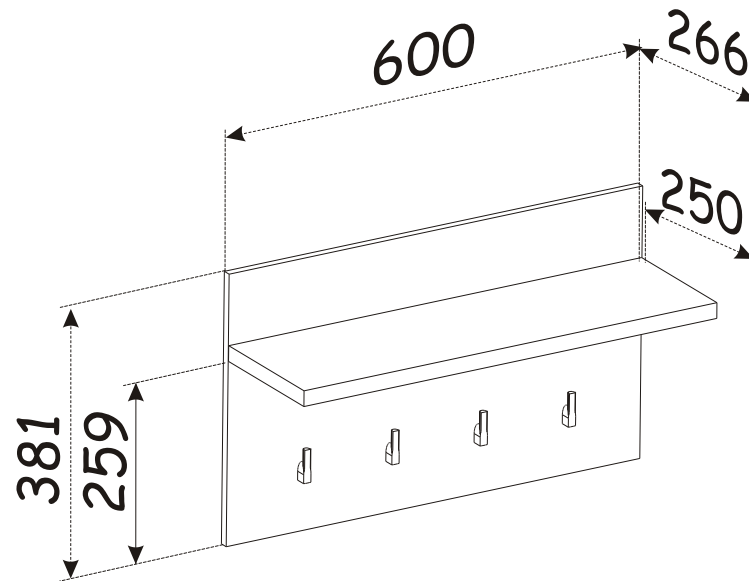

70 min

PEDRO HJZ PD _ TYP H

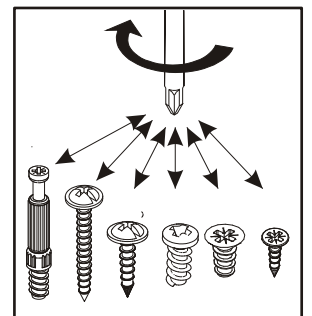
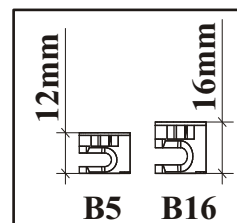
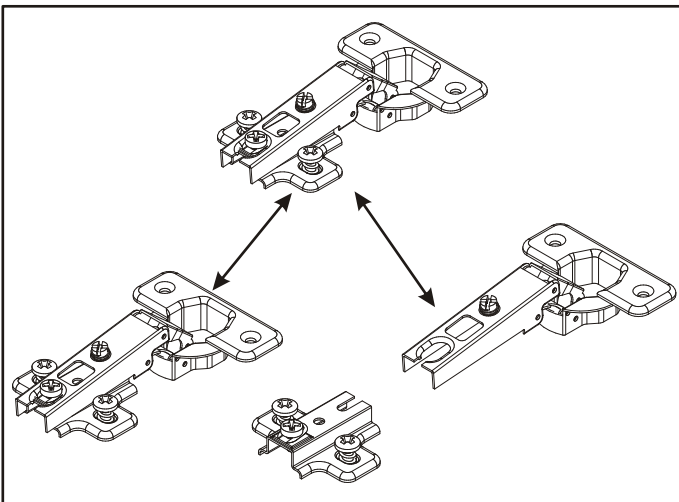
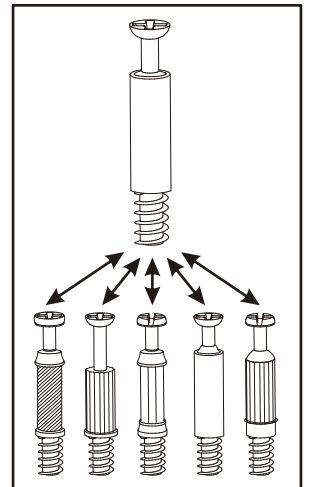
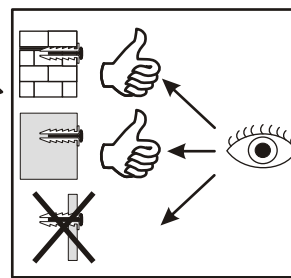
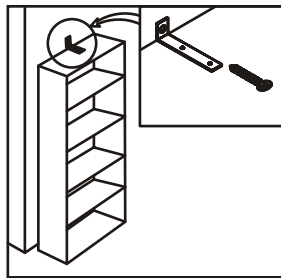
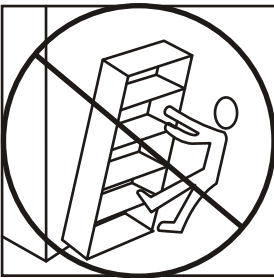
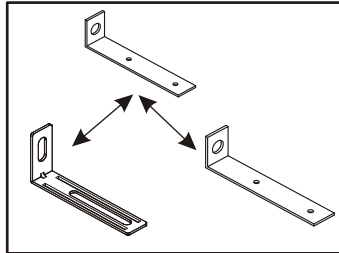
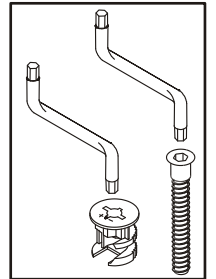
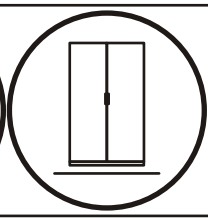
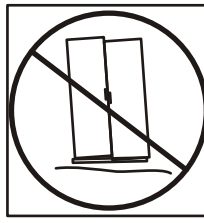
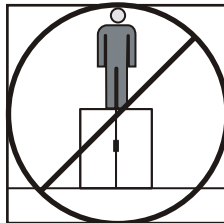
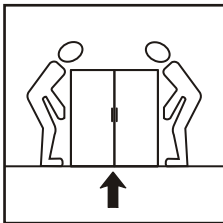
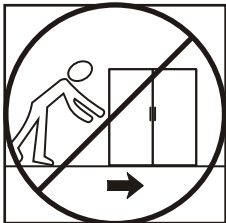
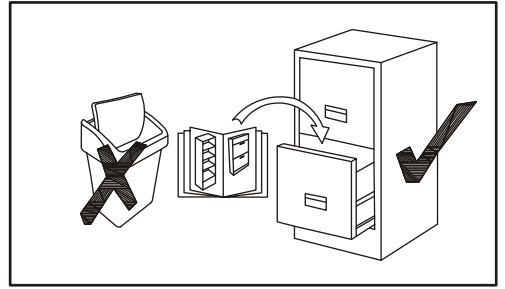
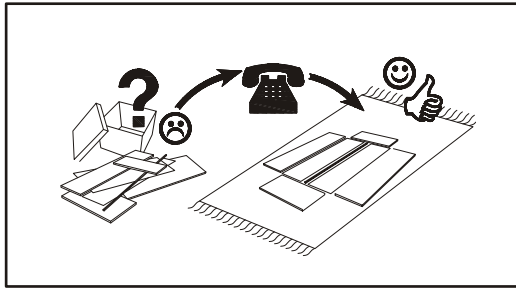
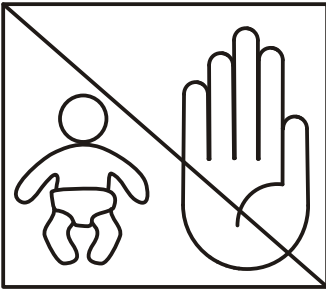
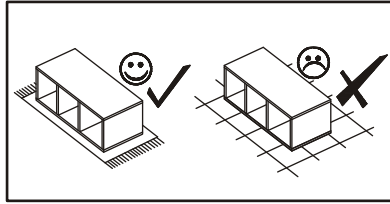
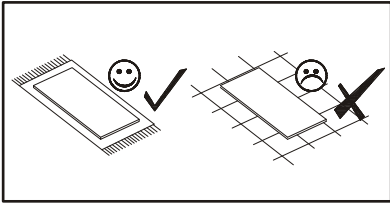

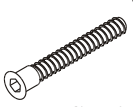

PEDRO HJZ PD _ TYP H

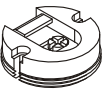
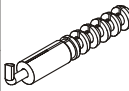
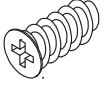
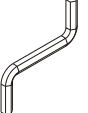
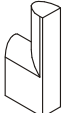
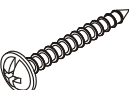
<p>B11</p> <p>x5</p>	 <p>Ø7x50</p>	<p>G4</p> <p>x5</p>	 <p>C</p>	<p>ZM1</p> <p>x3</p>		<p>KR3</p> <p>x3</p>	 <p>Ø10</p>	<p>D20</p> <p>x6</p>	 <p>ESØ6,3x9,5</p>	<p>G2</p> <p>x1</p>	
<p>WS1</p> <p>x4</p>		<p>UP6</p> <p>x8</p>	 <p>UPØ4x30</p>								

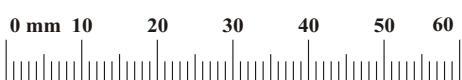

1

ZM1		D20	
x3		x6	ESØ6,3x9,5

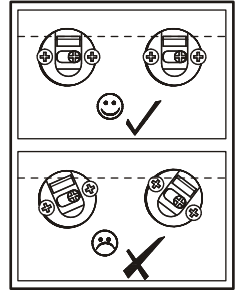
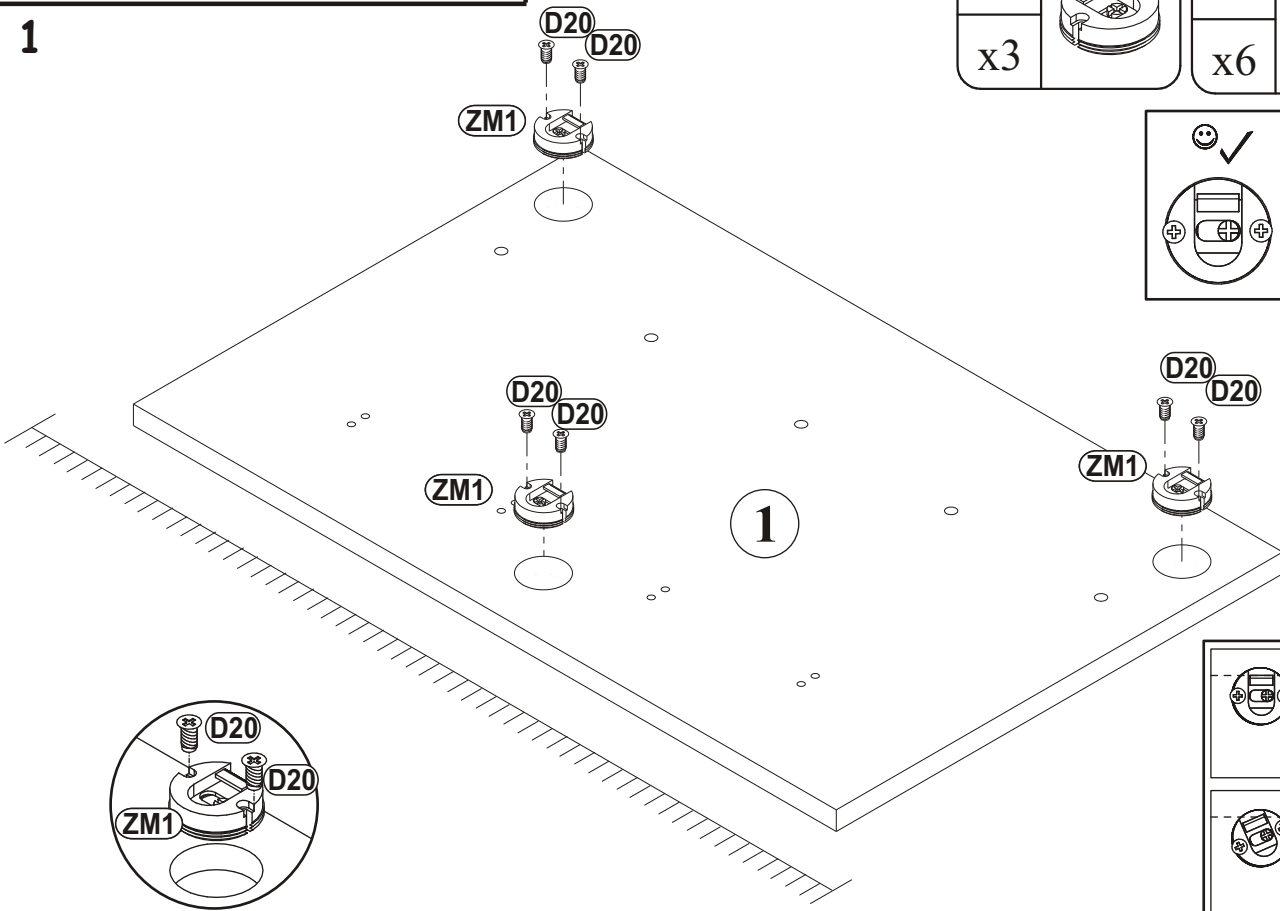
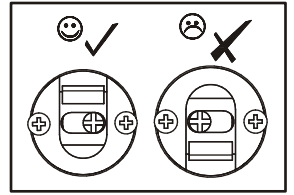



2

B11		G4	
x5	Ø7x50	x5	C

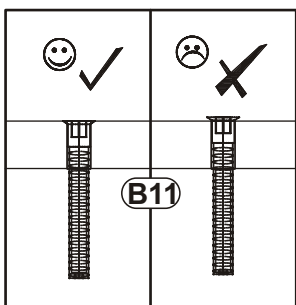
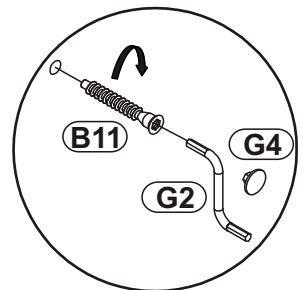
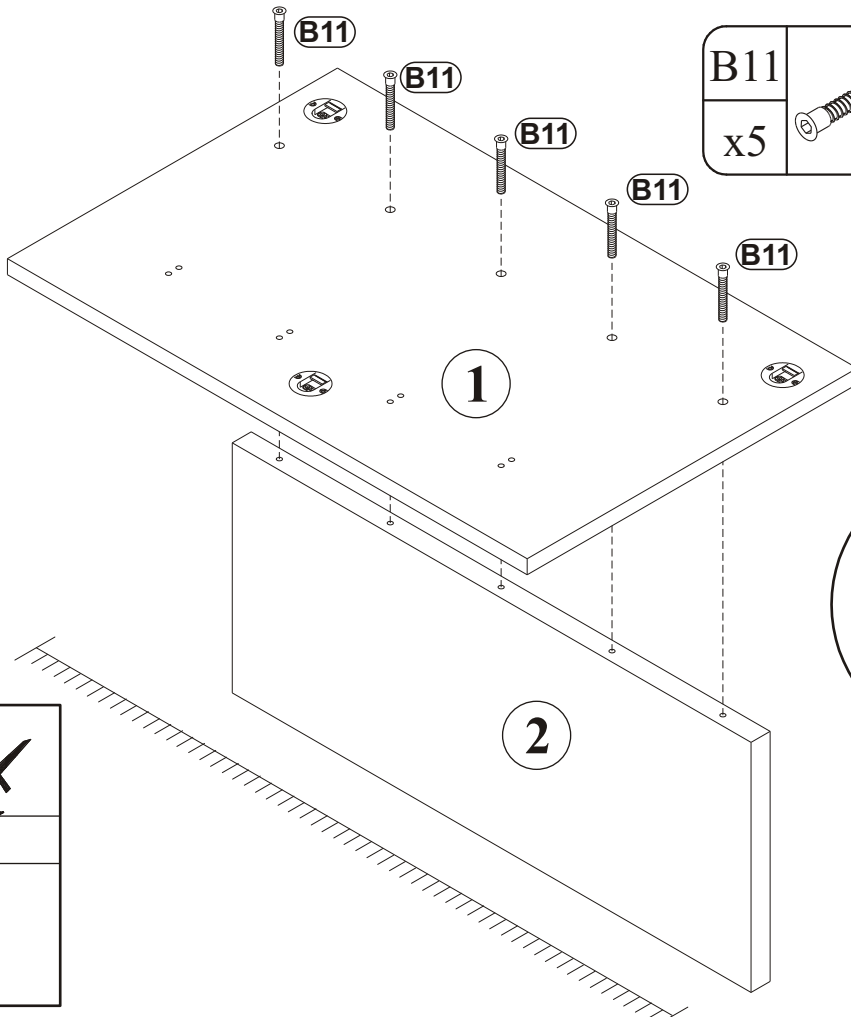
G2	
x1	

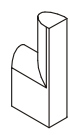

3

WS1		UP6	
x4		x8	UPØ4x30

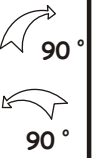
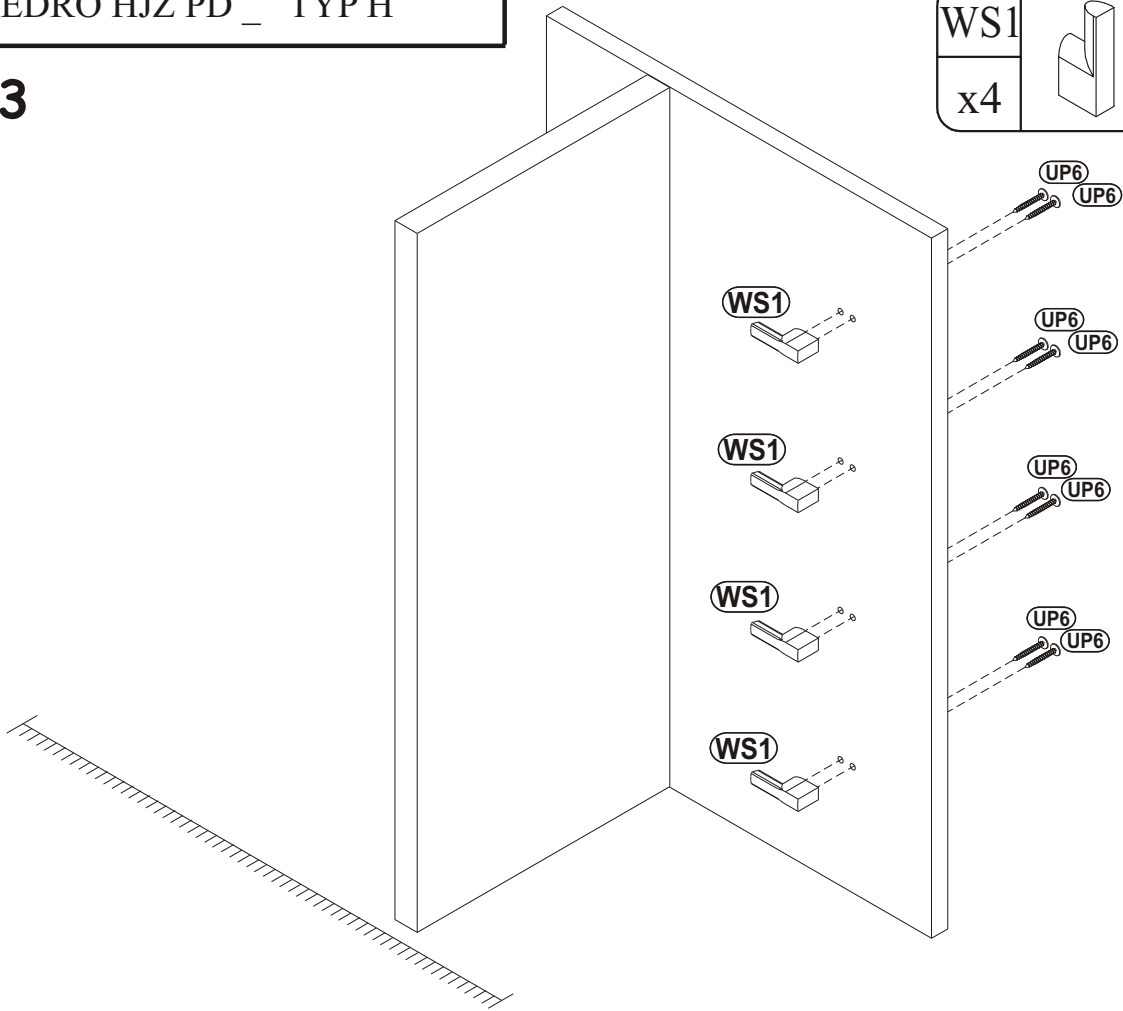

4

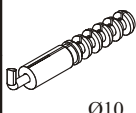
KR3	
x3	Ø10

