

# PEDRO HJZ PD \_\_ TYP G

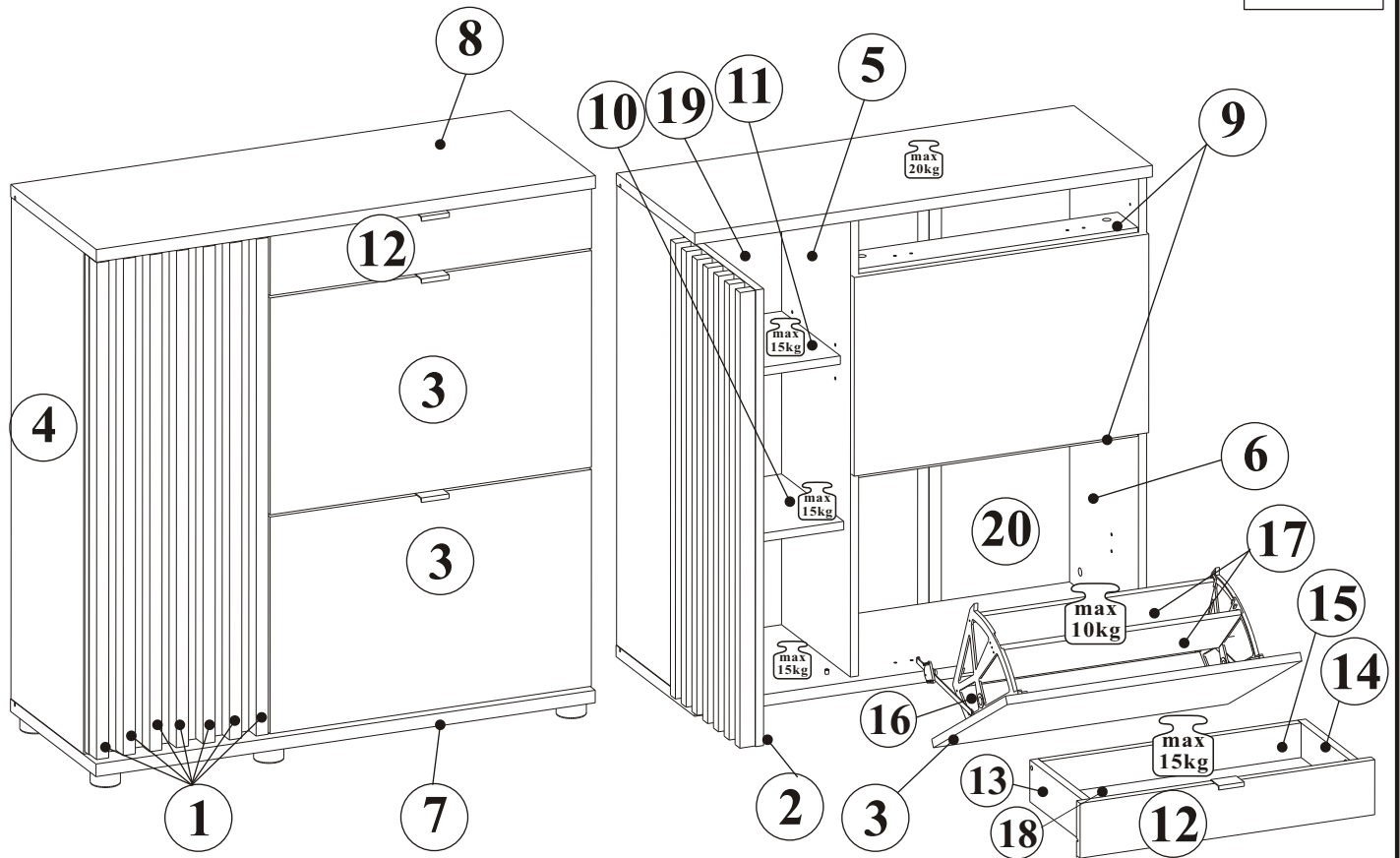

NO	DIM [mm]		COL.-NO	QTY
1	871	30	22 2/2	7
2	312	873	16 2/2	1
3	580	380	16 1/2	2
4	880	297	16 2/2	1
5	880	307	16 2/2	1
6	880	327	16 2/2	1
7	901	350	22 2/2	1
8	901	350	22 2/2	1
9	551	90	16 1/2	2
10	300	277	16 1/2	1
11	300	262	16 1/2	1
12	580	102	16 1/2	1
13	250	80	16 1/2	1
14	250	80	16 1/2	1
15	511	66	16 1/2	1
16	475	80	12 1/2	2
17	475	140	12 1/2	4
18	523	253	3 1/2	1
19	892	314	3 2/2	1
20	892	564	3 2/2	1

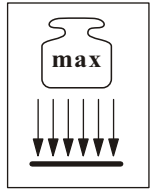

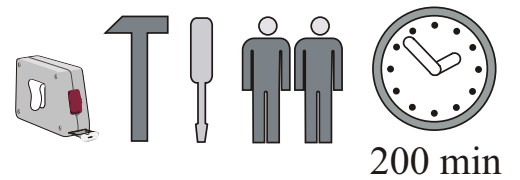

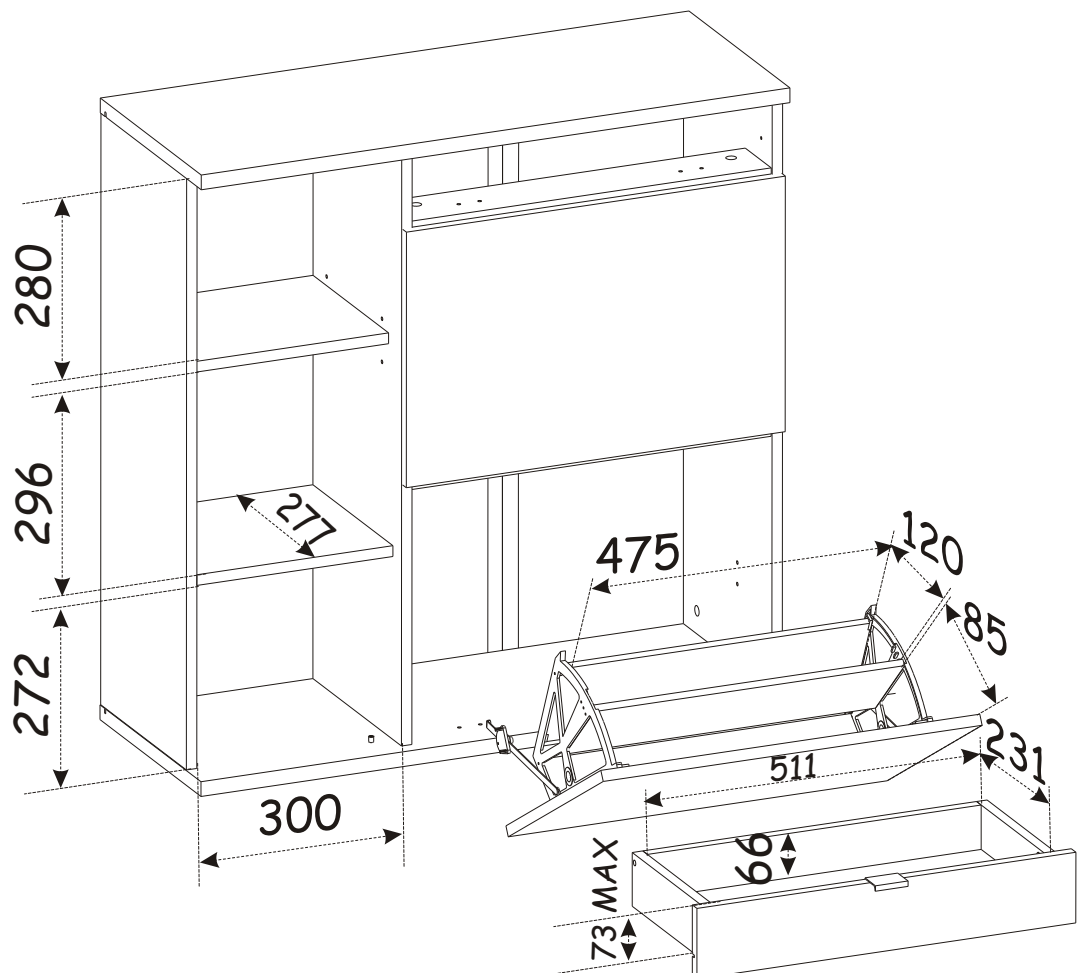
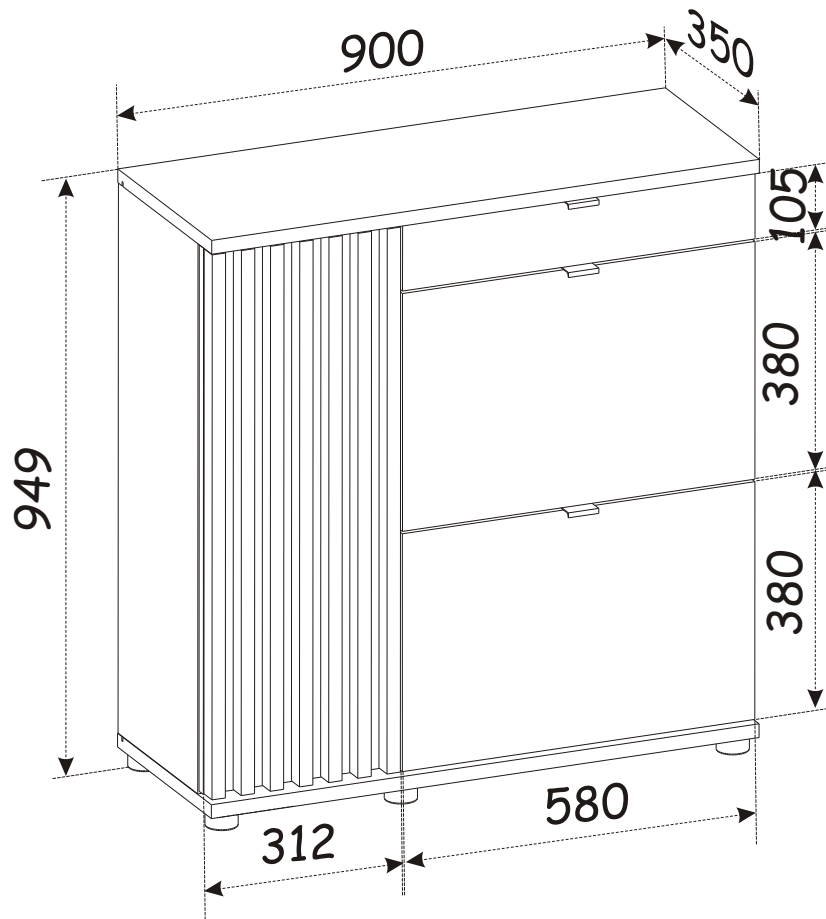

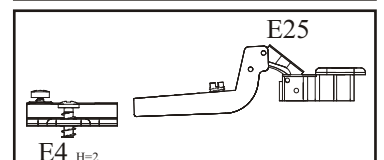
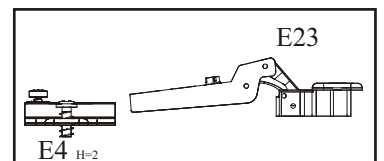
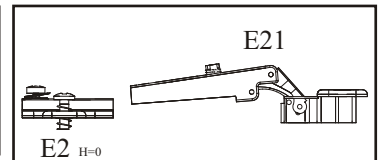
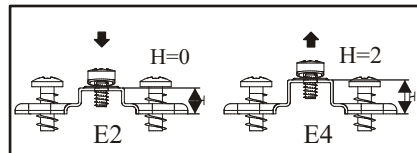
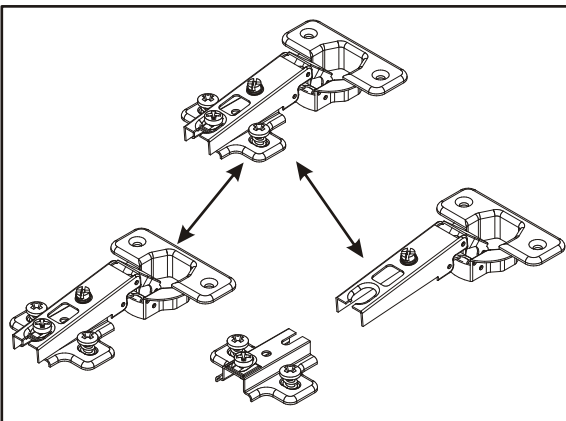
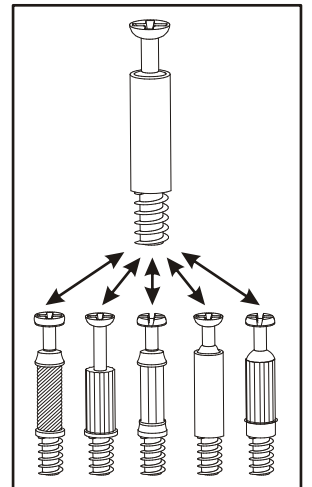
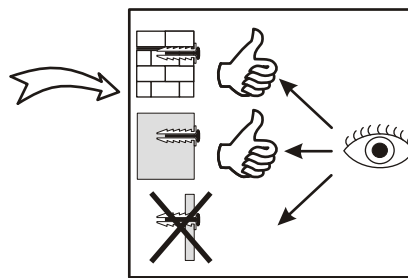
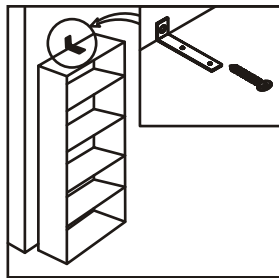
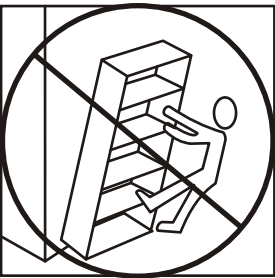
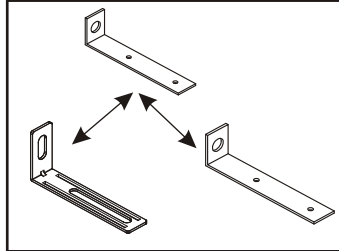
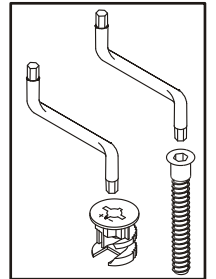
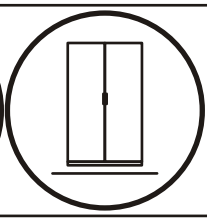
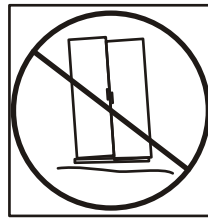
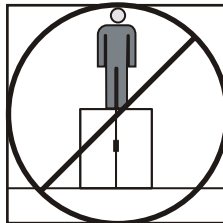
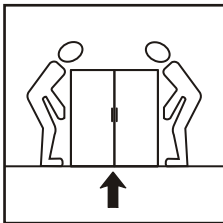
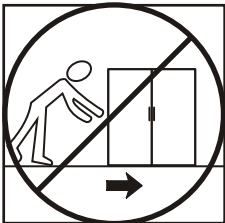
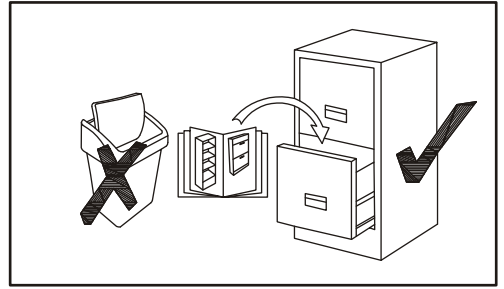
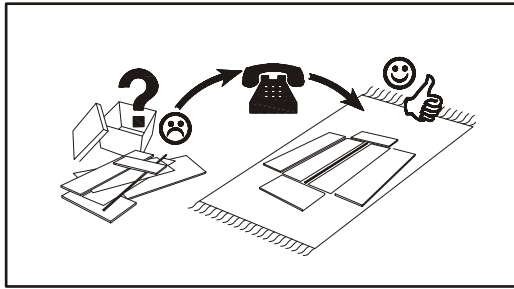
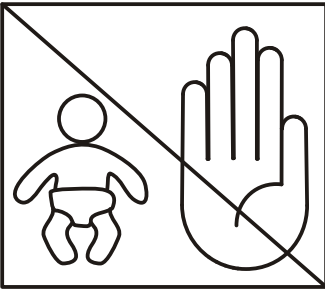
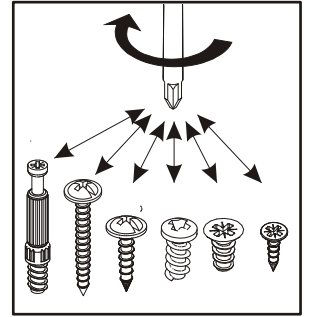
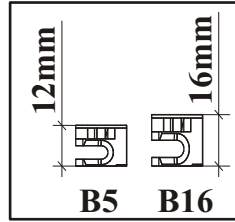
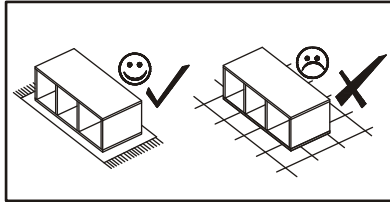
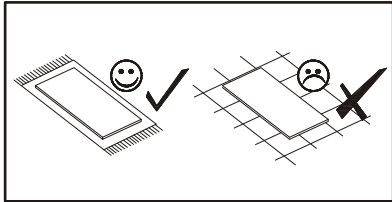



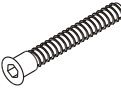

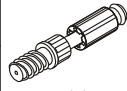

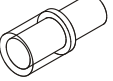
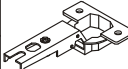
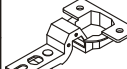
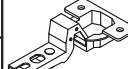
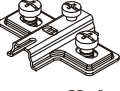
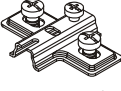
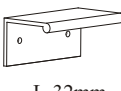
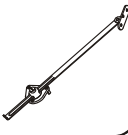
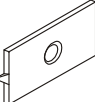
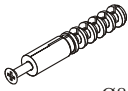
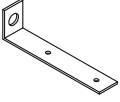
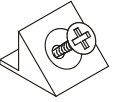
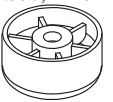

# PEDRO HJZ PD \_ TYP G



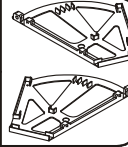

PEDRO HJZ PD \_\_ TYP G

A1 x24 ø8x36		B11 x2 ø7x50		B22 x21 ø7x40		G4 x20		B4 x22 34		B5 x22 ø15x12	
G5 x22		G7 x4		G20 x2		E21 x2 ø35 H=0		E23 x2 ø35 H=8		E25 x2 ø35 H=16	
E2 x2 H=0		E4 x4 H=2		G02 x3 L-32mm.		G21 x4		G16 x6		KR1 x2 ø8	
L1 x2		S1 x14		ST7 x6 ø50, h=25		QU1 x1 L-250mm		UP17 x6 UPø4x25		D7 x12 USø3x16	
D10 x34 USø3,5x13		UP9 x38 UPø3,5x16		D20 x4 ESø6,3x9,5		BU2 x2		G2 x1		G12 x3 ø14	

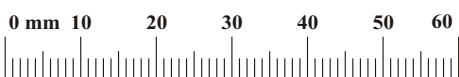

PEDRO HJZ PD \_\_ TYP G

G12		B22		G4	
x3	Ø14	x21	Ø7x40	x18	

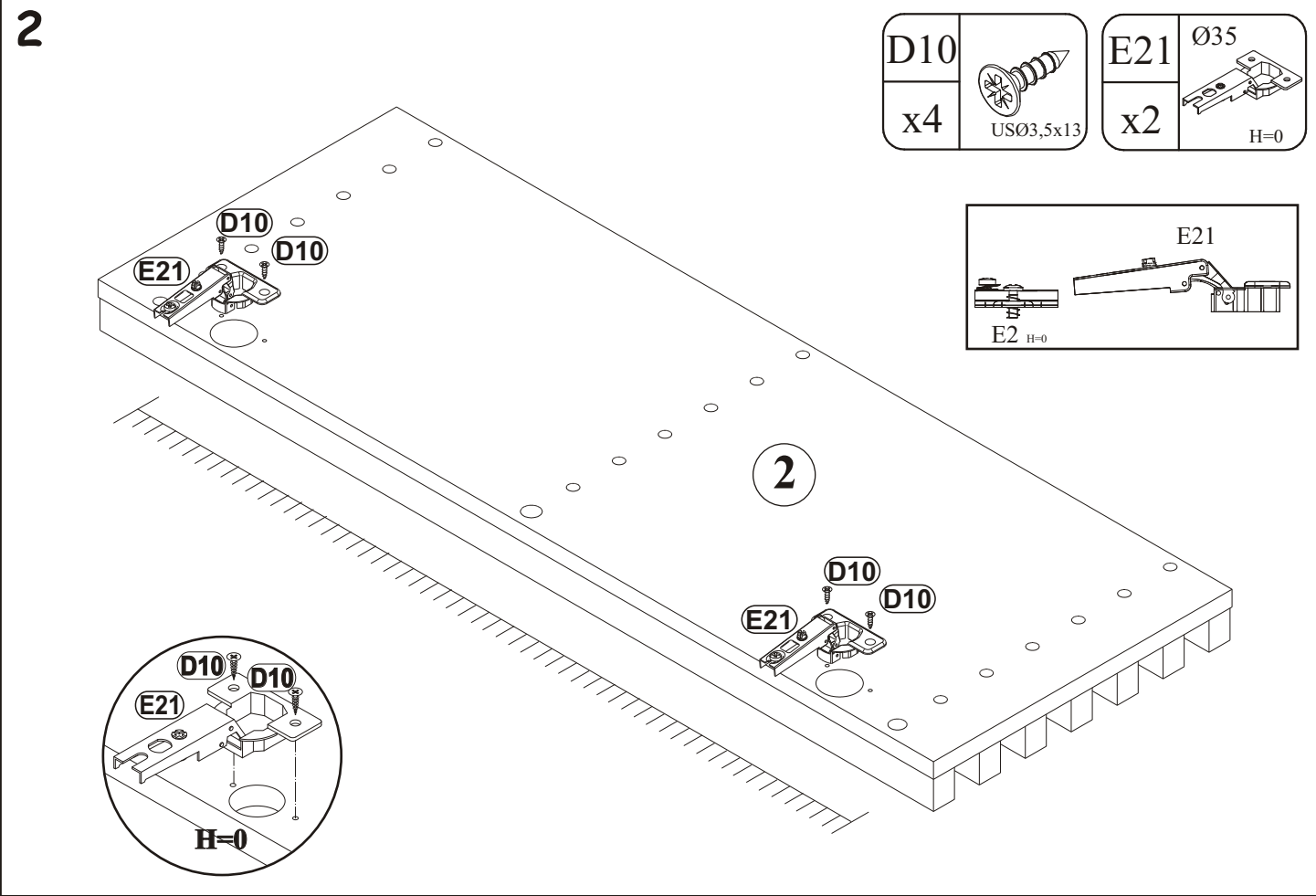
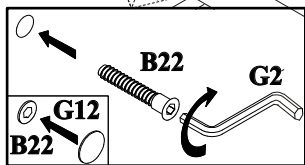
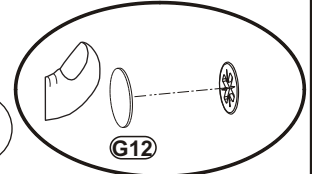
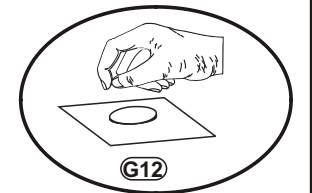
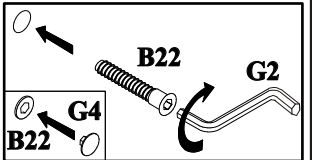
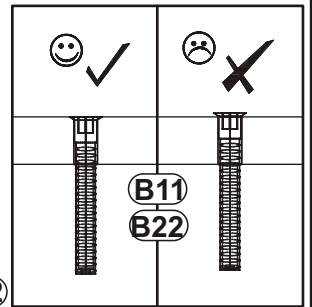
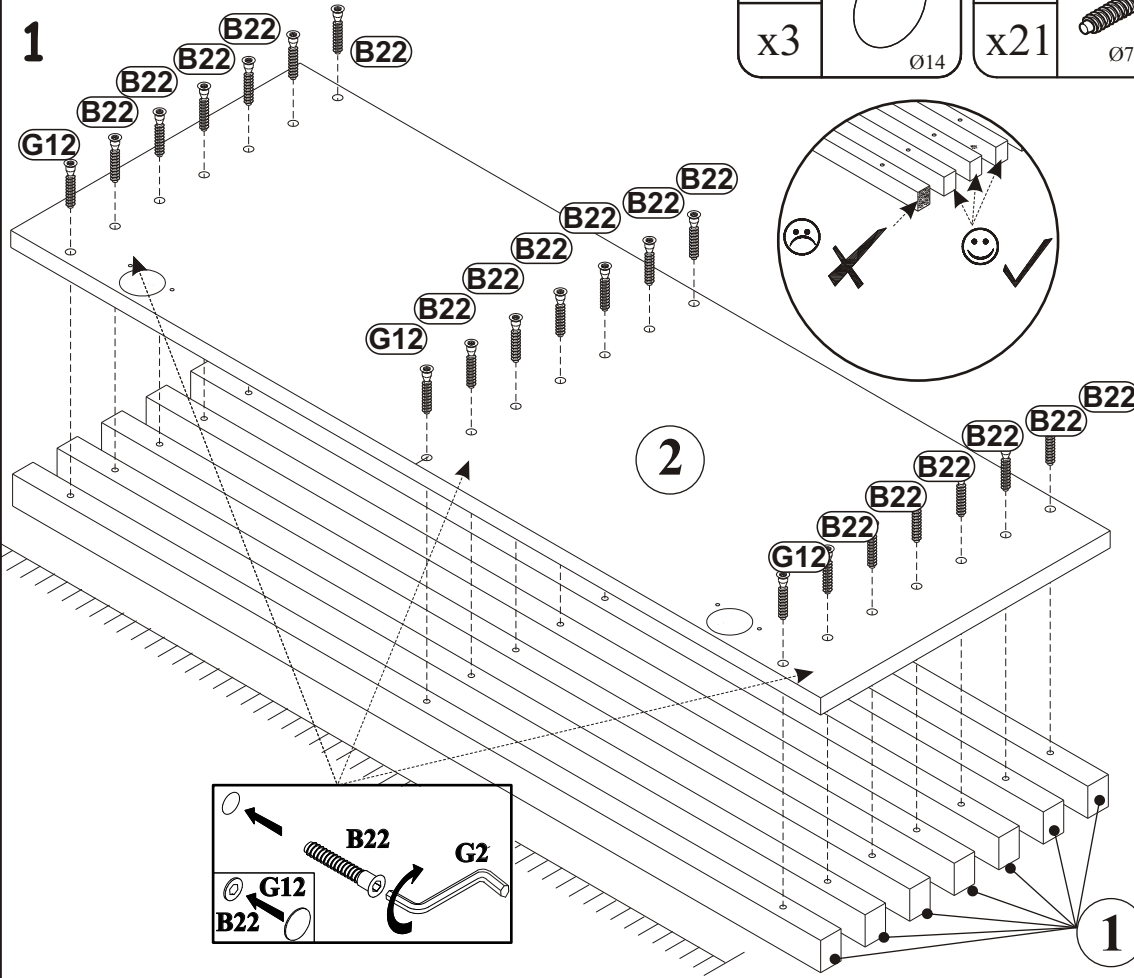

D10		E21	
x4	USØ3,5x13	x2	Ø35 H=0

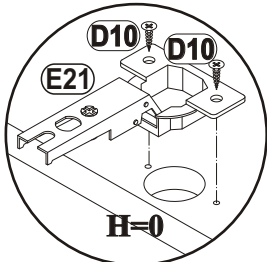
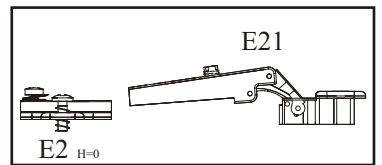

3

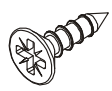
D10	
x8	USØ3,5x13

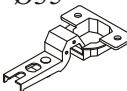
E23	Ø35	
x2	H=8	

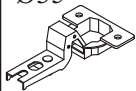
E25	Ø35	
x2	H=16	

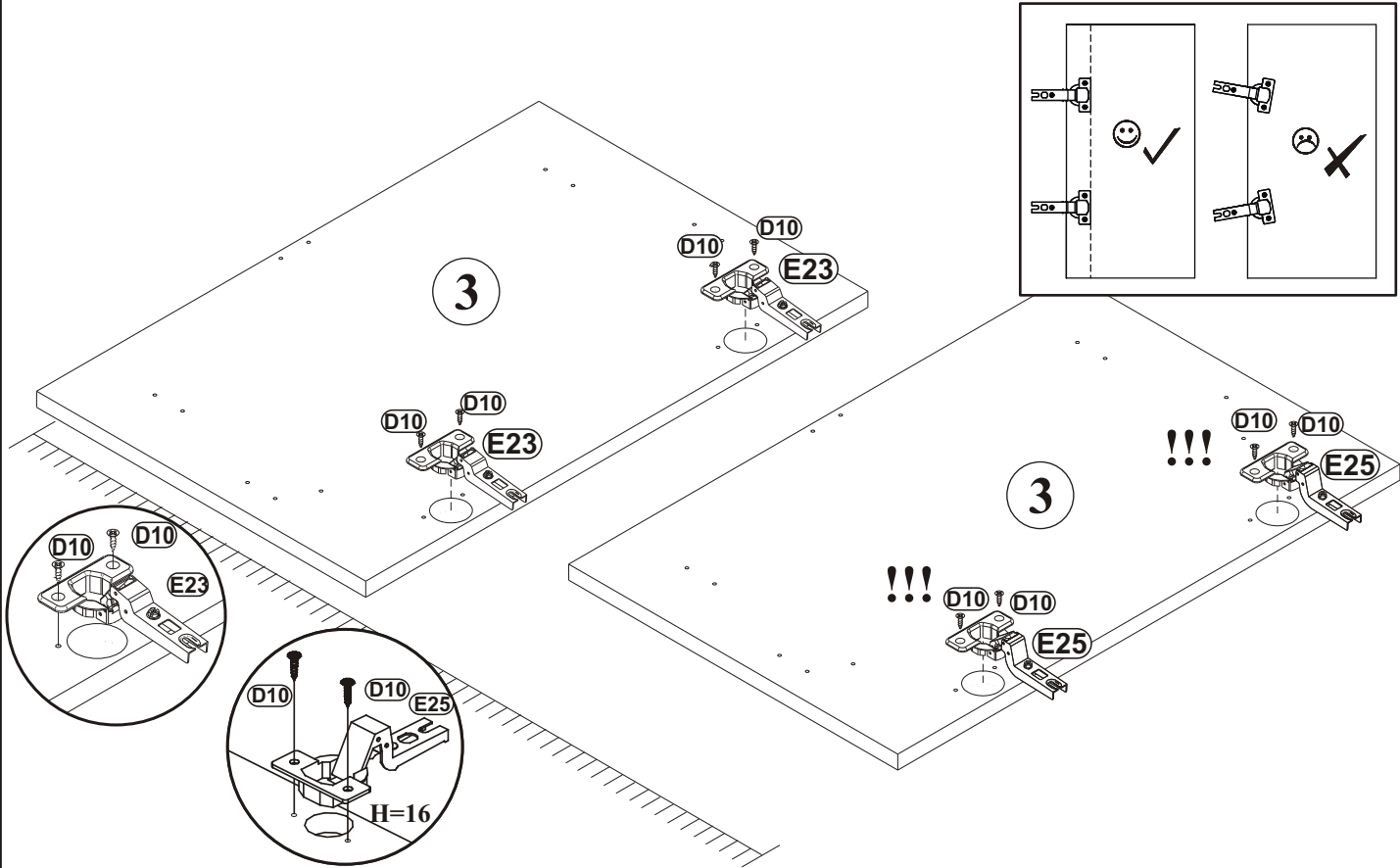

4

UP9	
x12	UPØ3,5x16

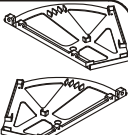
BU2	
x2	

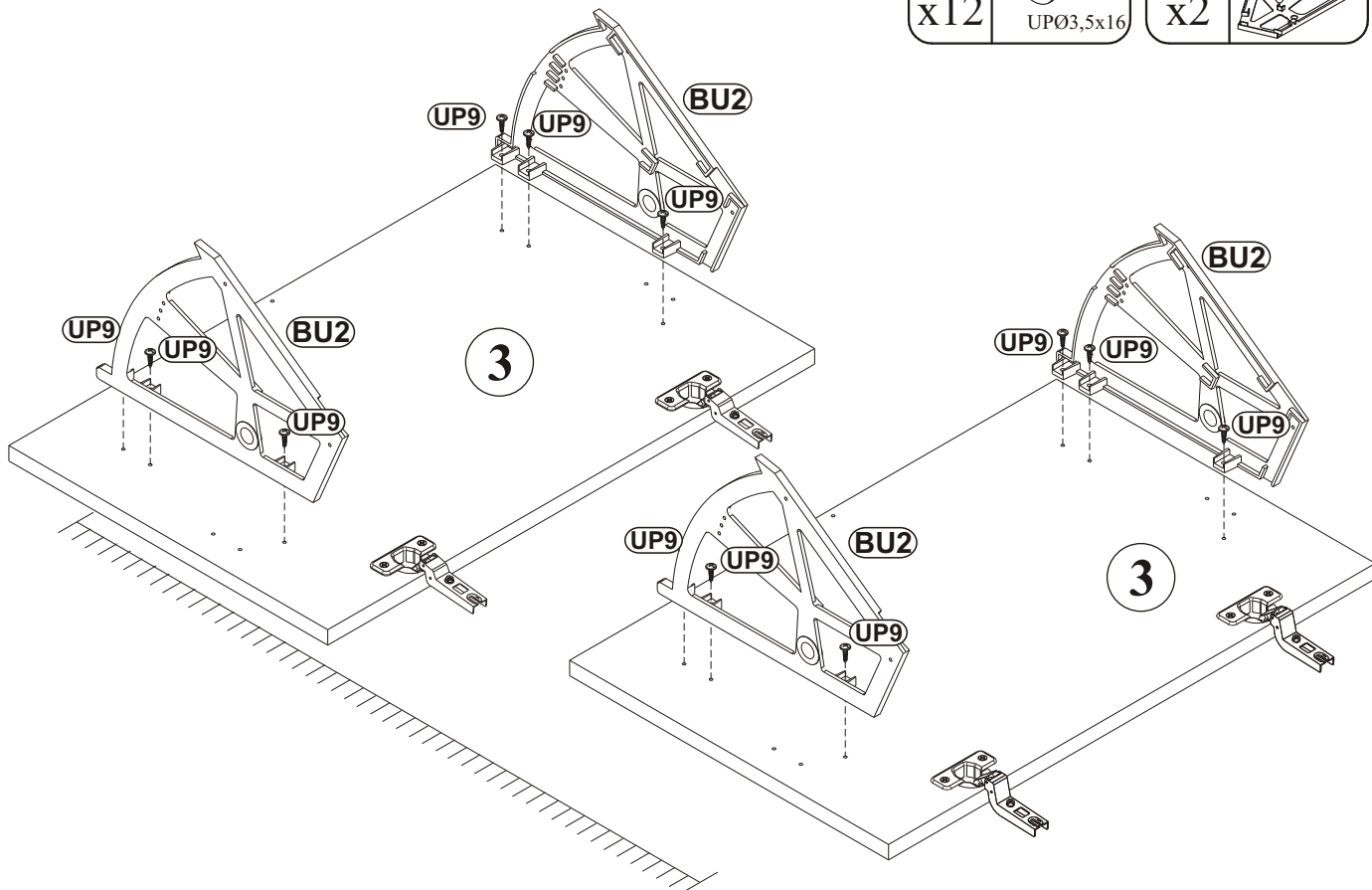

5

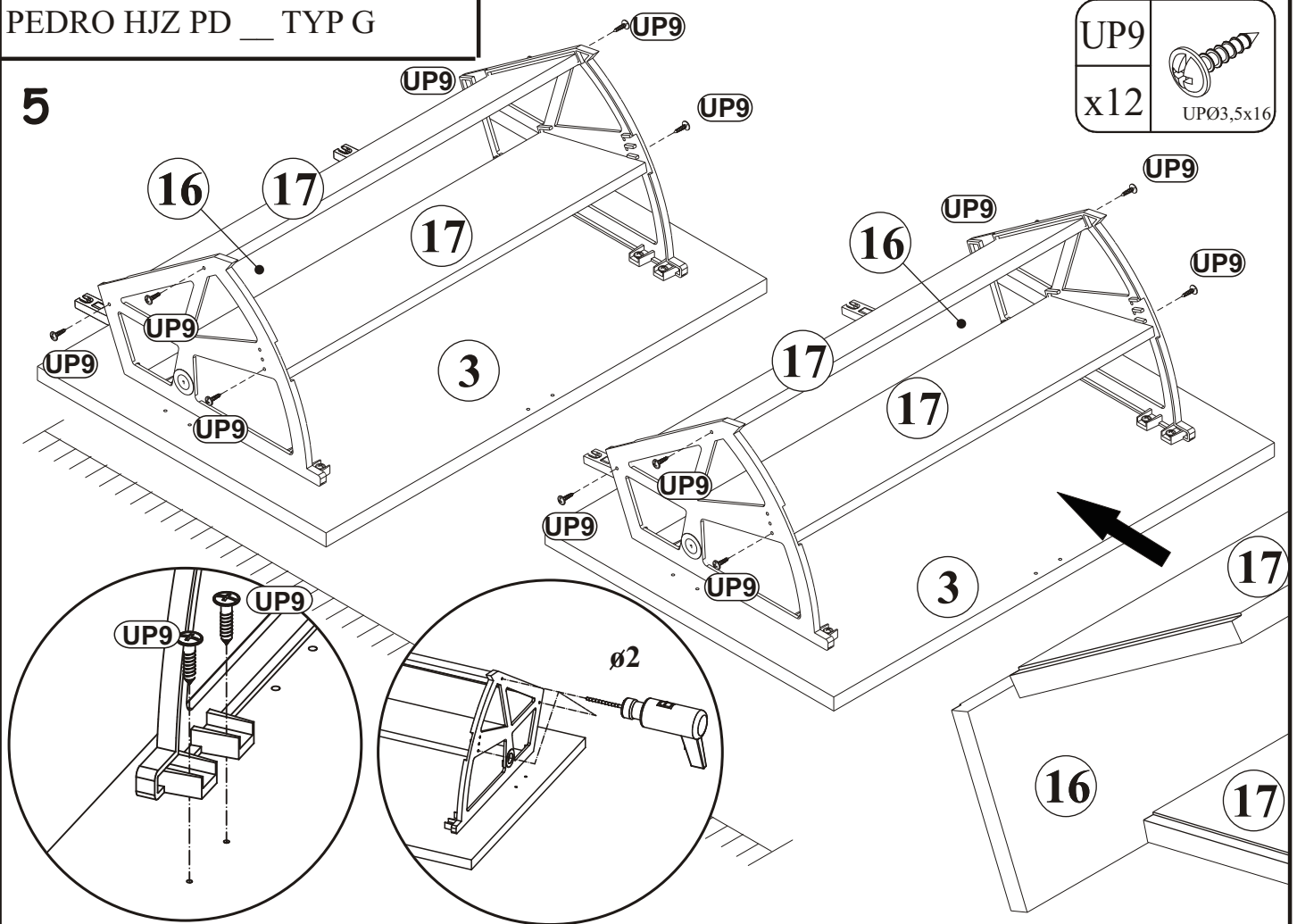





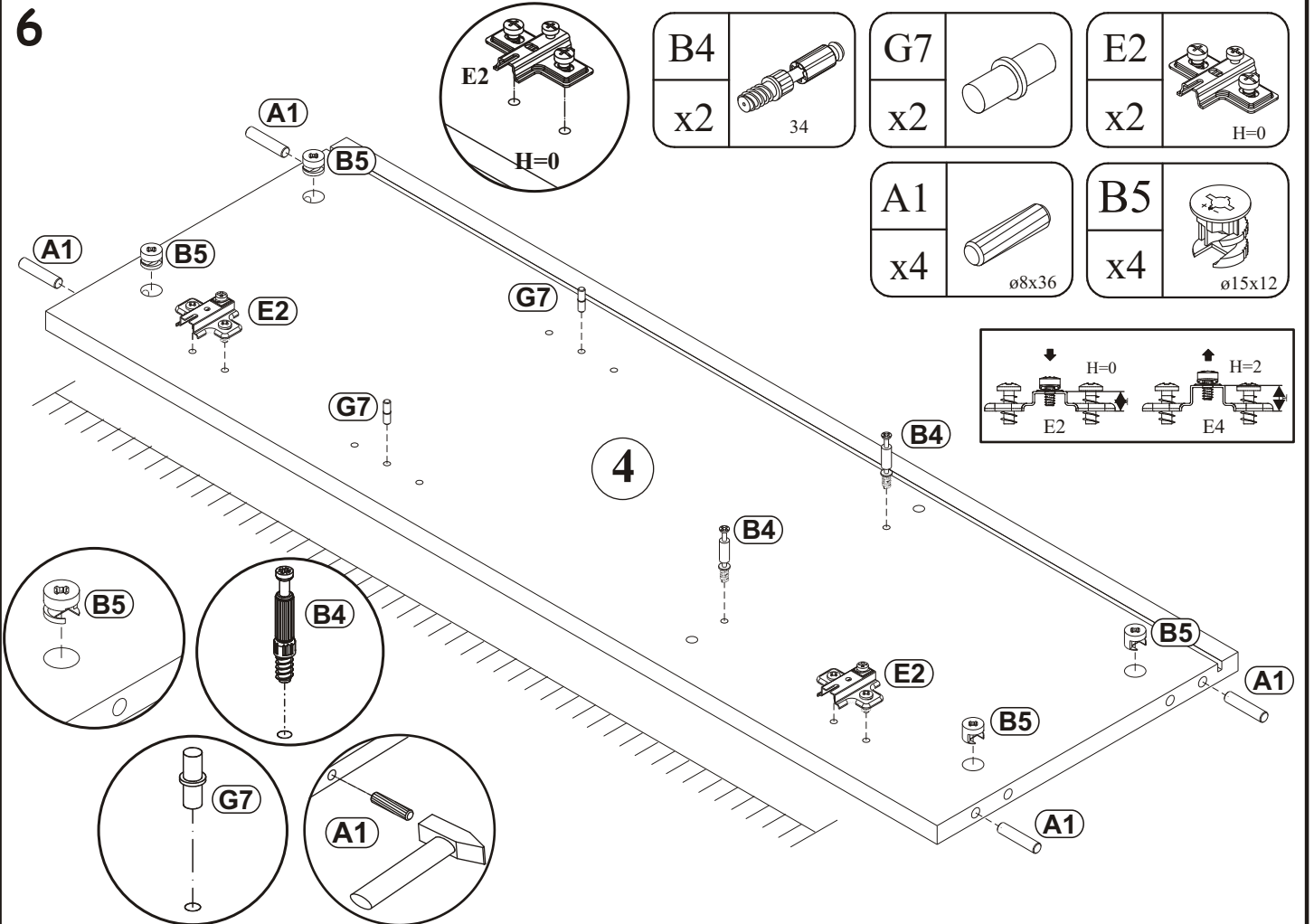

UP9	
x12	UP $\varnothing 3,5 \times 16$

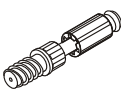
6

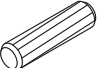
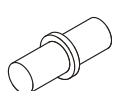

PEDRO HJZ PD \_\_ TYP G

B4		B5		A1	
x4	34	x4	ø15x12	x4	ø8x36
G7		D20		QU1	
x2		x2	ESØ6,3x9,5	x1	L-250mm
		D10			
		x2	USØ3,5x13		

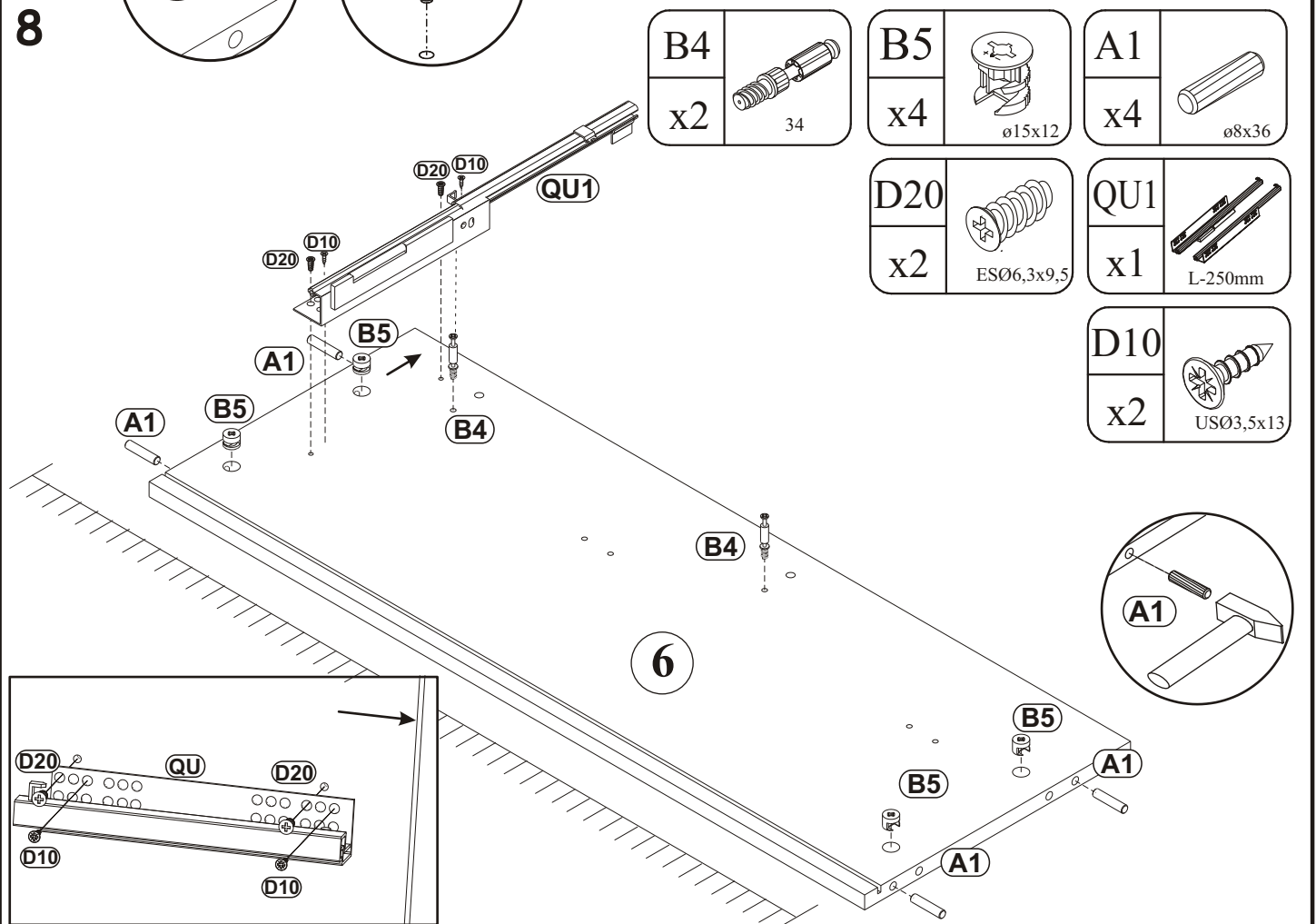
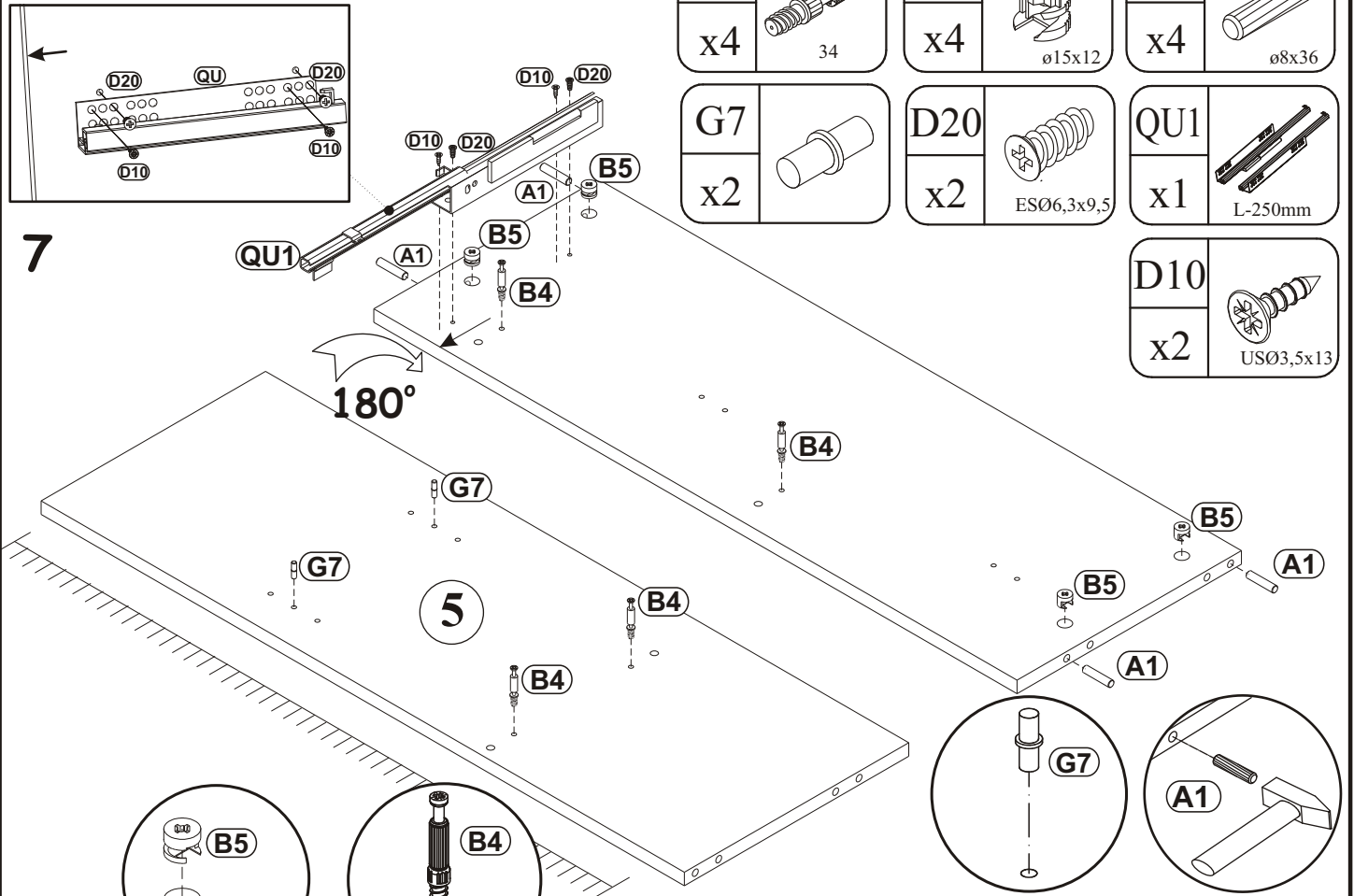



PEDRO HJZ PD \_\_ TYP G

9

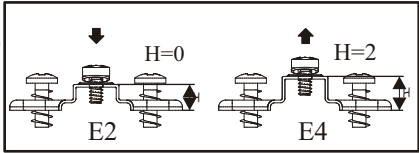

G20	
x1	

B4	
x6	34

E4	
x2	H=2

UP17	
x6	UPØ4x25

ST7	
x6	Ø50, h=25

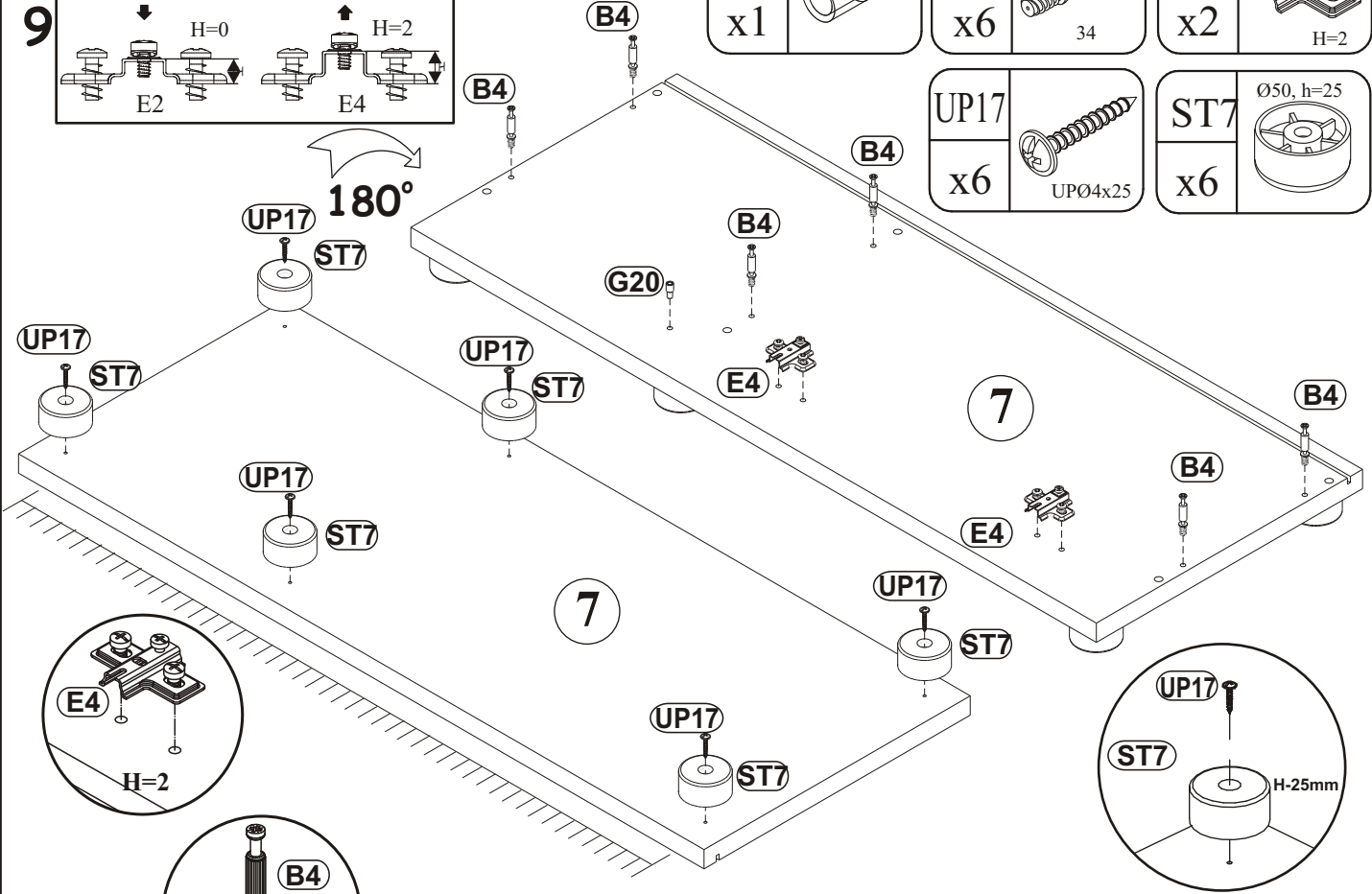

10

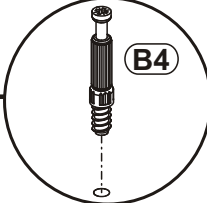

G20	
x1	

B4	
x6	34

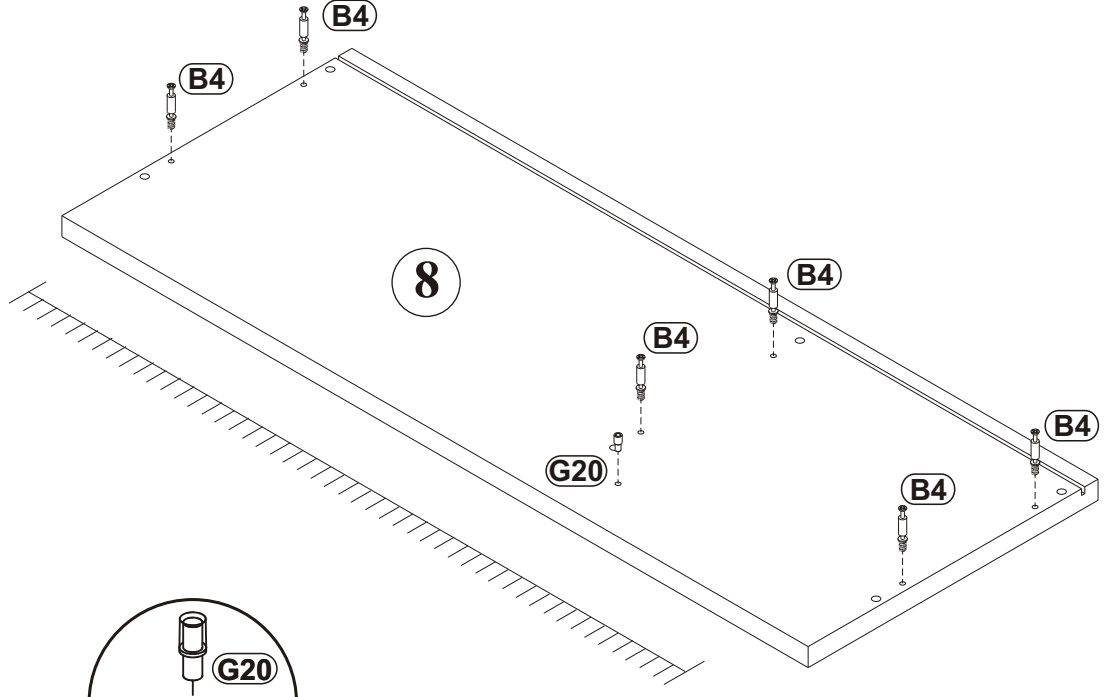

11

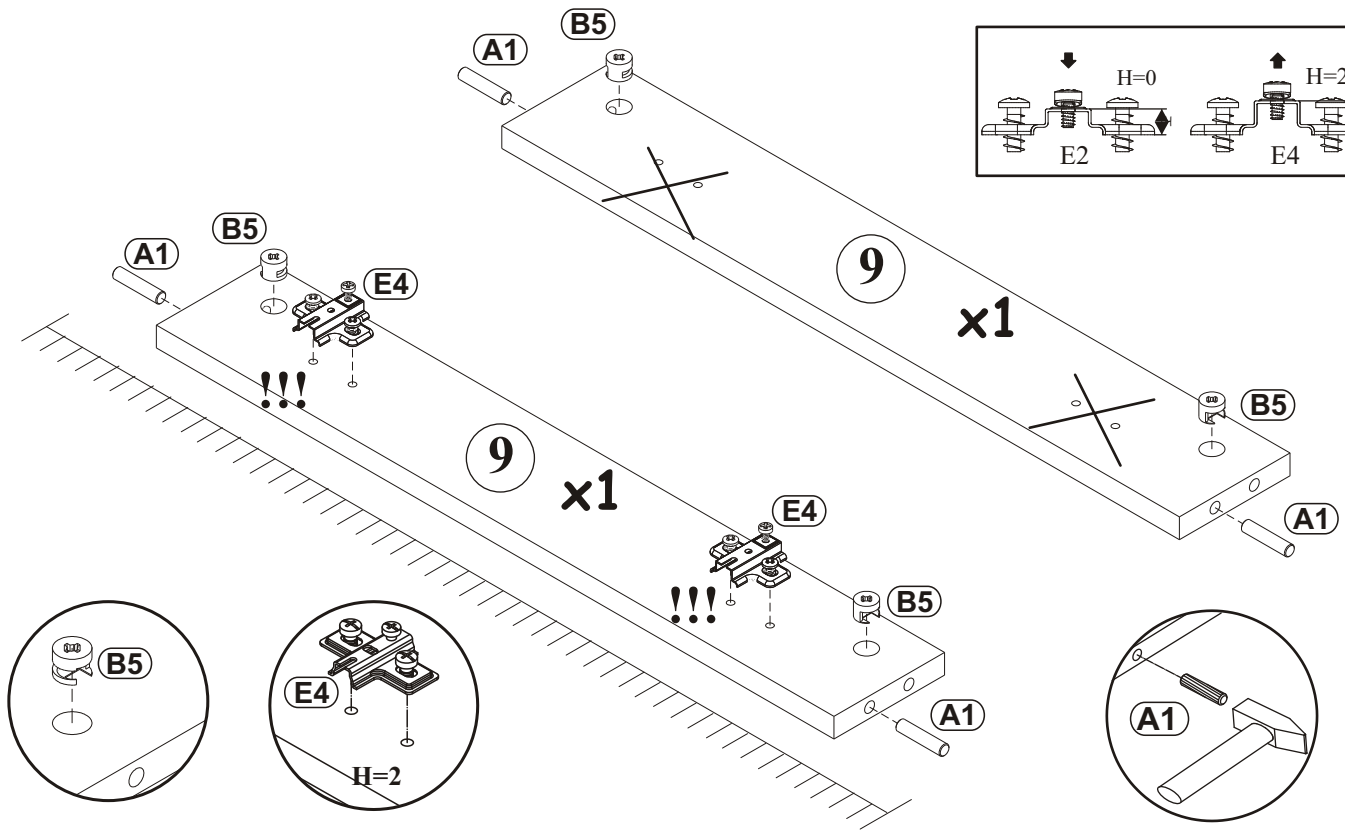
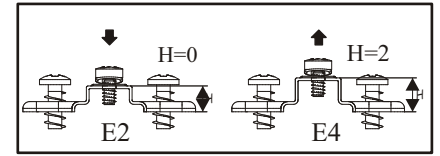
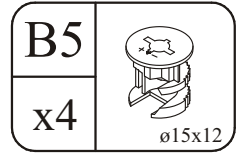
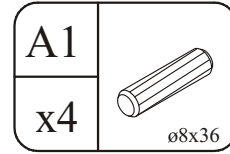
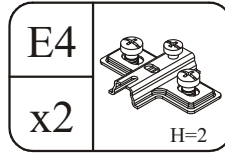

12

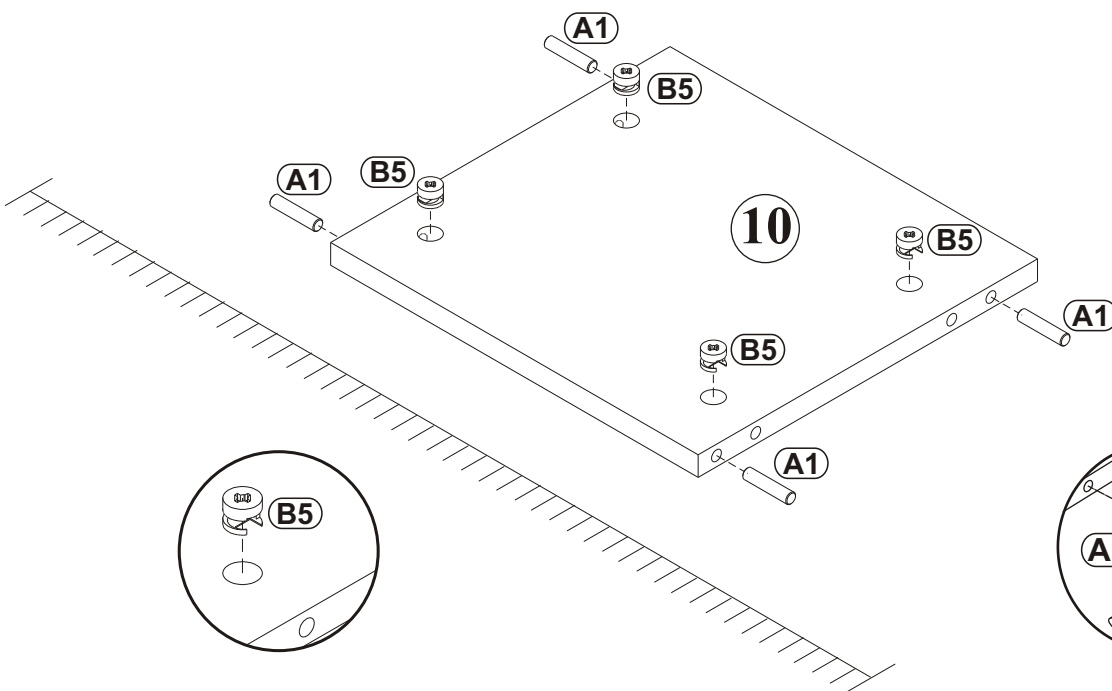
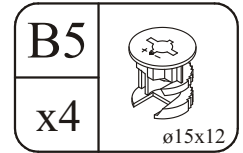
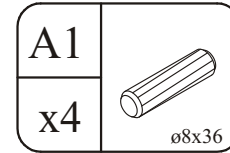

13

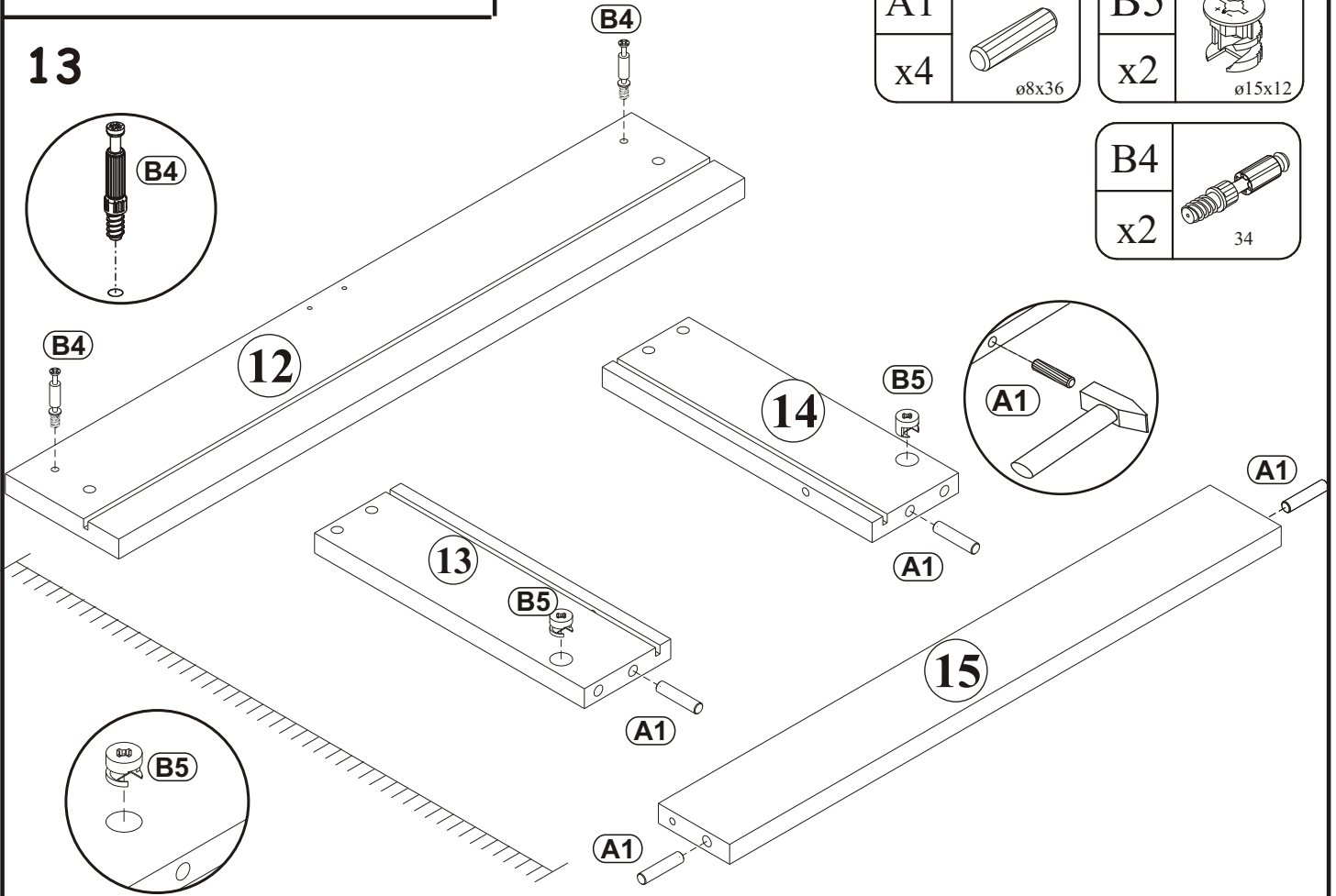

14

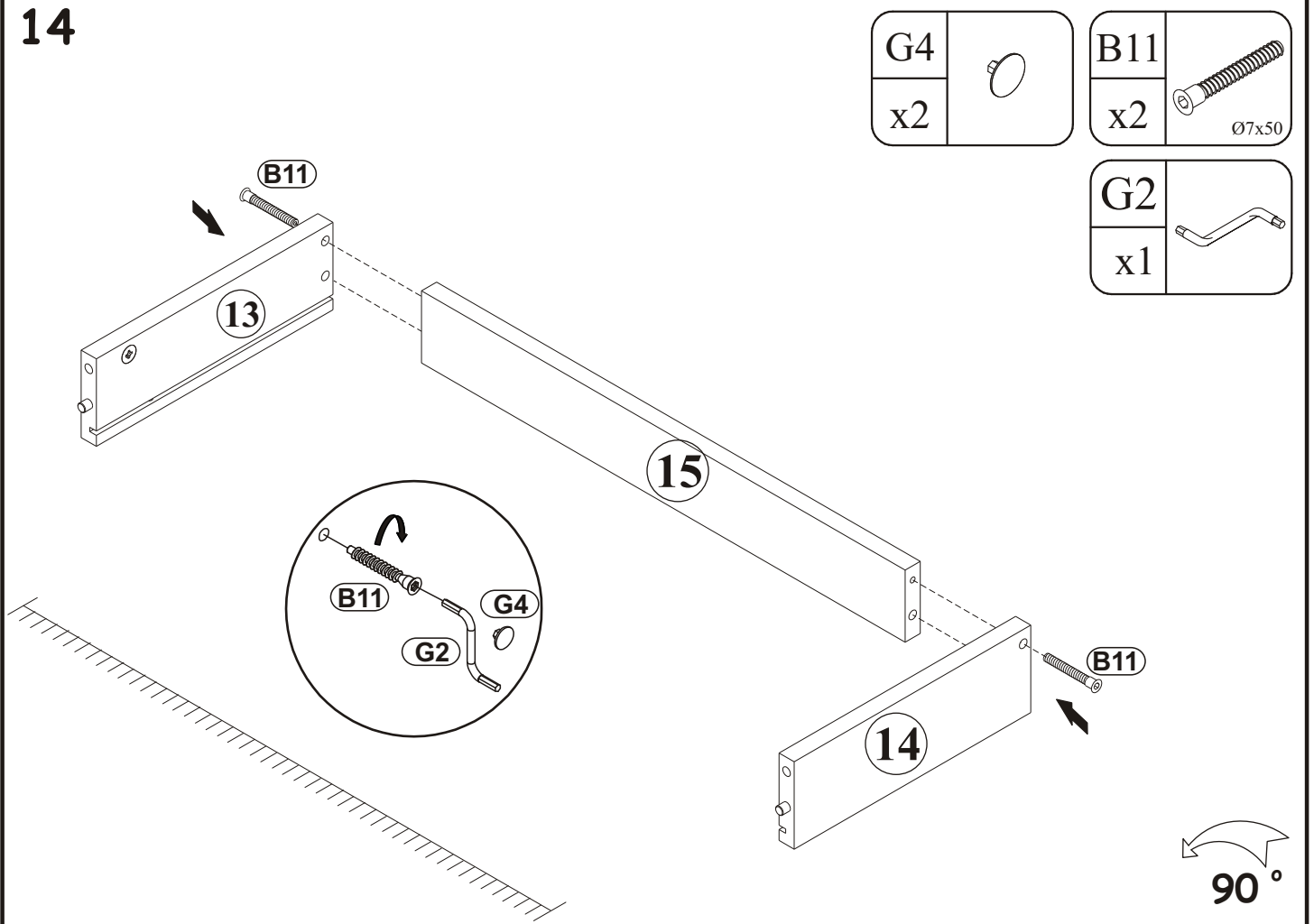

G5		G2	
x2		x1	

15

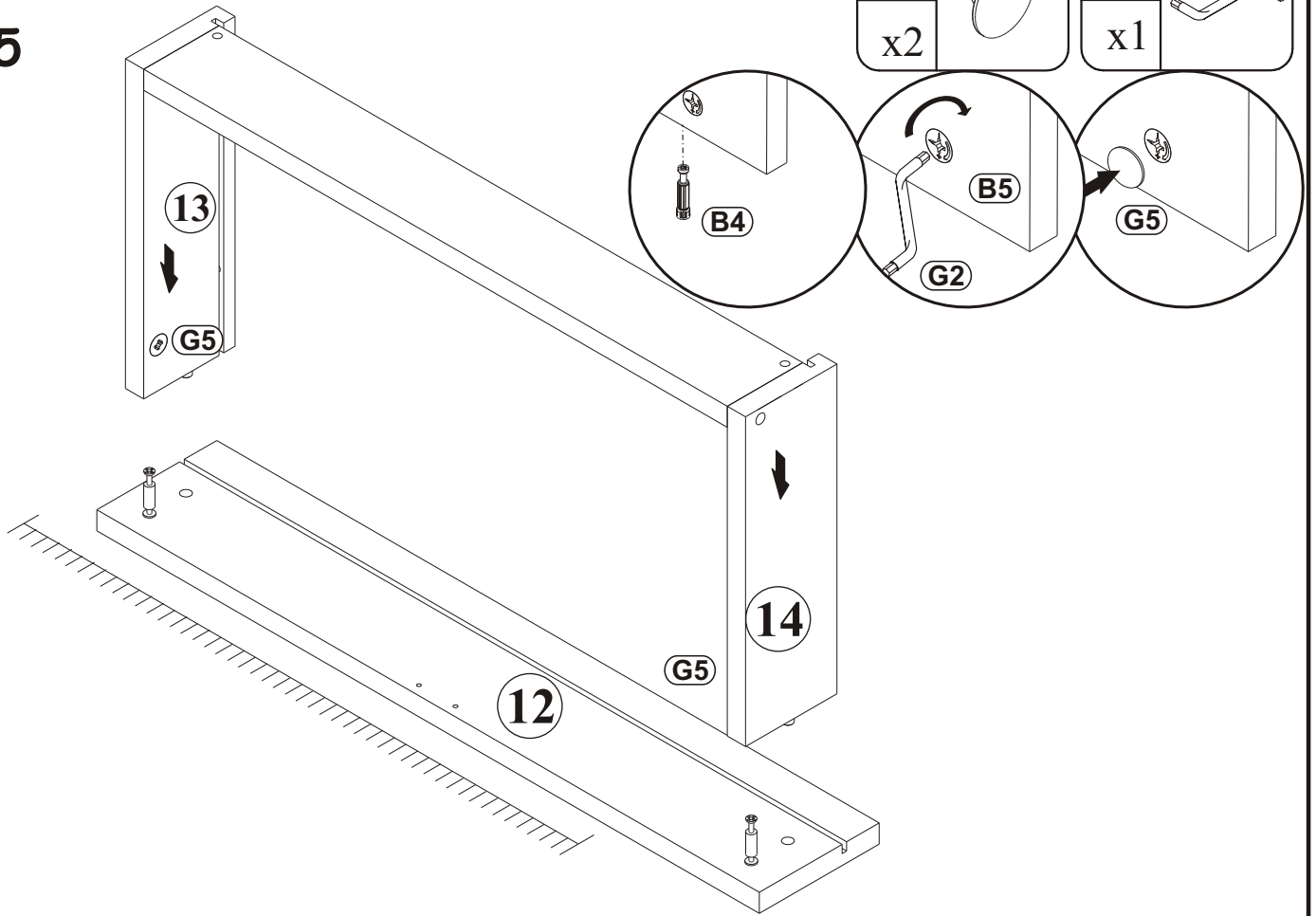

16

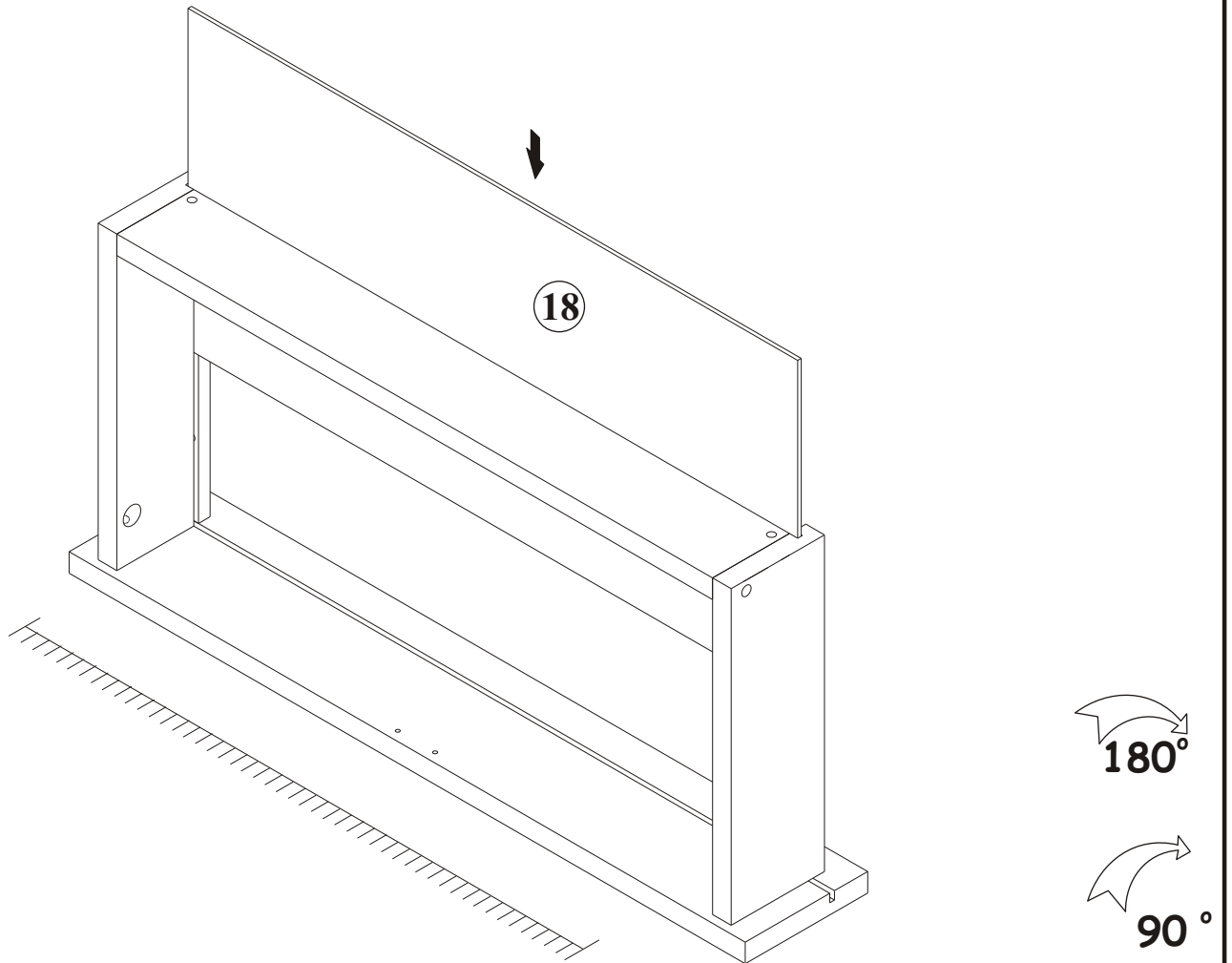

17

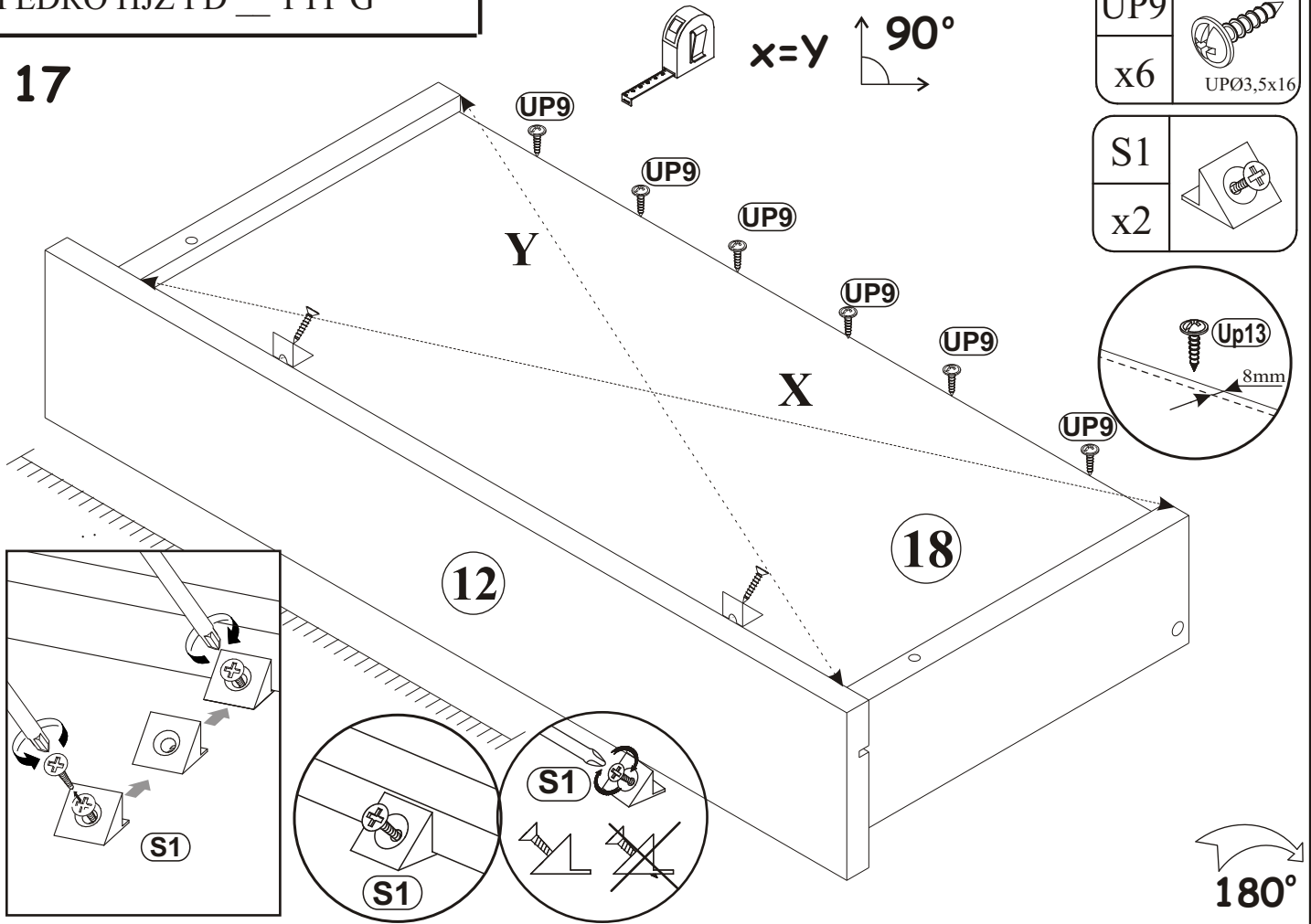

18

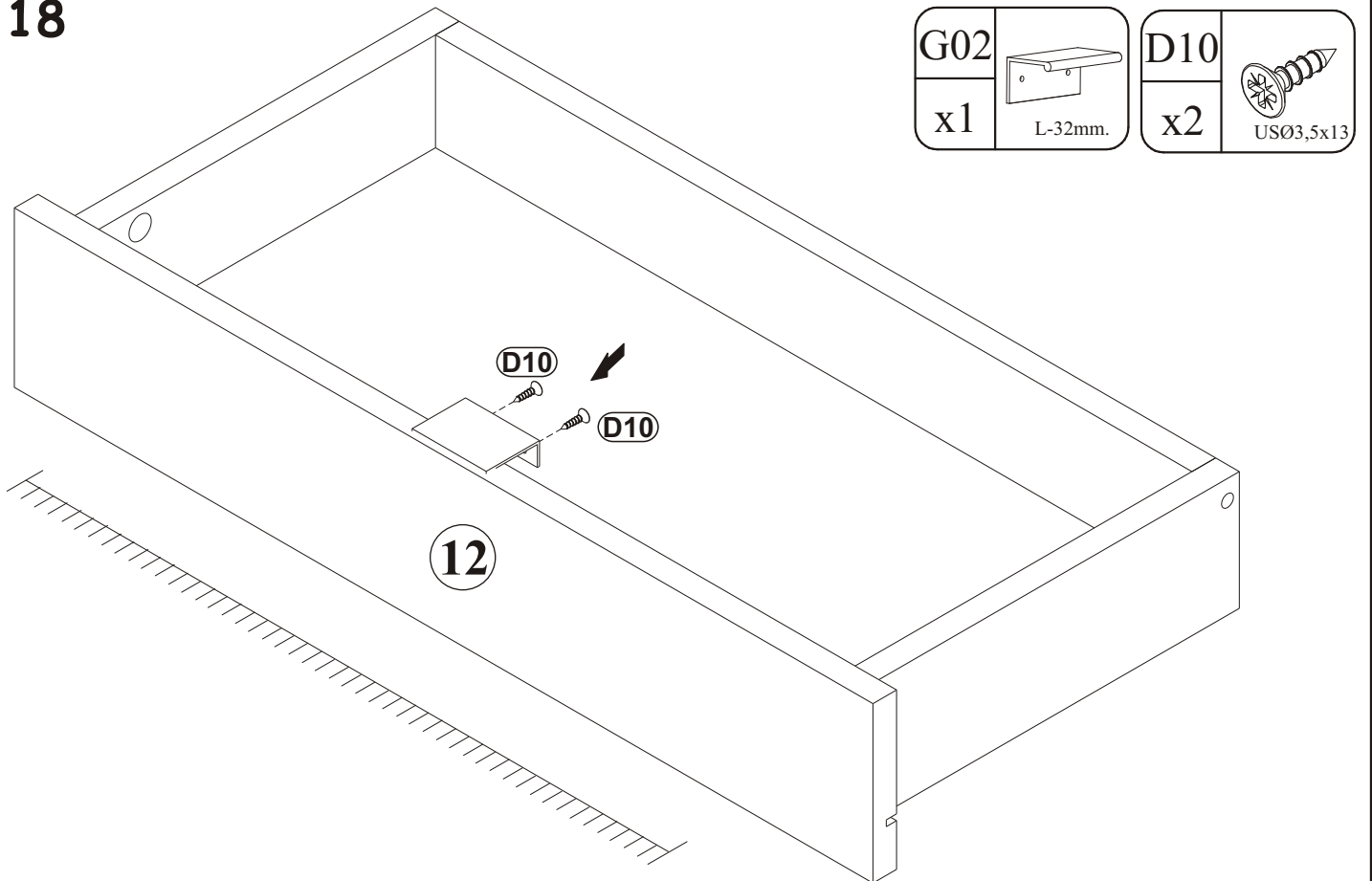

19

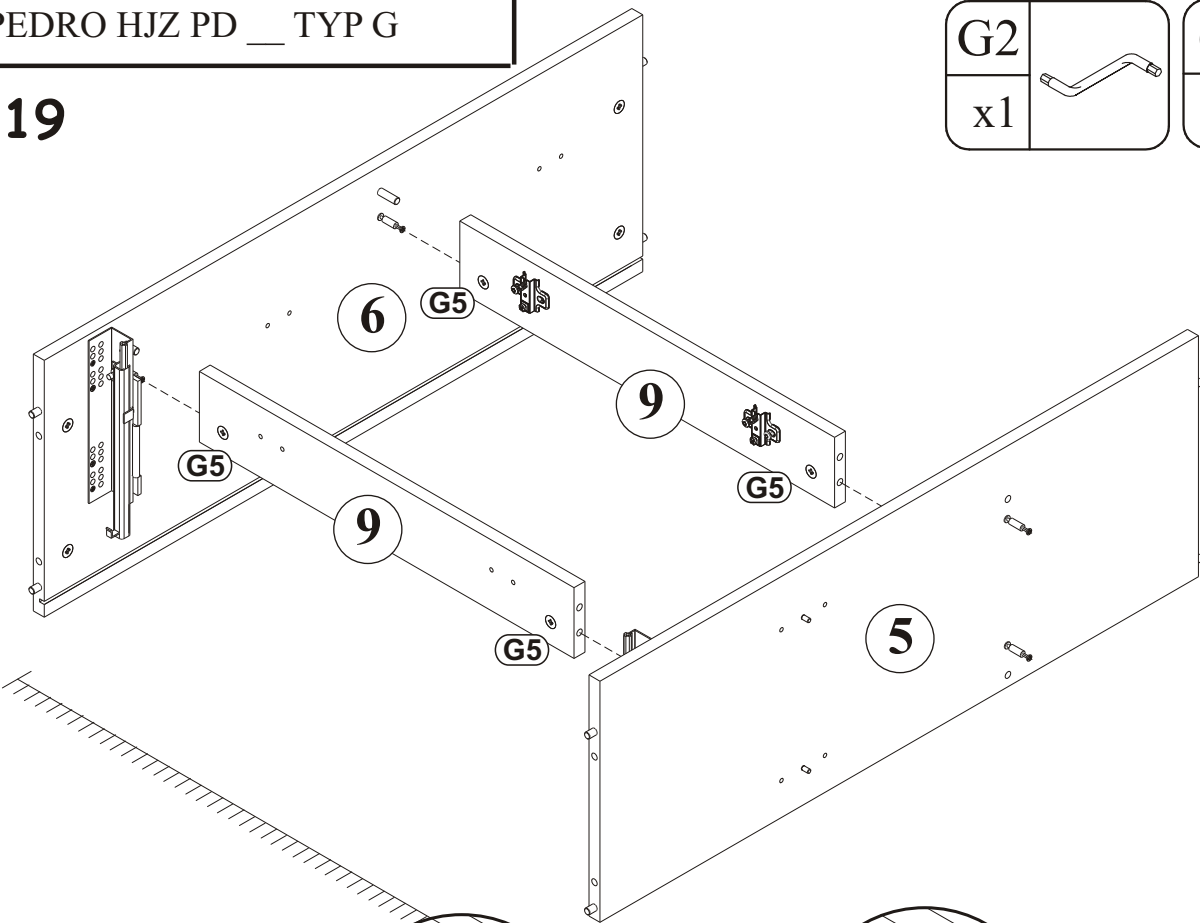

G2	
x1	

G5	
x4	

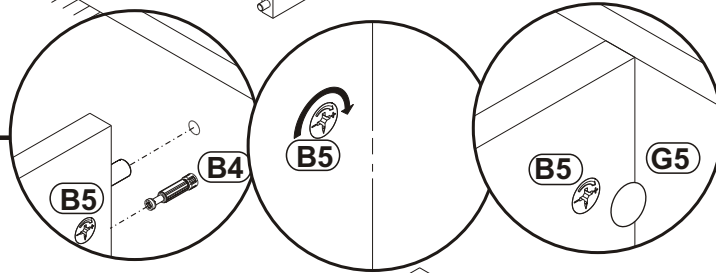

90°

20

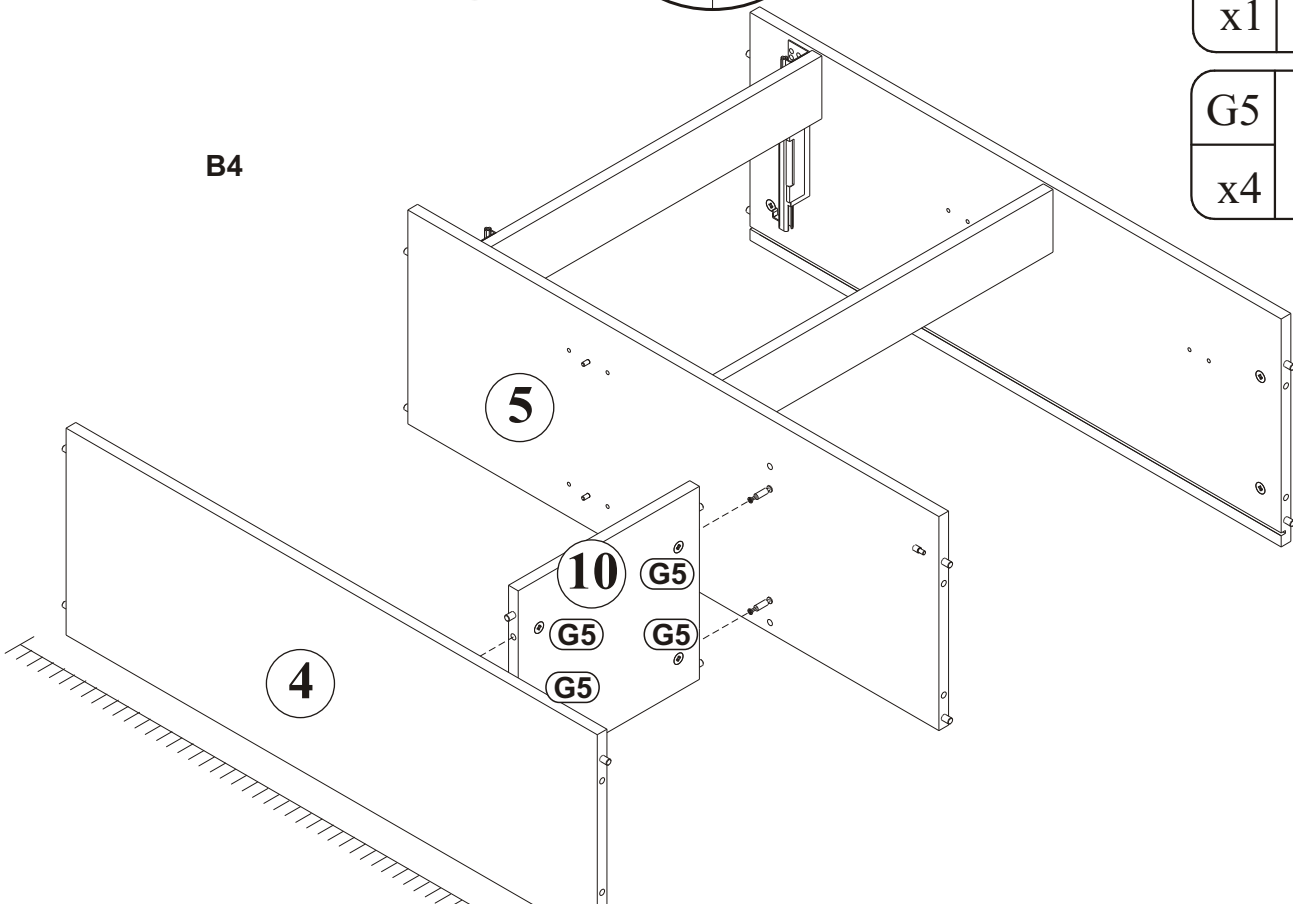

B4

G2	
x1	

G5	
x4	

G2	
x1	

G5	
x6	

21

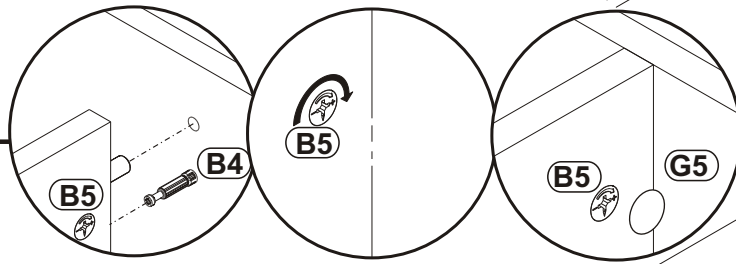
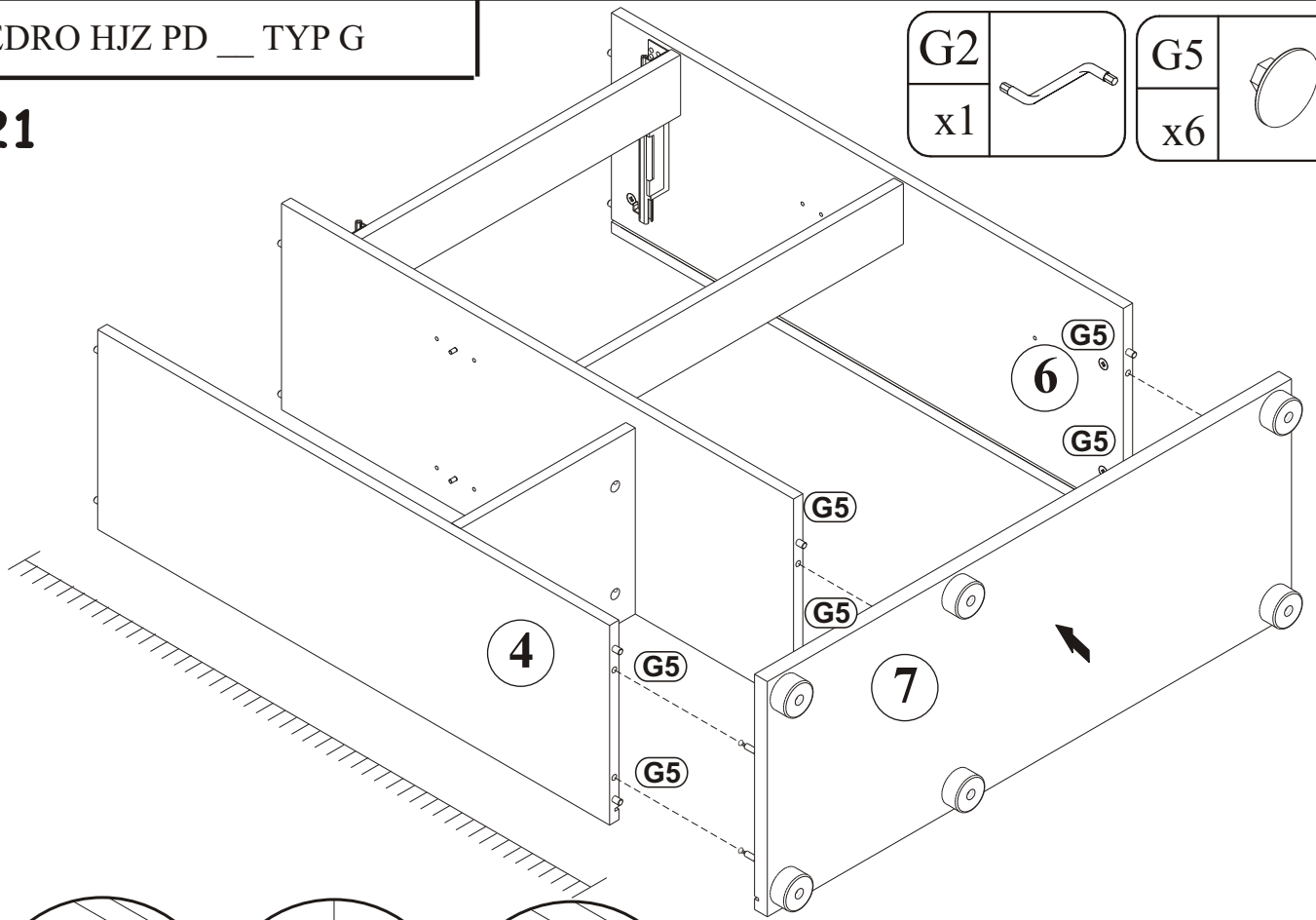

22

G2	
x1	

G5	
x6	

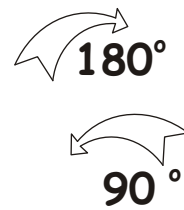
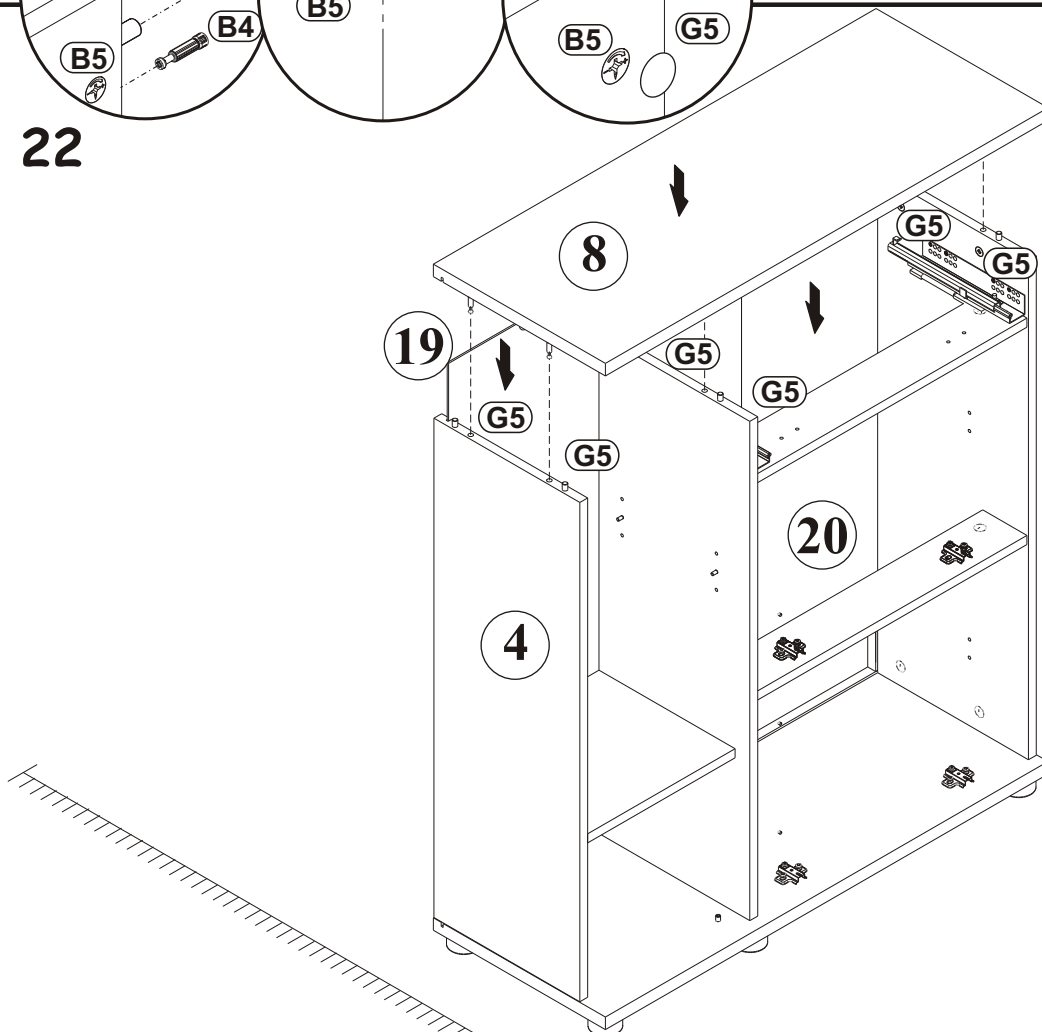

23

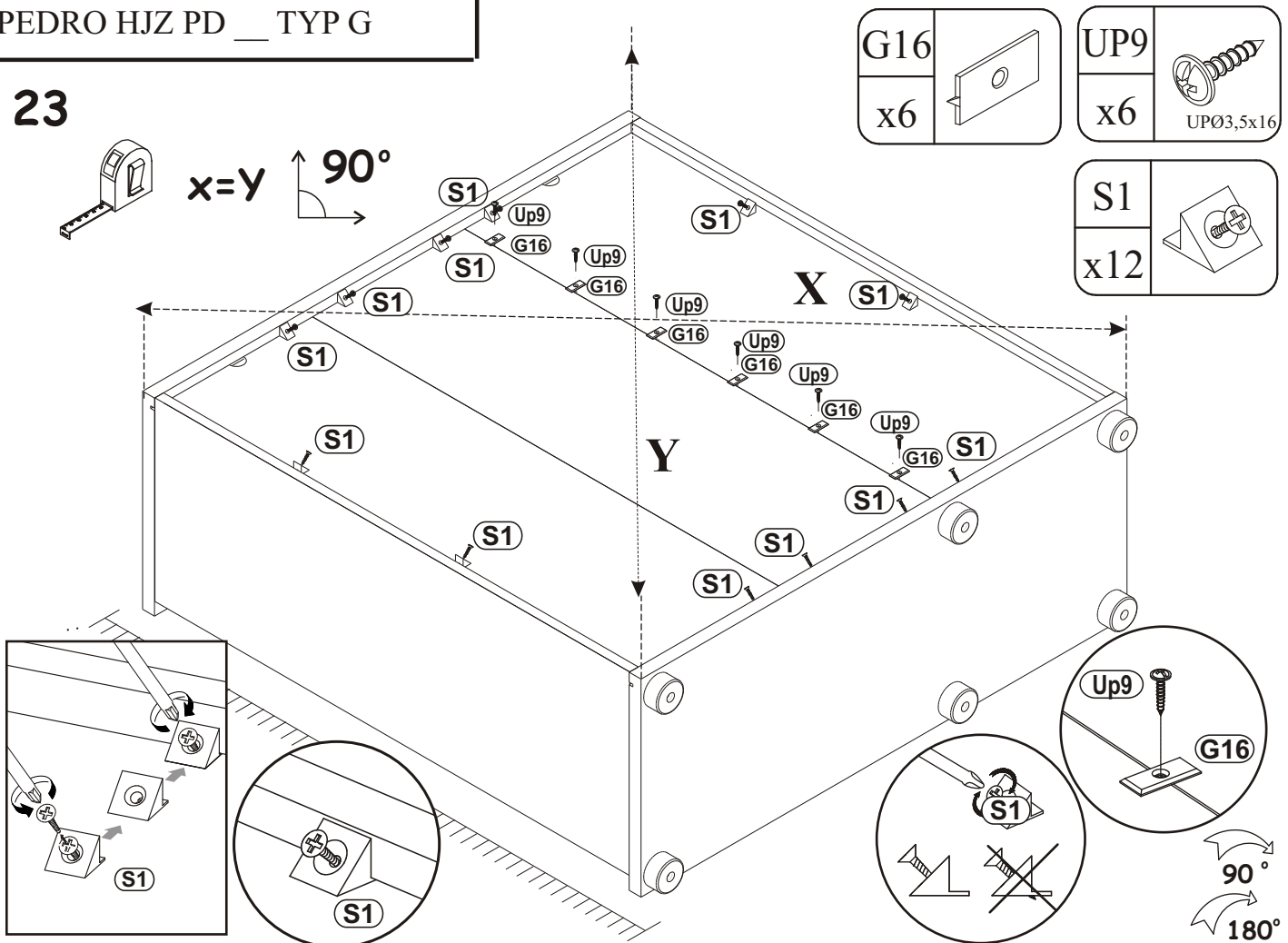

24

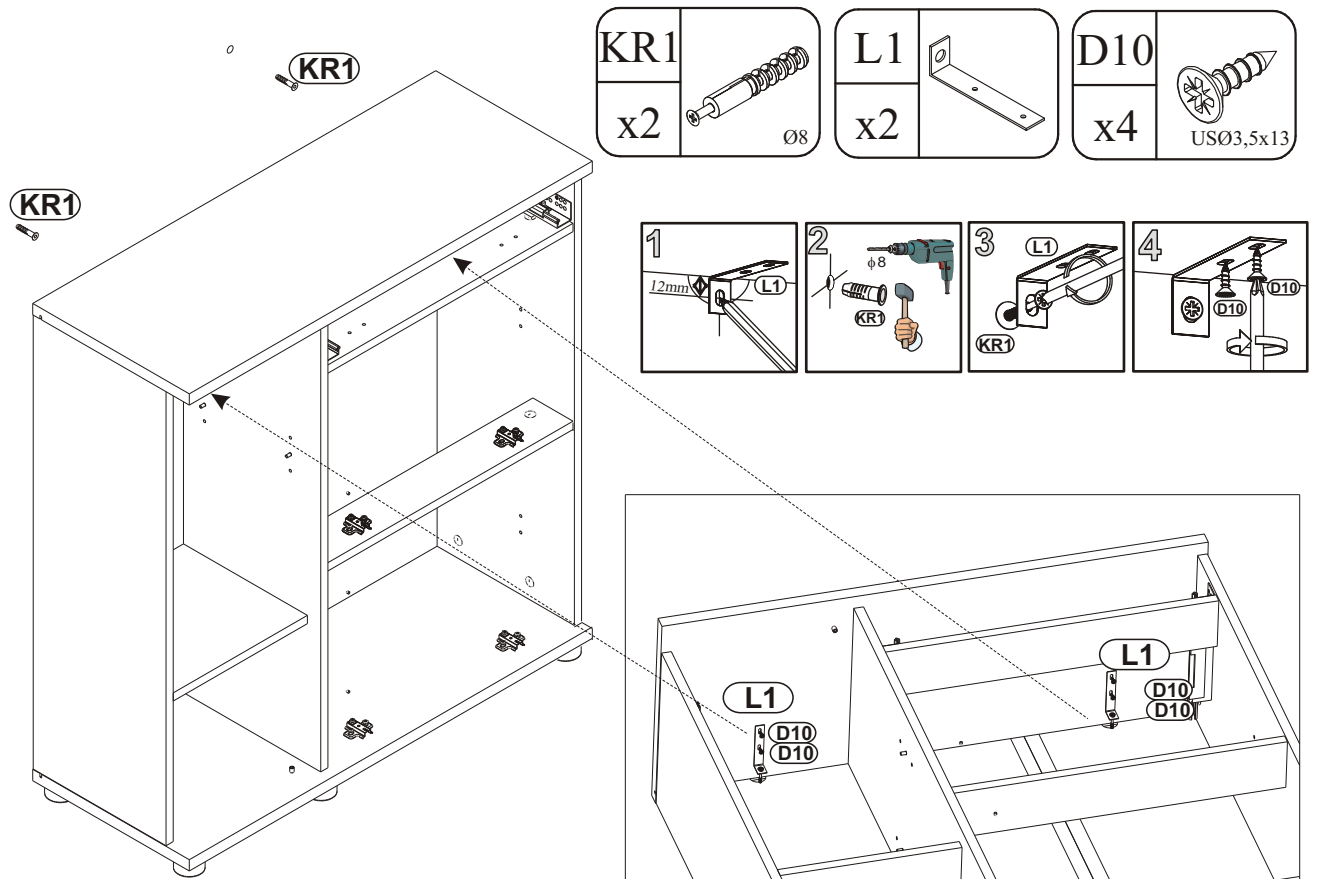





27

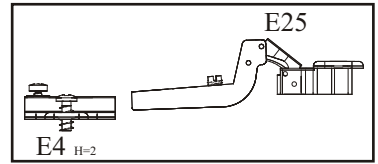
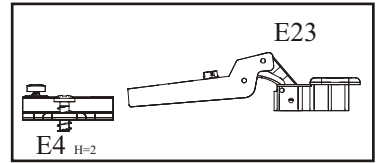
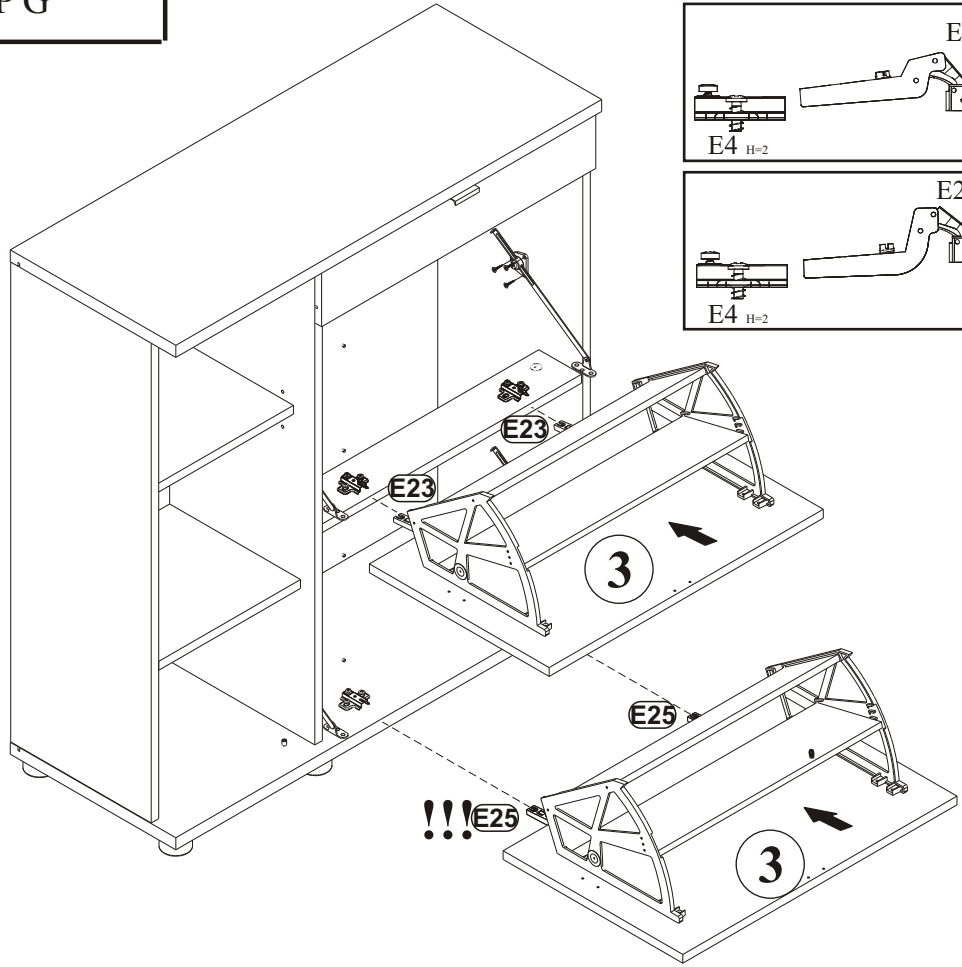
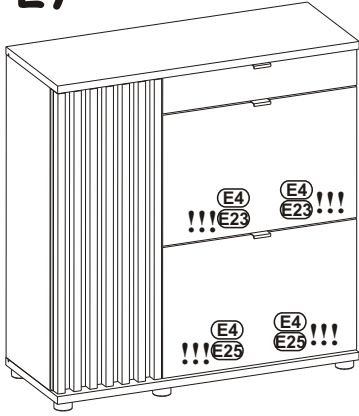

28

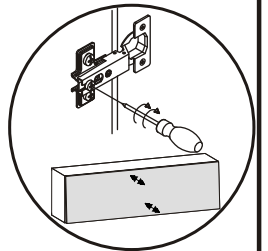
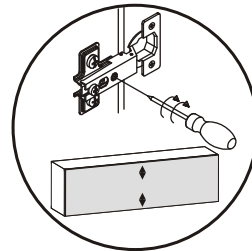
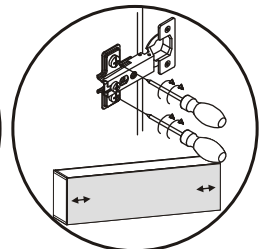
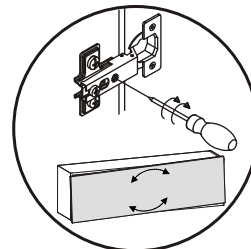
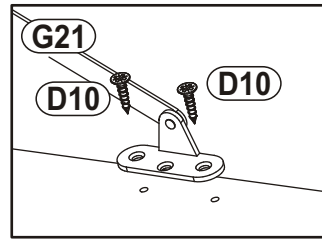
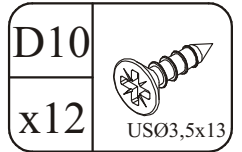
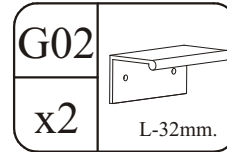
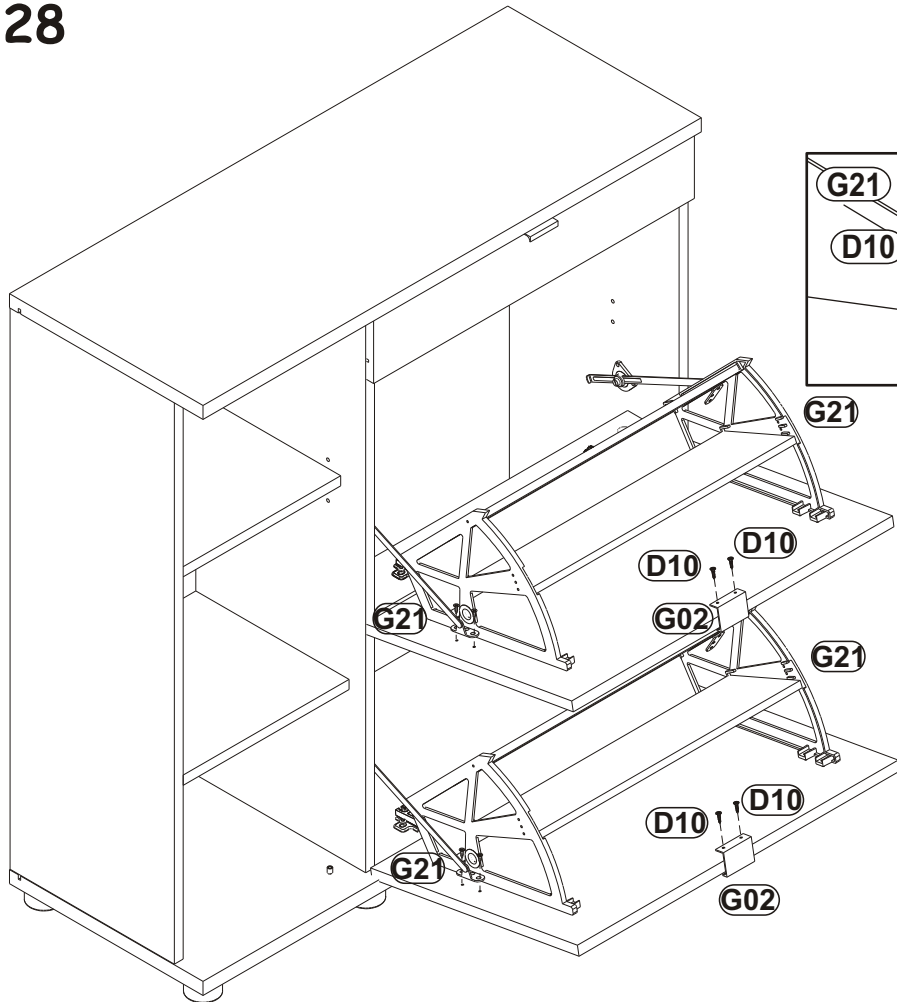

29

