

PEDRO HJZ PD ___ TYP A

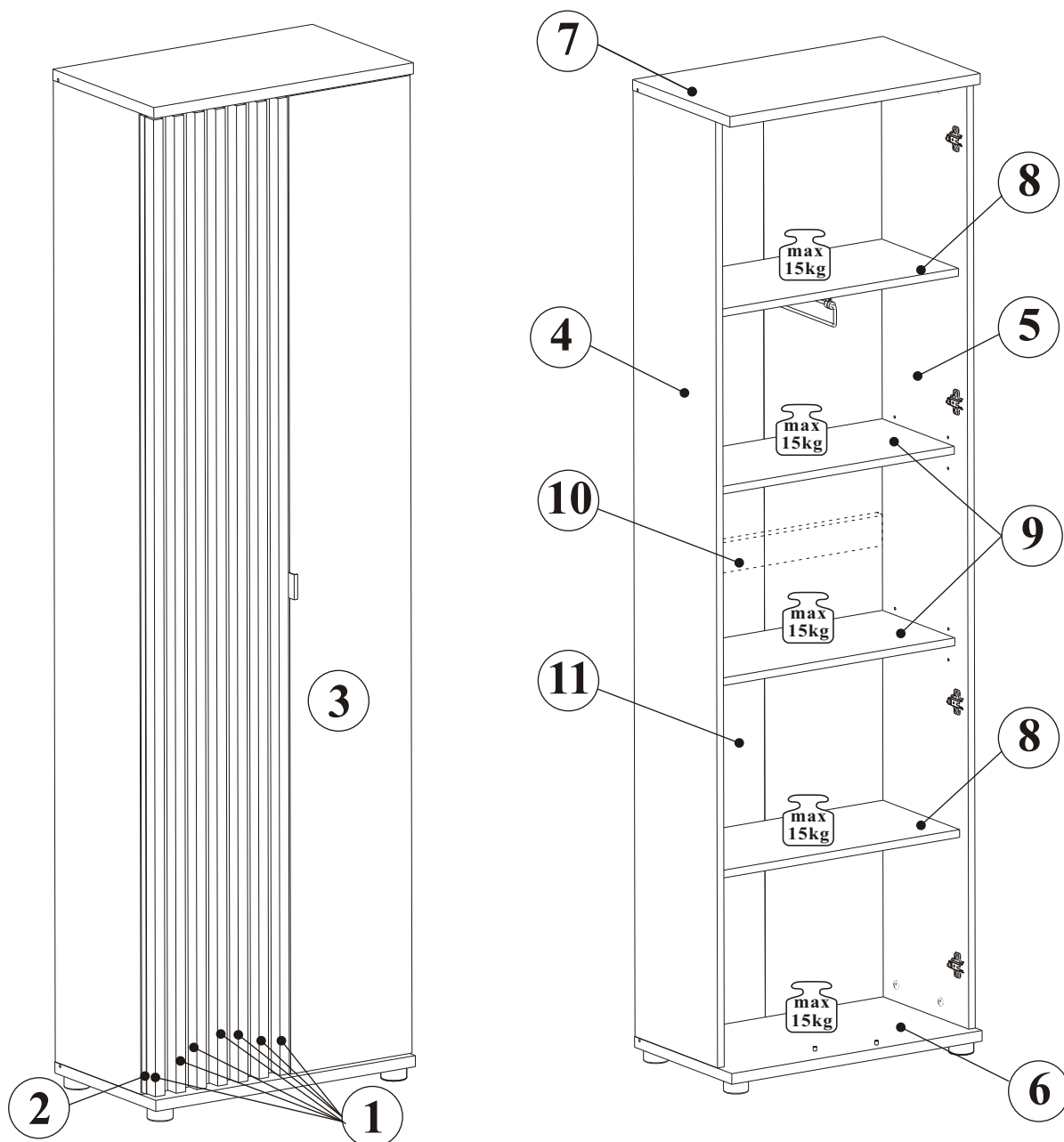

NO	DIM [mm]		COL.-NO	QTY
1	1946	30	22 1/2	7
2	312	1948	16 1/2	1
3	281	1948	16 1/2	1
4	1956	297	16 2/2	1
5	1956	327	16 2/2	1
6	601	350	22 2/2	1
7	601	350	22 2/2	1
8	567	276	16 2/2	2
9	567	260	16 2/2	2
10	567	60	16 2/2	1
11	1967	578	3 1/2	1

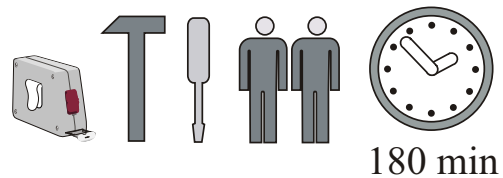



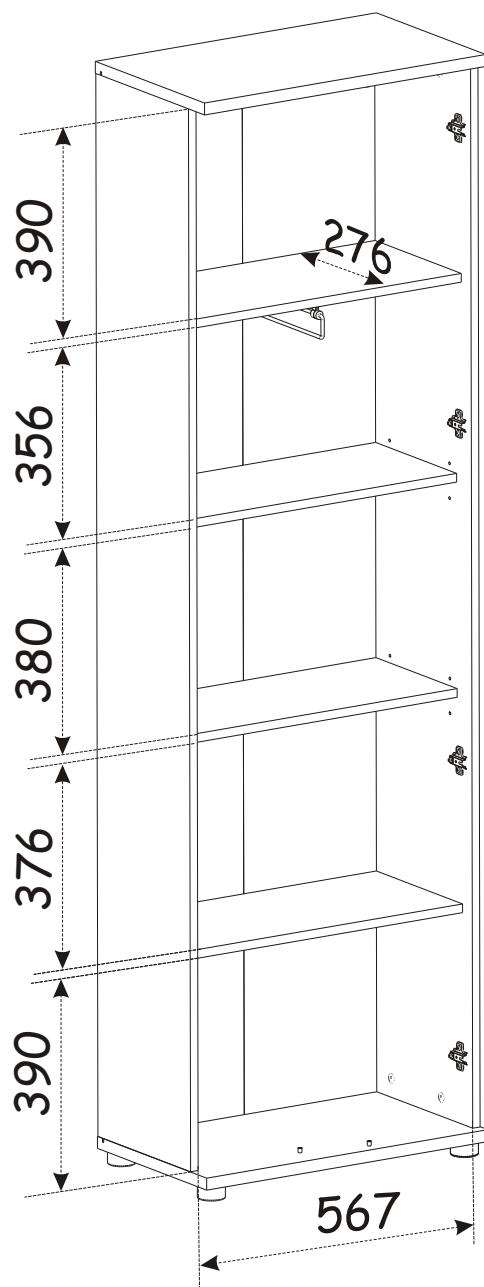
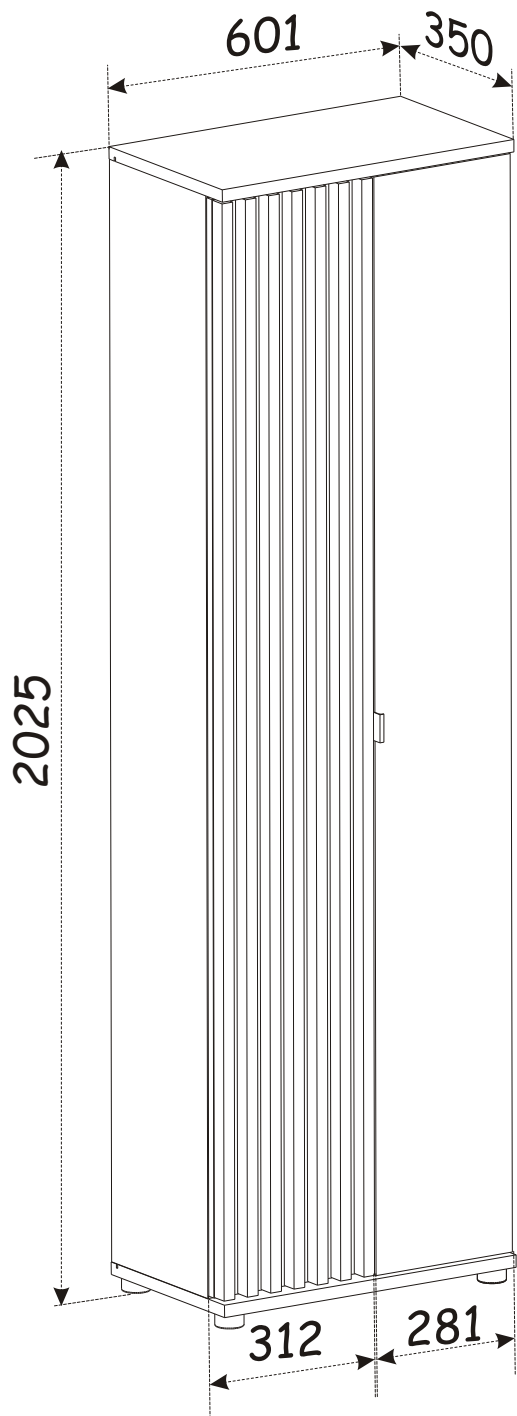

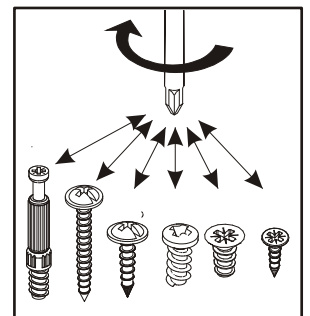
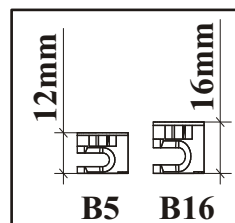
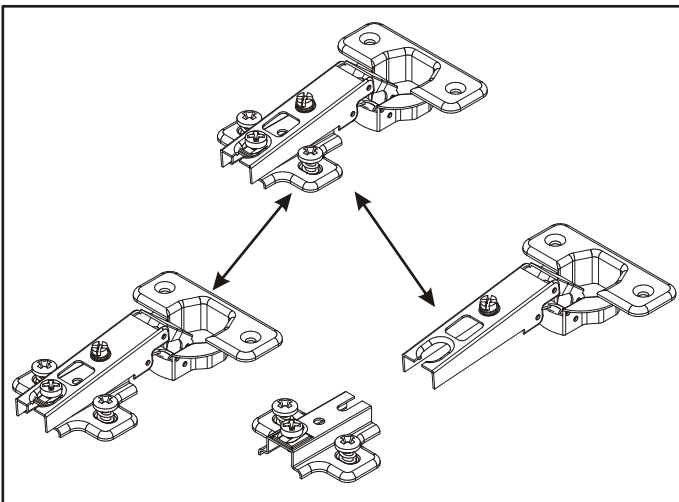
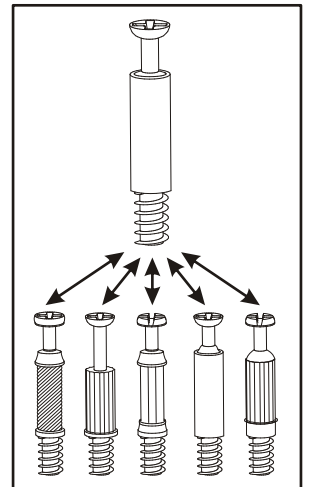
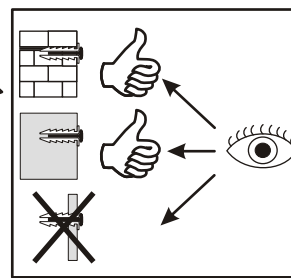
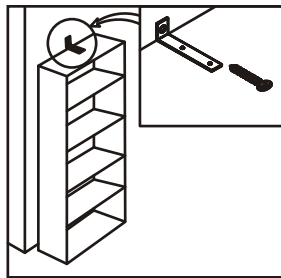
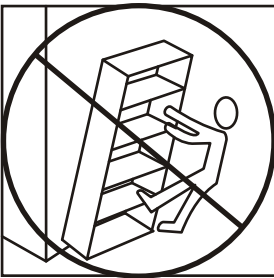
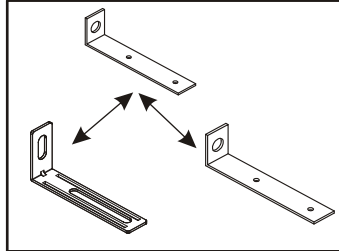
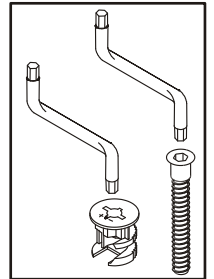
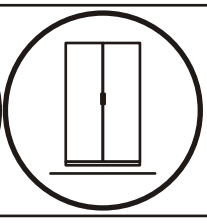
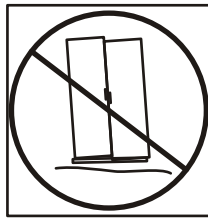
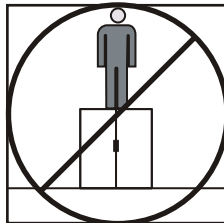
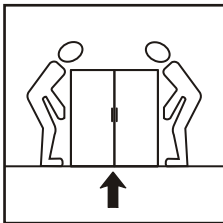
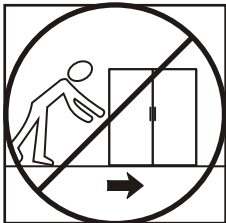
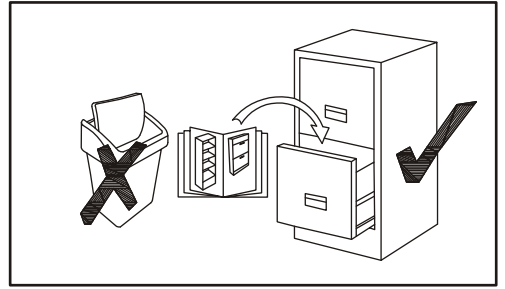
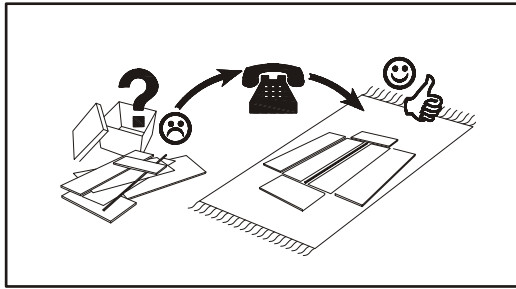
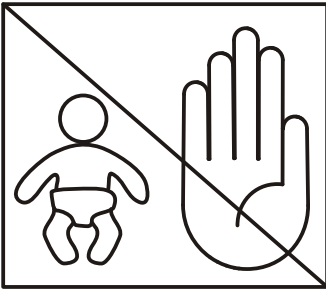
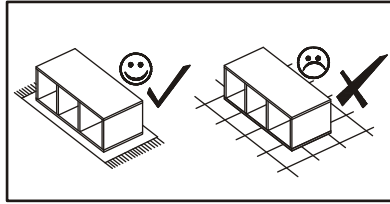
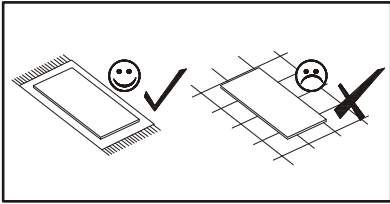



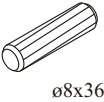

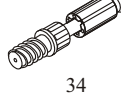
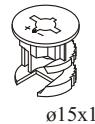
PEDRO HJZ PD _ TYP A

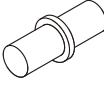
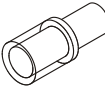
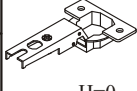
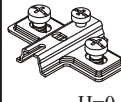
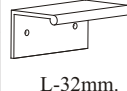

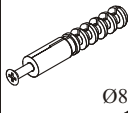
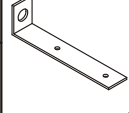
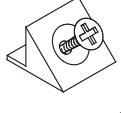
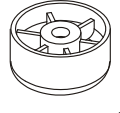
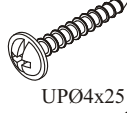

PEDRO HJZ PD _ TYP A

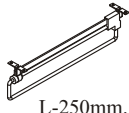
A1 x20  ø8x36	B22 x35  Ø7x40	G4 x30 	B4 x16  34	B5 x16  ø15x12	G5 x16 
G7 x8 	G20 x4 	E21 x8  Ø35 H=0	E2 x8  H=0	G02 x1  L-32mm.	G12 x5  Ø14
KR1 x2  Ø8	L1 x2 	S1 x16 	ST7 x4  Ø50, h=25	UP17 x4  UPØ4x25	D10 x22  USØ3,5x13
UP9 x16  UPØ3,5x16	G2 x1 	C6 x1  L-250mm.			

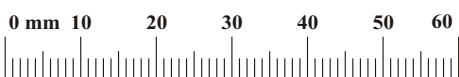

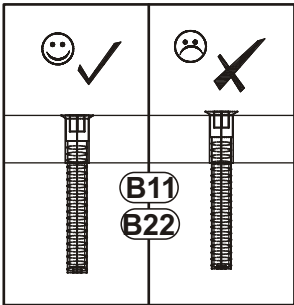
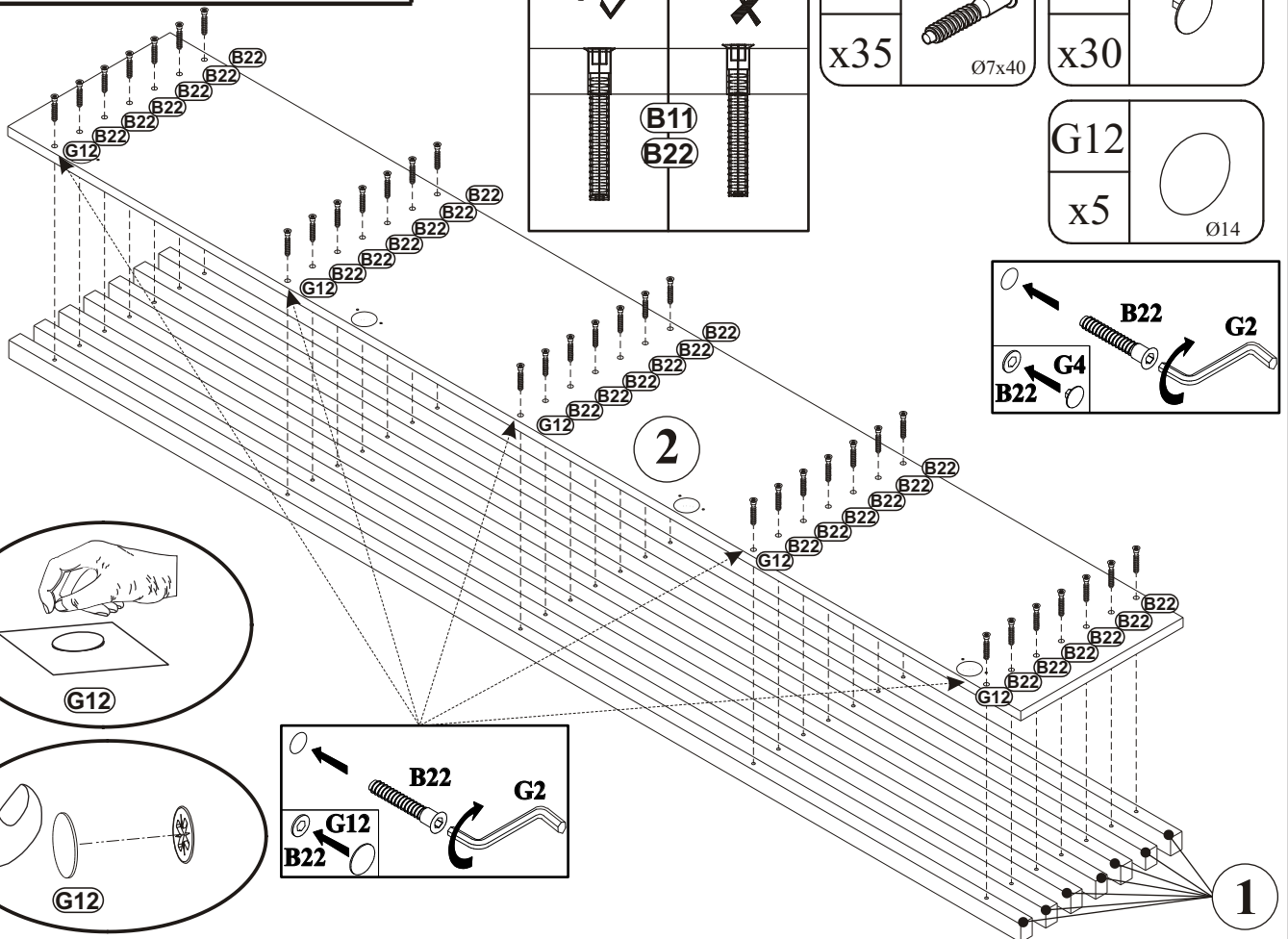

PEDRO HJZ PD _ TYP A

1



B22	
x35	Ø7x40

G4	
x30	

G12	
x5	Ø14

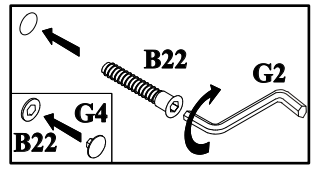

2

2

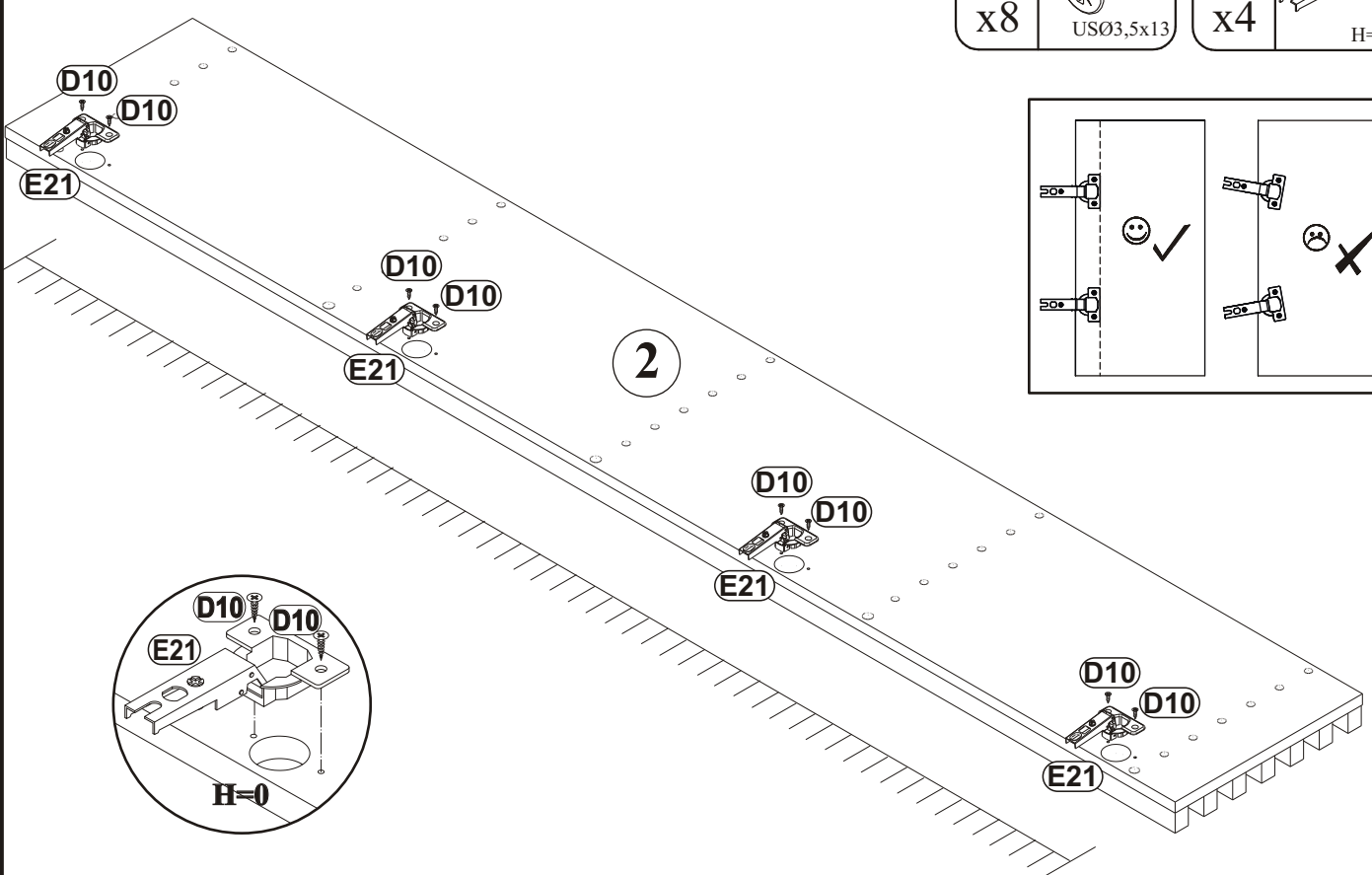

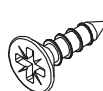
D10	
x8	USØ3,5x13

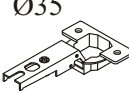
E21	
x4	Ø35 H=0

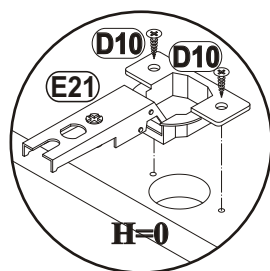
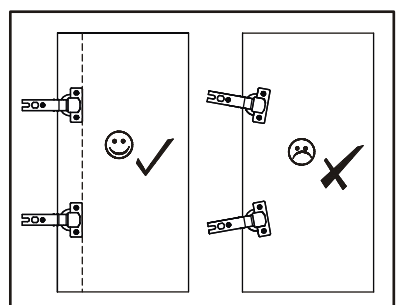

D10	
x10	USØ3,5x13

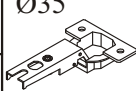
E21	
x4	Ø35 H=0

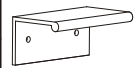
G02	
x1	L-32mm.

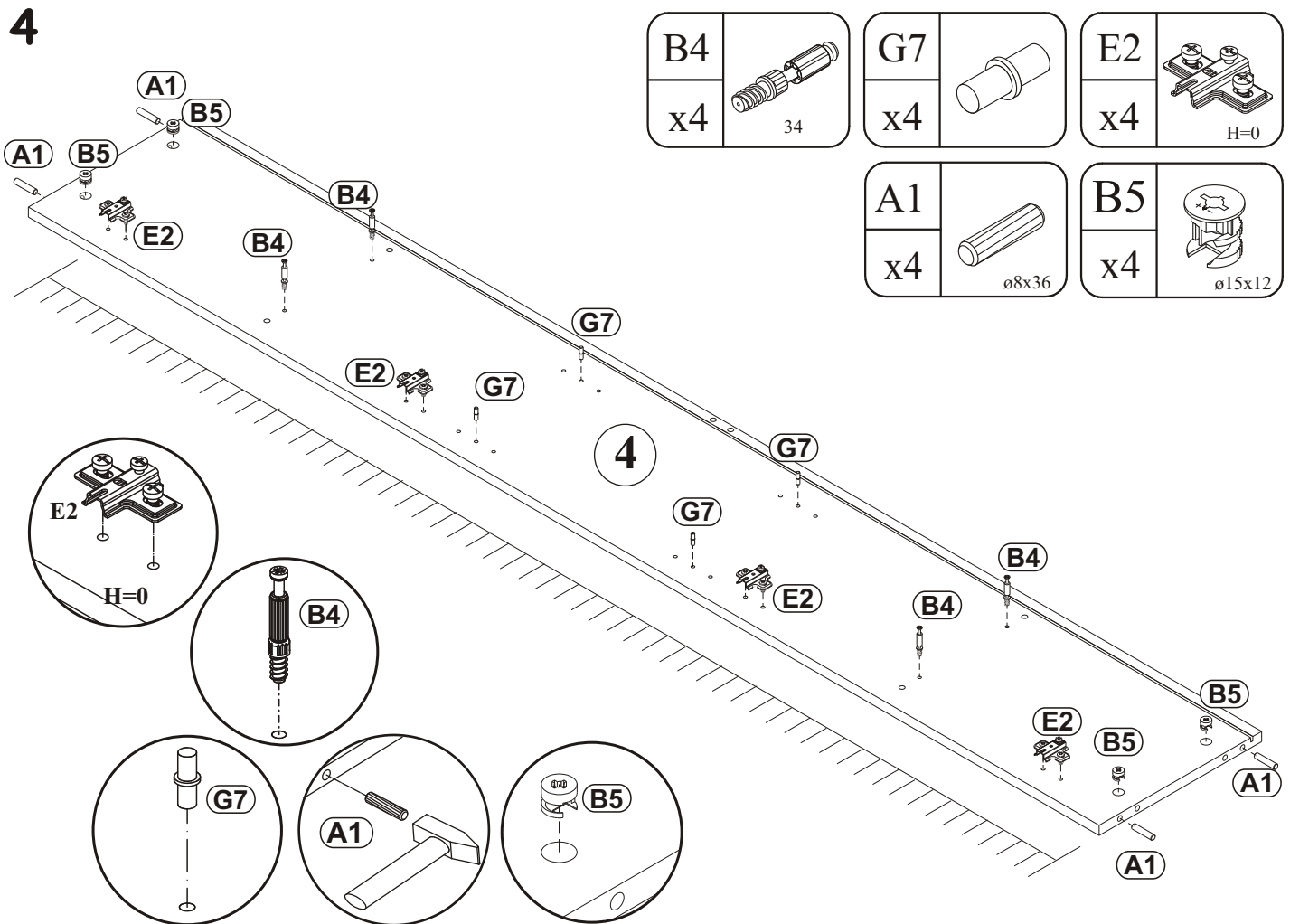
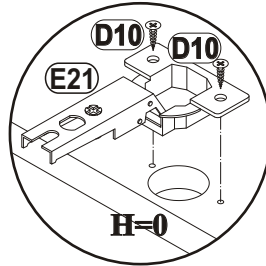
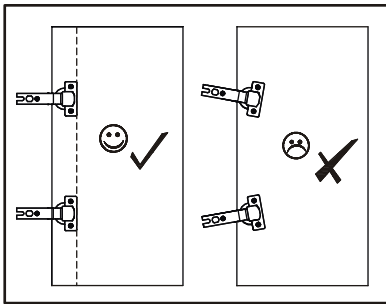
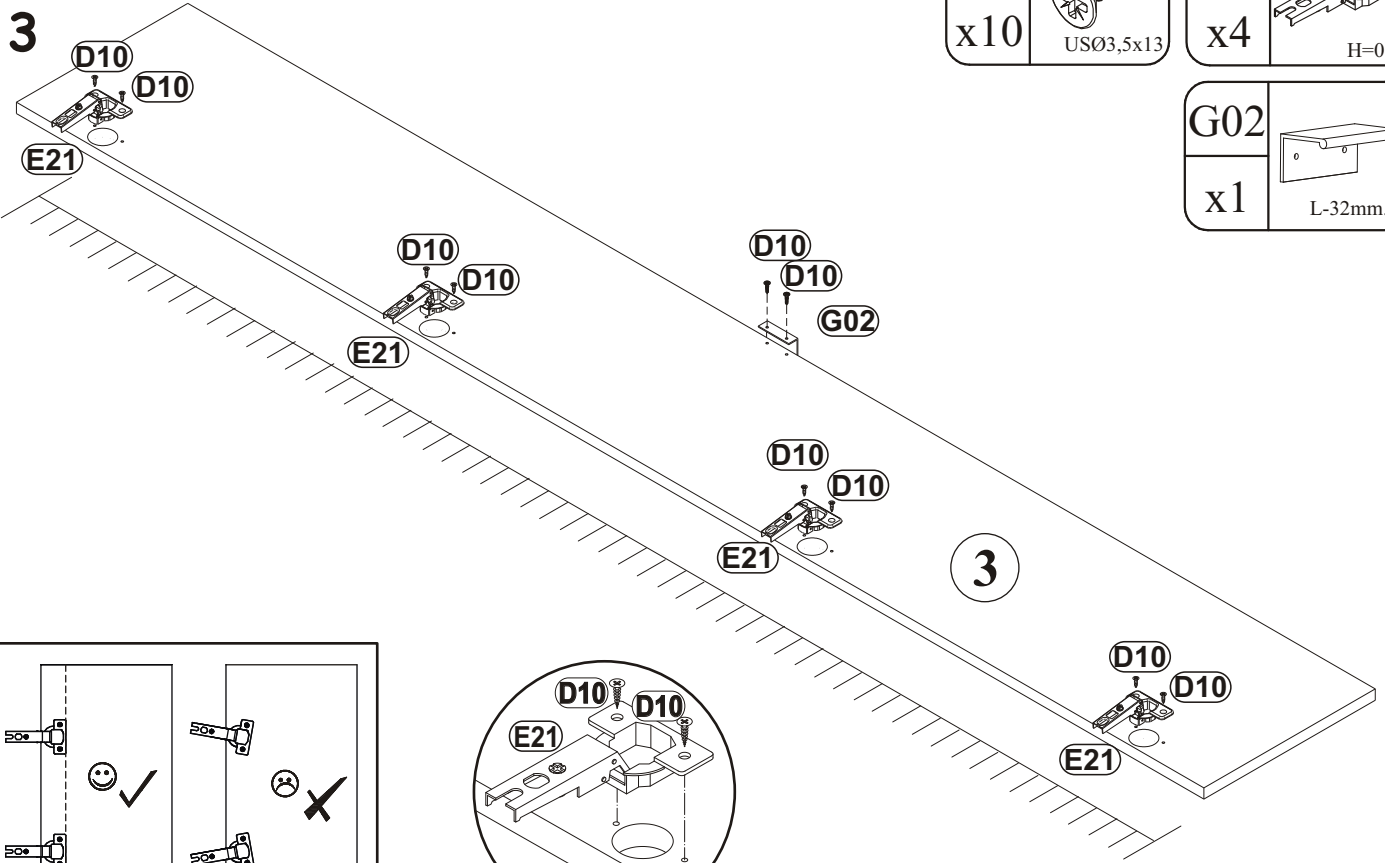

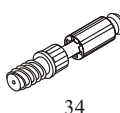
B4	
x4	34

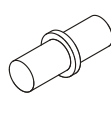
G7	
x4	

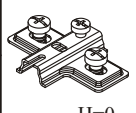
E2	
x4	H=0

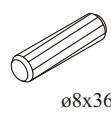
A1	
x4	ø8x36

B5	
x4	ø15x12

5

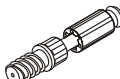
B4	
x4	34

G7	
x4	

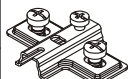
E2	
x4	H=0

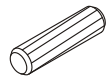
A1	
x4	ø8x36

B5	
x4	ø15x12

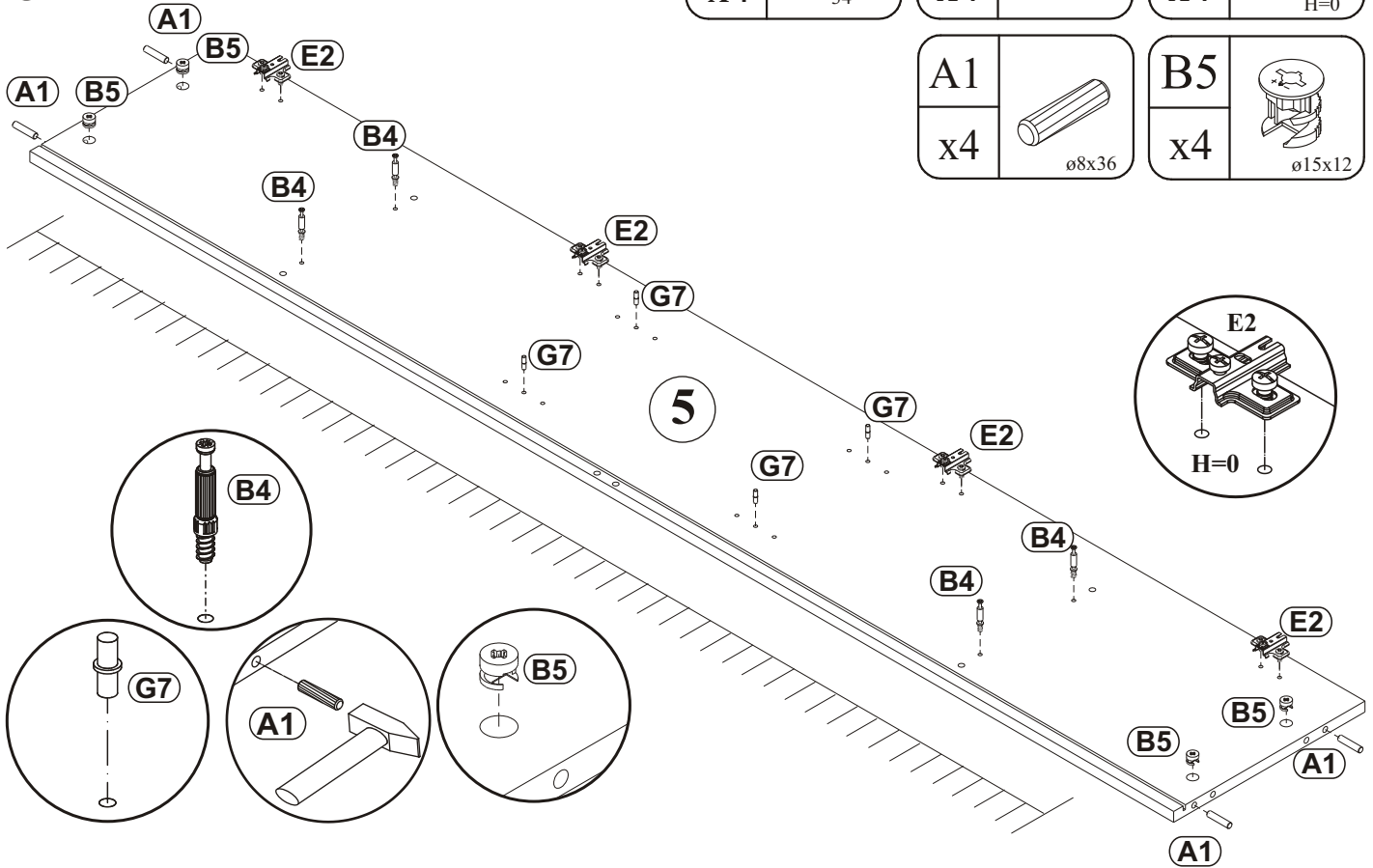

6

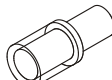
G20	
x2	

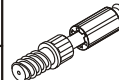
B4	
x4	34

UP17	
x4	UPØ4x25

ST7	
x4	Ø50, h=25

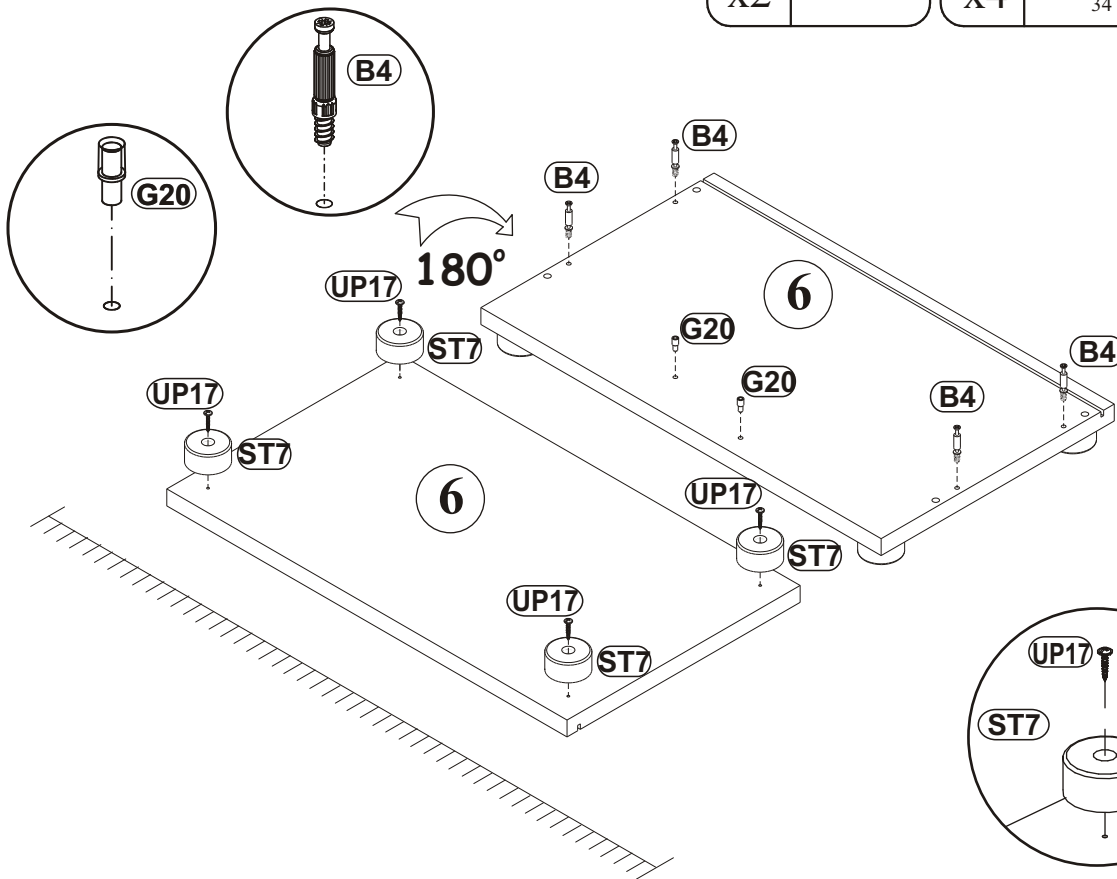

7

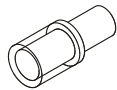
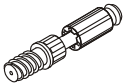
G20		B4	
x2		x4	34

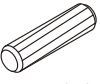
A1	
x4	ø8x36

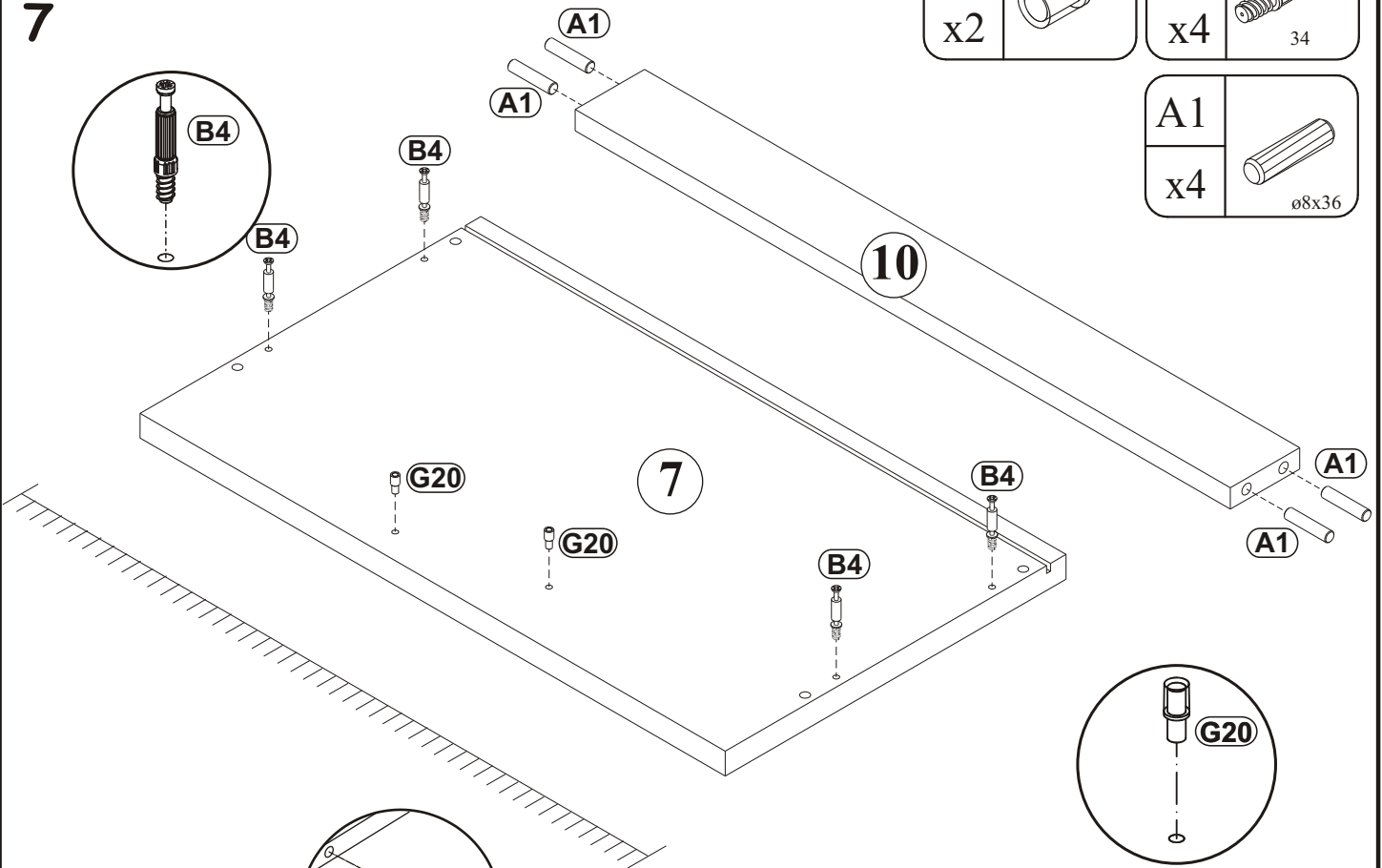

8

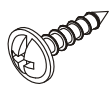
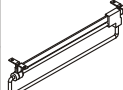
UP9		C6	
x4	UPØ3,5x16	x1	L-250mm.

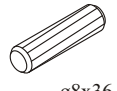
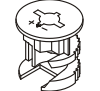
A1		B5	
x8	ø8x36	x8	ø15x12

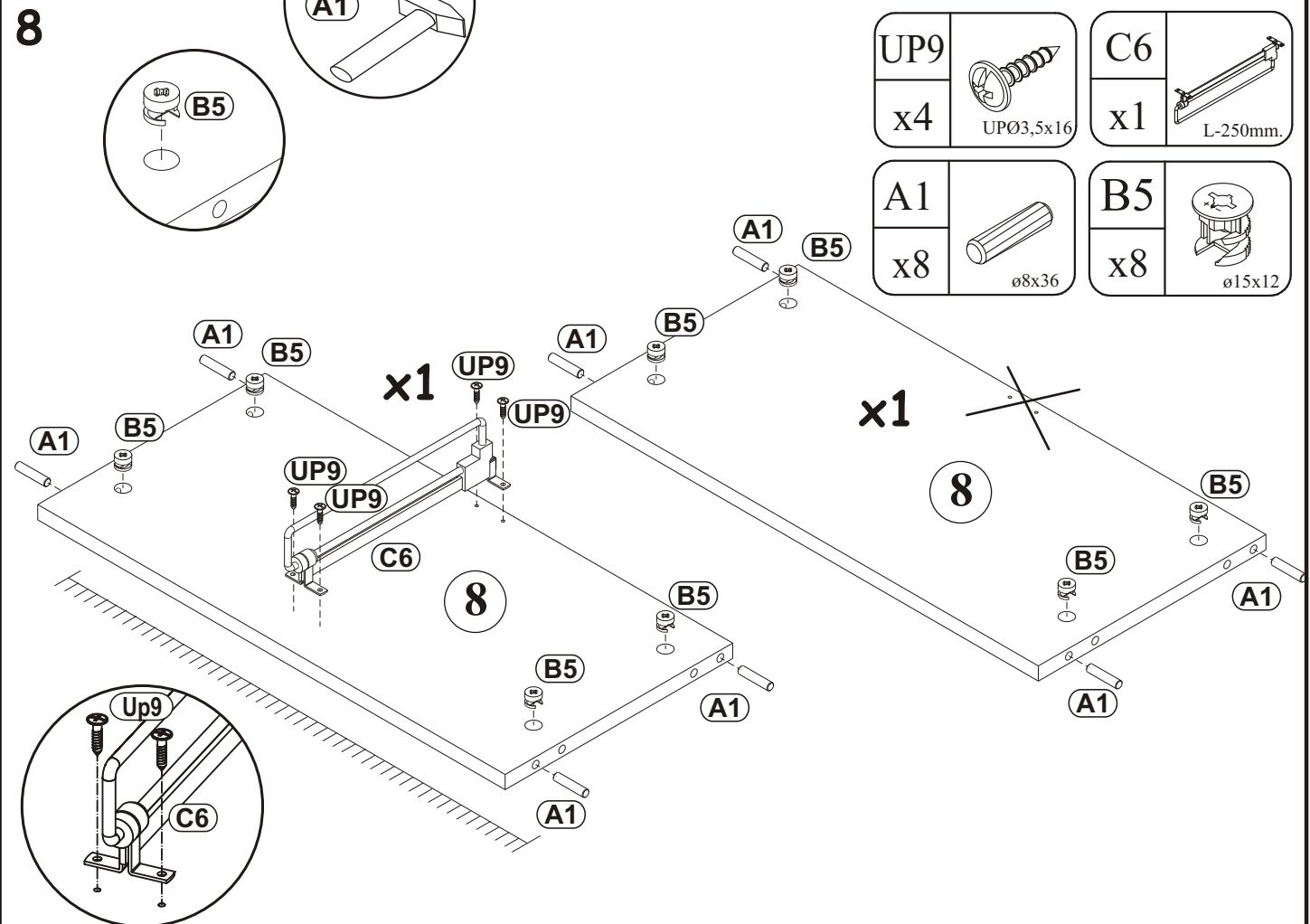

9

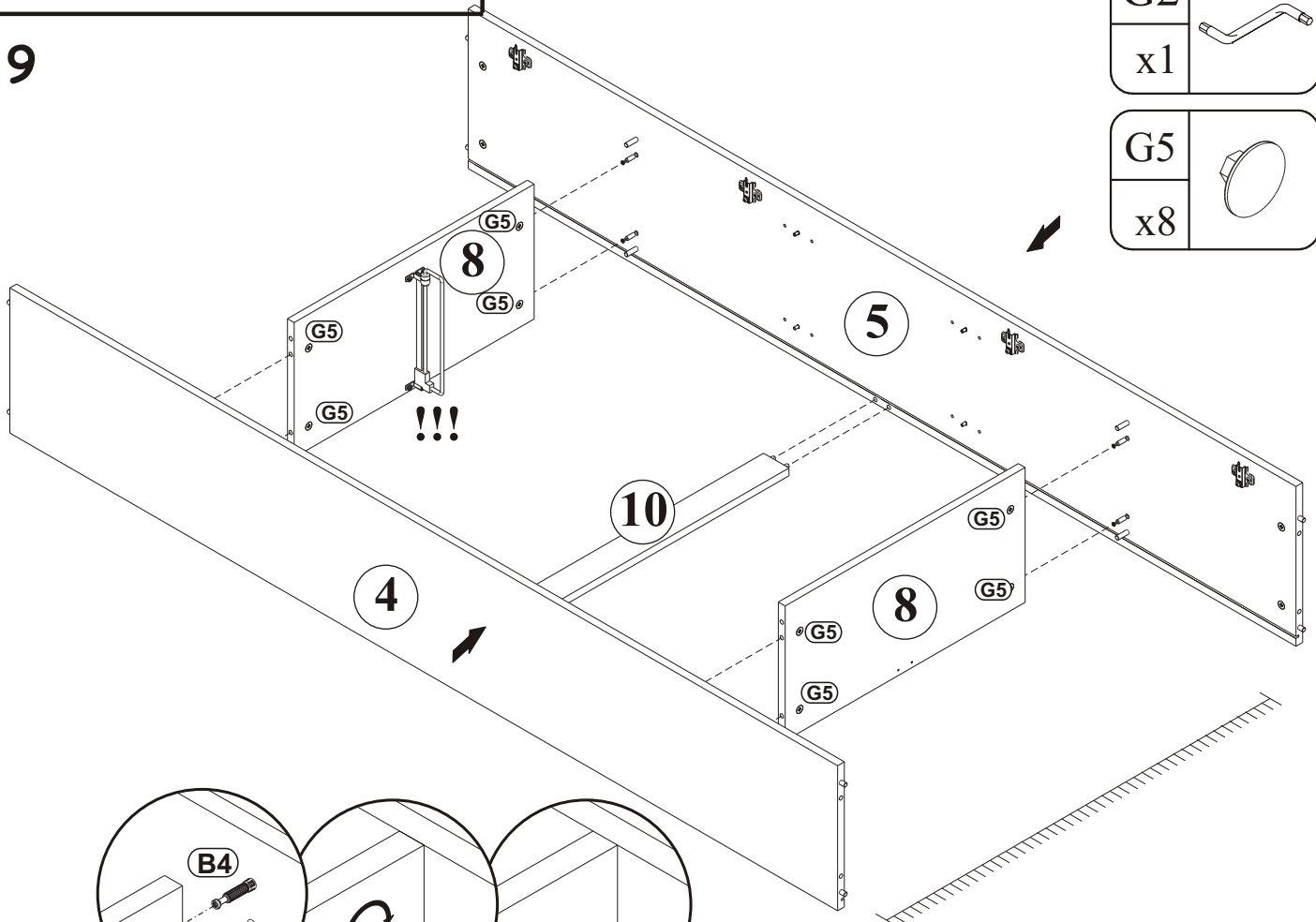

G2	
x1	

G5	
x8	

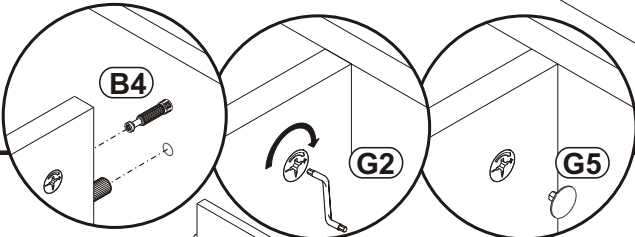

10

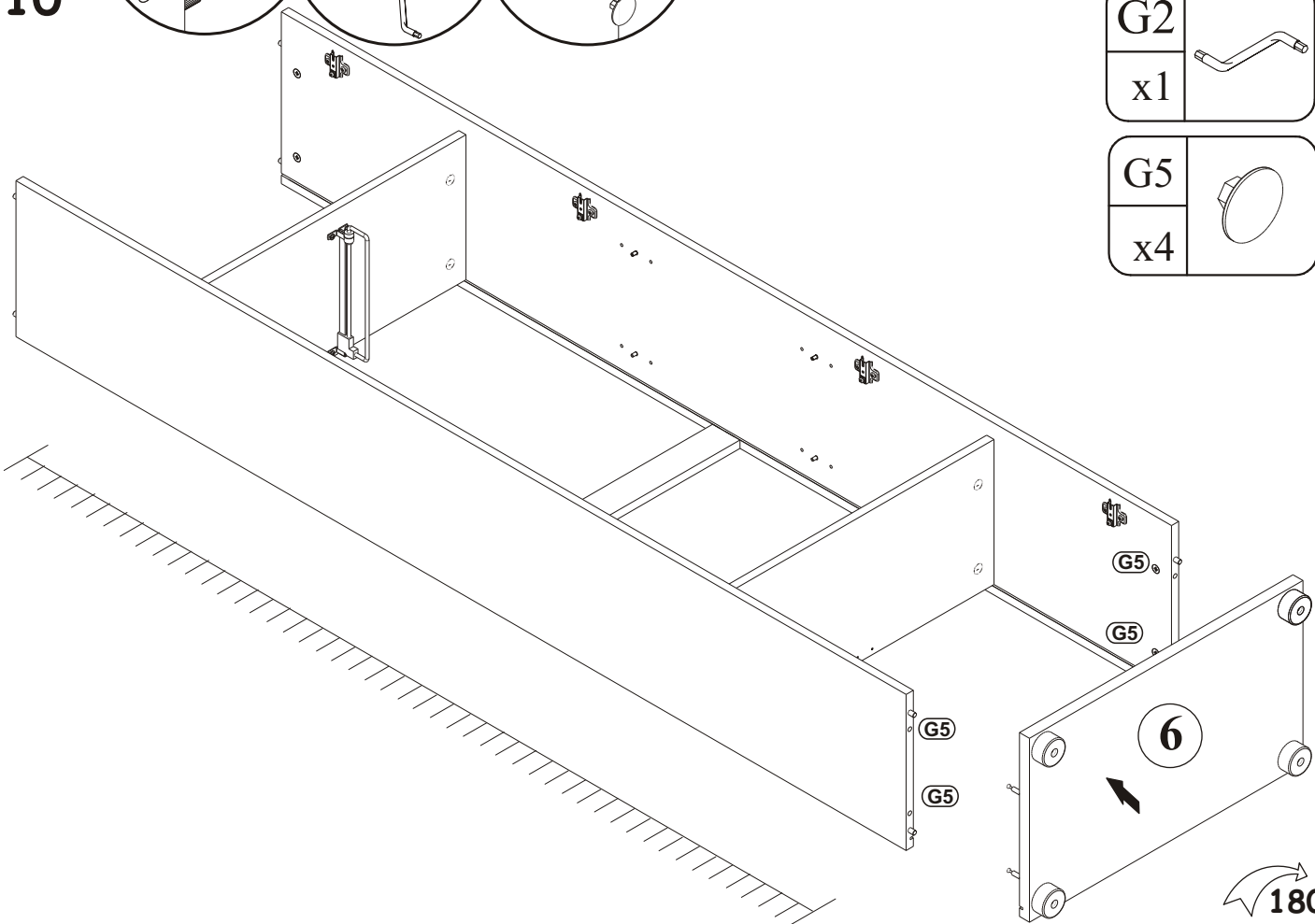

G2	
x1	

G5	
x4	



11

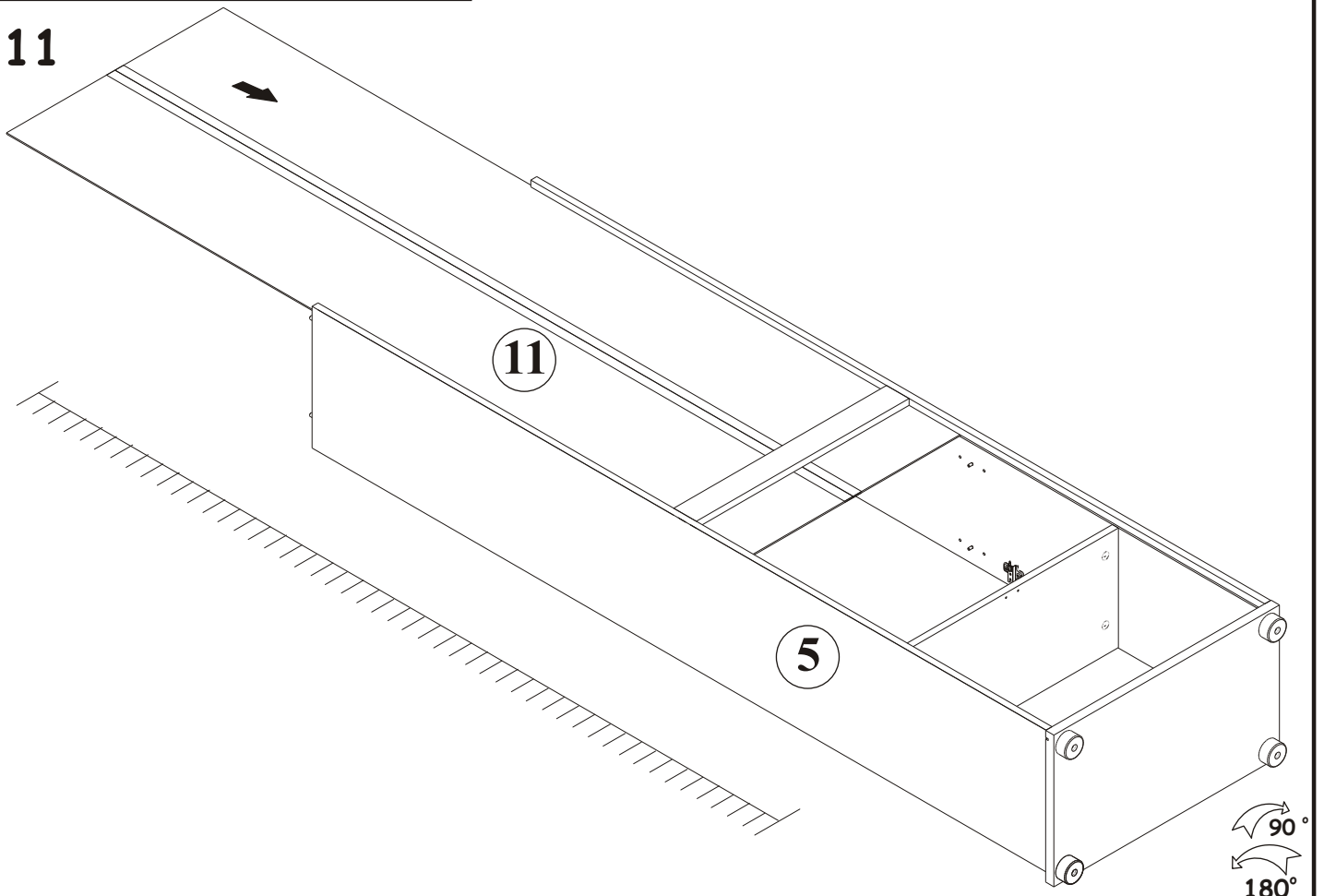

12

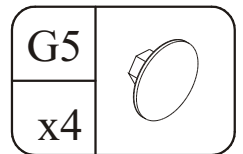
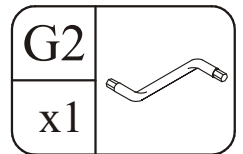
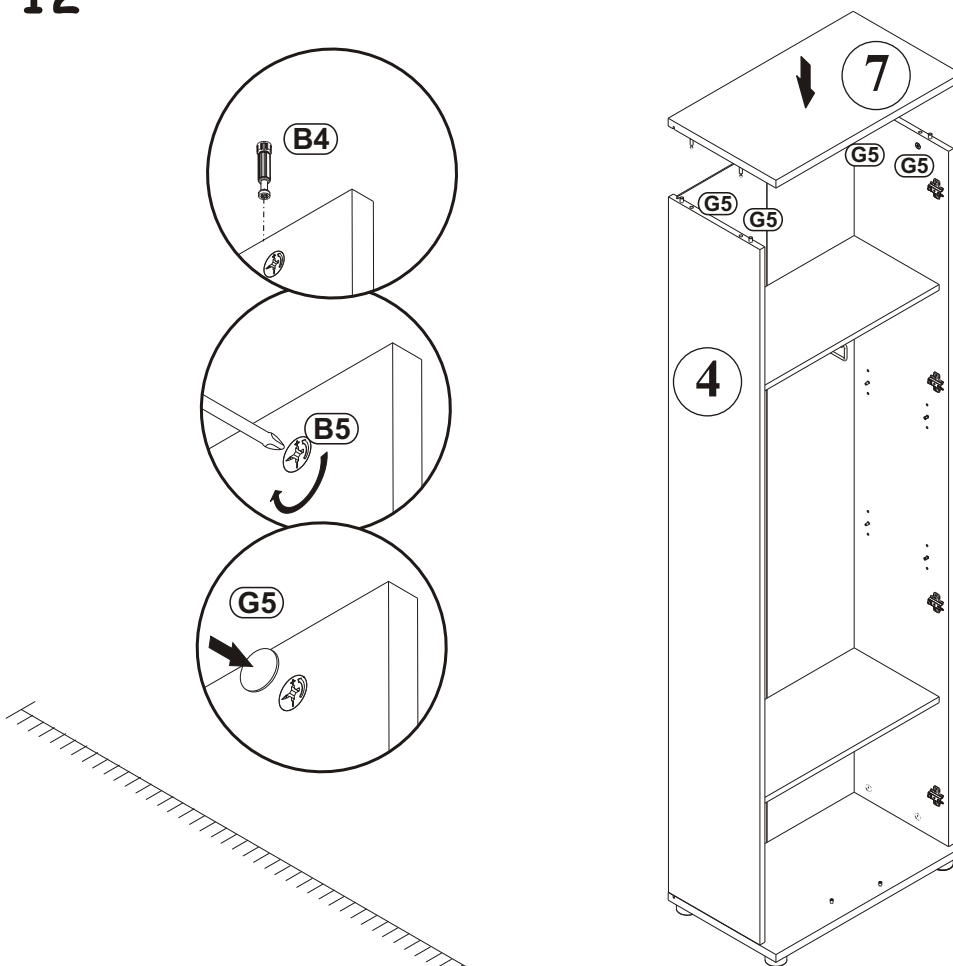

15

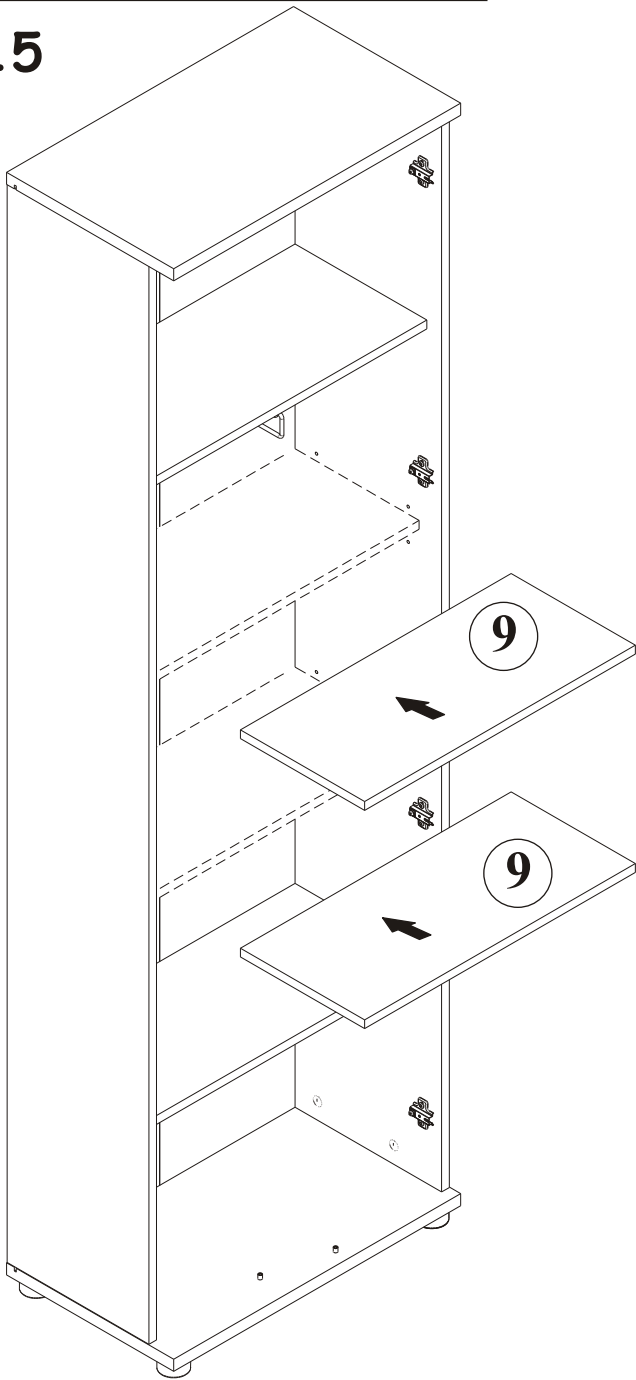

16

