

PEDRO HJZ PD ___ TYP A

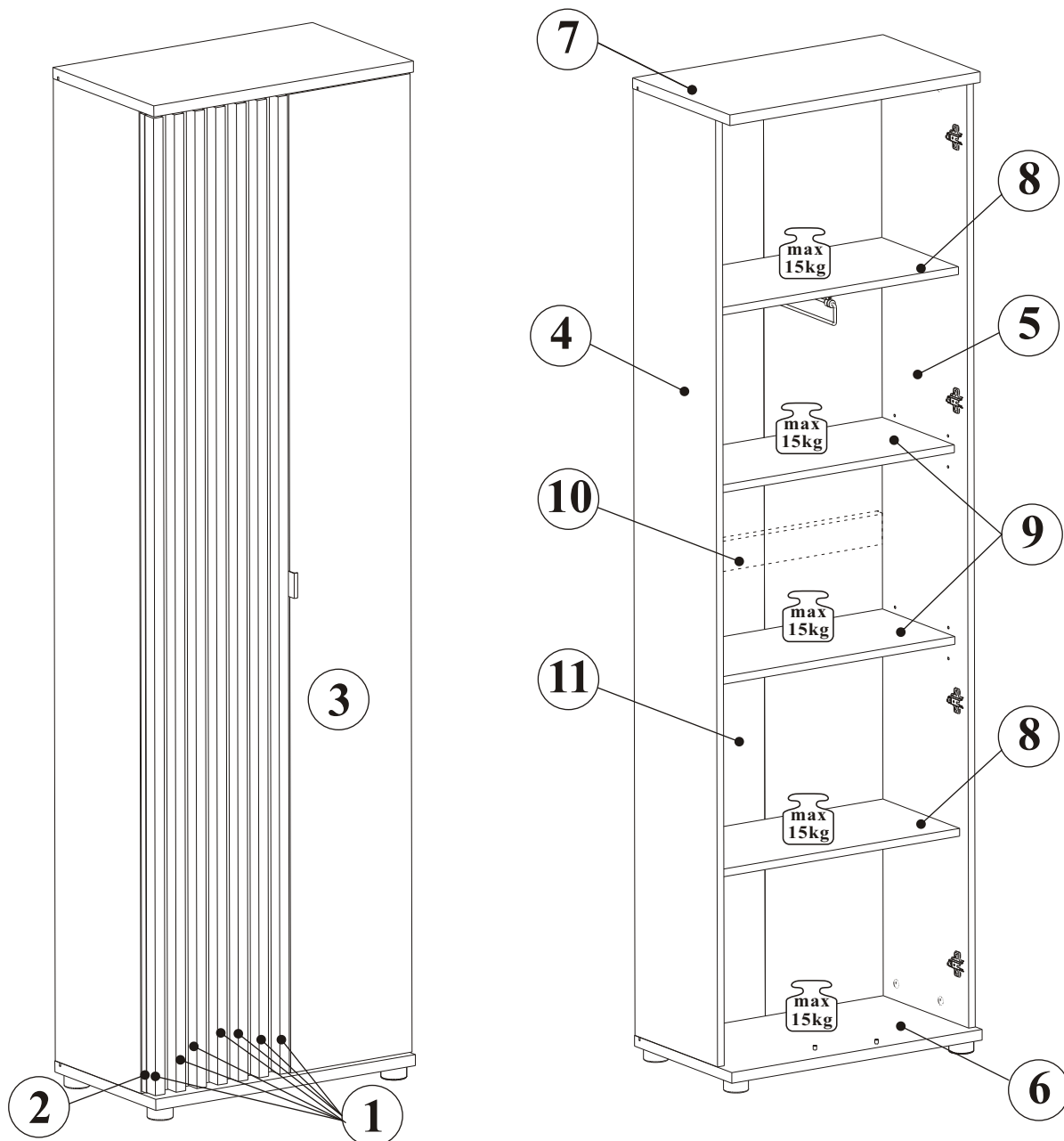

NO	DIM [mm]		COL.-NO	QTY
1	1946	30	22 1/2	7
2	312	1948	16 1/2	1
3	281	1948	16 1/2	1
4	1956	297	16 2/2	1
5	1956	327	16 2/2	1
6	601	350	22 2/2	1
7	601	350	22 2/2	1
8	567	276	16 2/2	2
9	567	260	16 2/2	2
10	567	60	16 2/2	1
11	1967	578	3 1/2	1

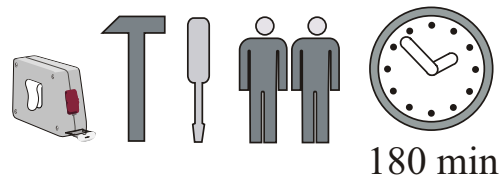



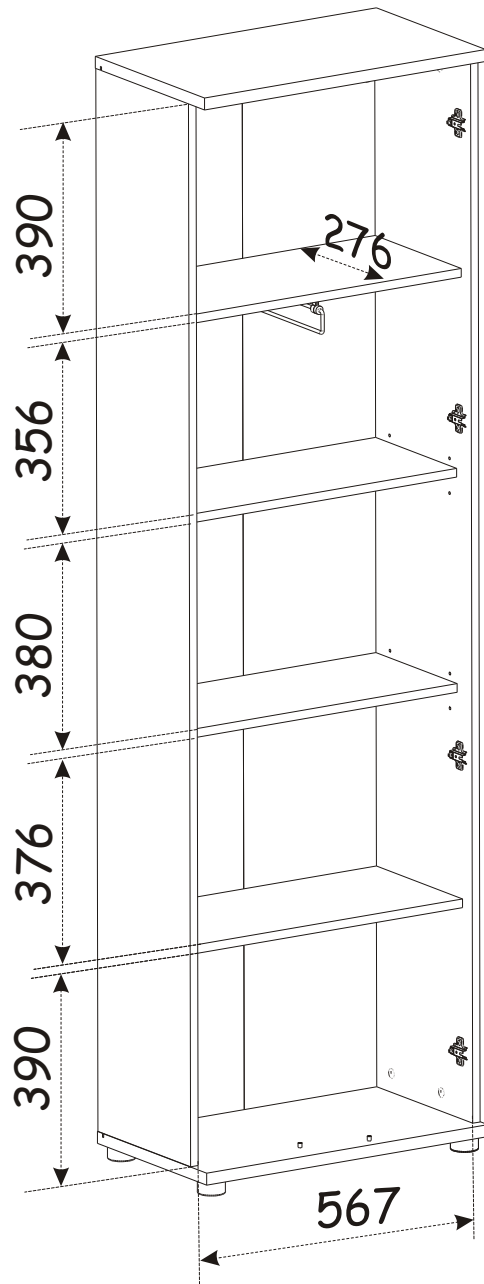
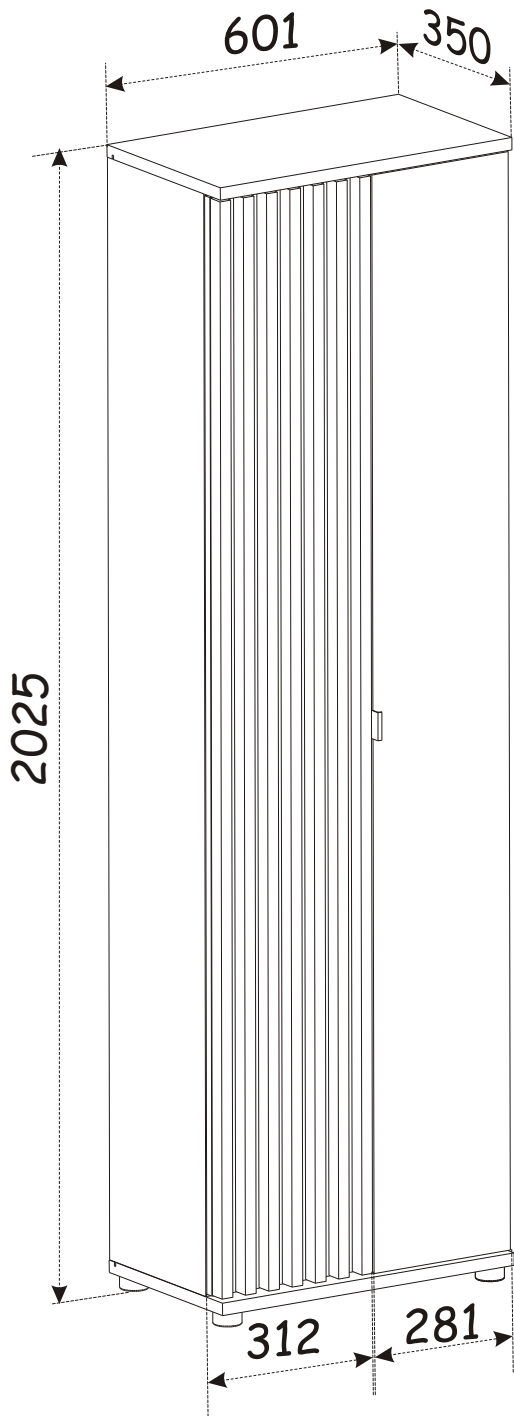

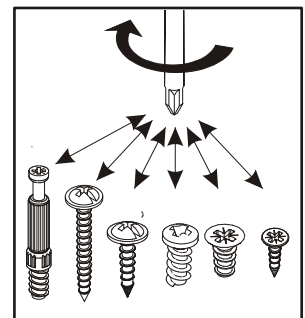
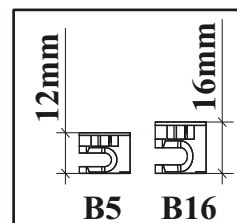
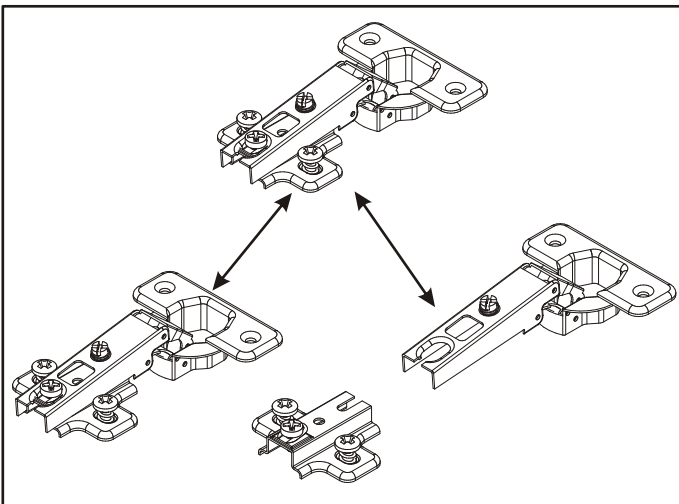
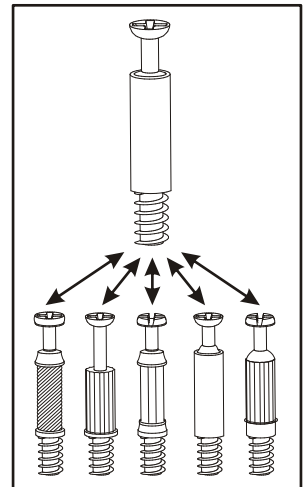
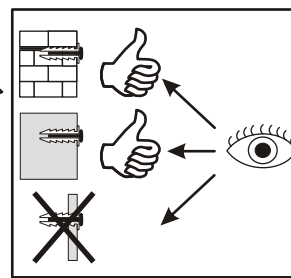
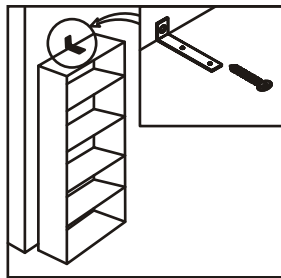
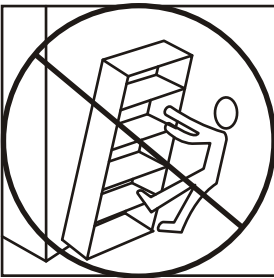
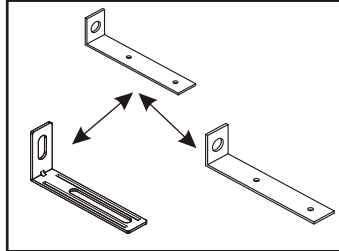
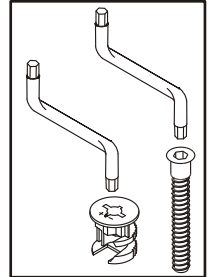
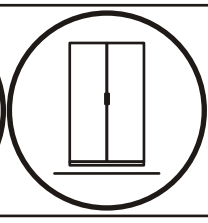
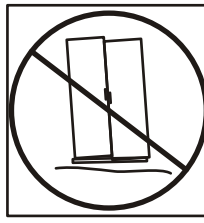
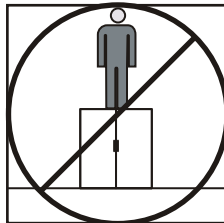
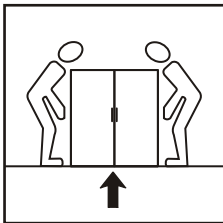
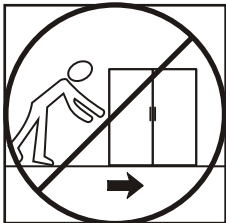
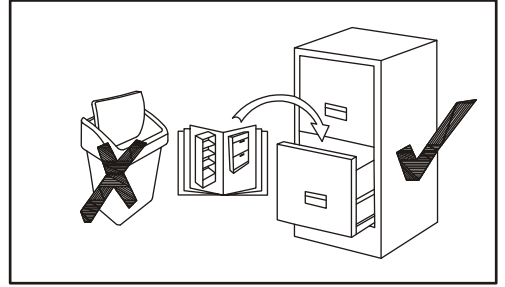
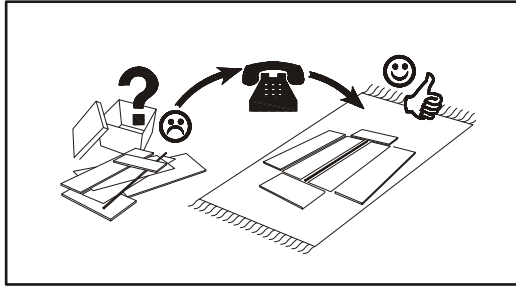
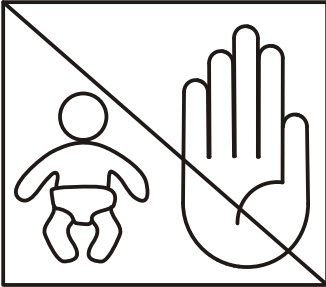
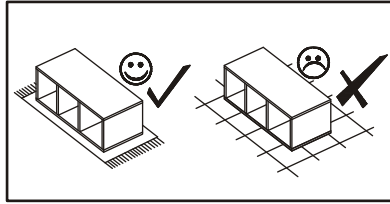
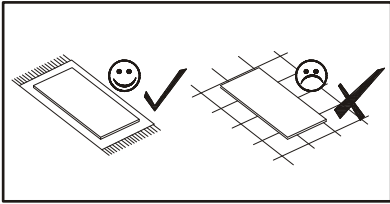



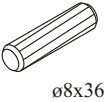

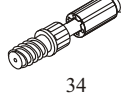
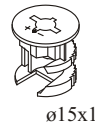
PEDRO HJZ PD _ TYP A

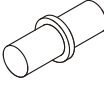
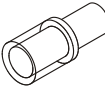
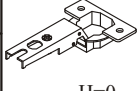
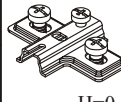
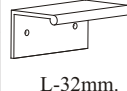

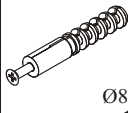
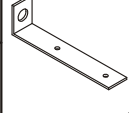
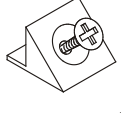
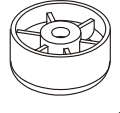
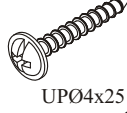

PEDRO HJZ PD _ TYP A

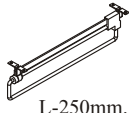
A1 x20  ø8x36	B22 x35  Ø7x40	G4 x30 	B4 x16  34	B5 x16  ø15x12	G5 x16 
G7 x8 	G20 x4 	E21 x8  Ø35 H=0	E2 x8  H=0	G02 x1  L-32mm.	G12 x5  Ø14
KR1 x2  Ø8	L1 x2 	S1 x16 	ST7 x4  Ø50, h=25	UP17 x4  UPØ4x25	D10 x22  USØ3,5x13
UP9 x16  UPØ3,5x16	G2 x1 	C6 x1  L-250mm.			

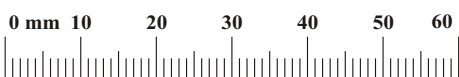

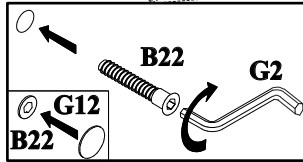
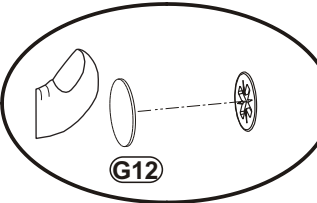
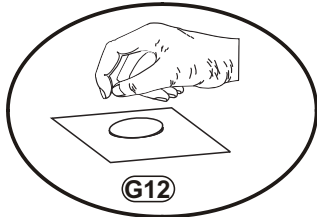
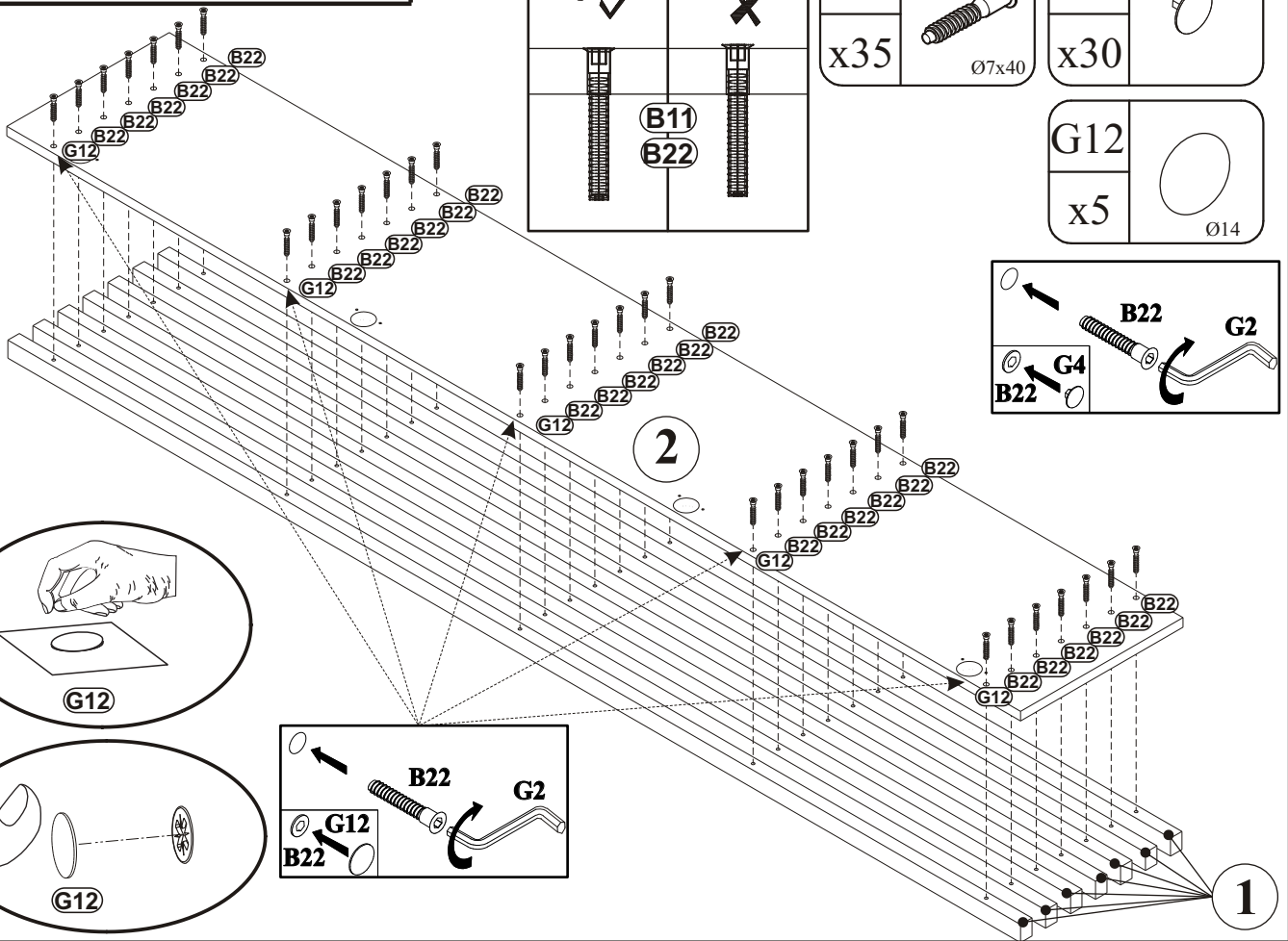

PEDRO HJZ PD _ TYP A

1

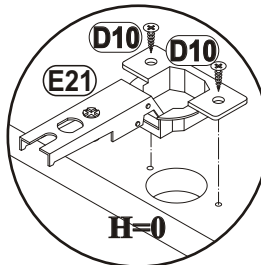
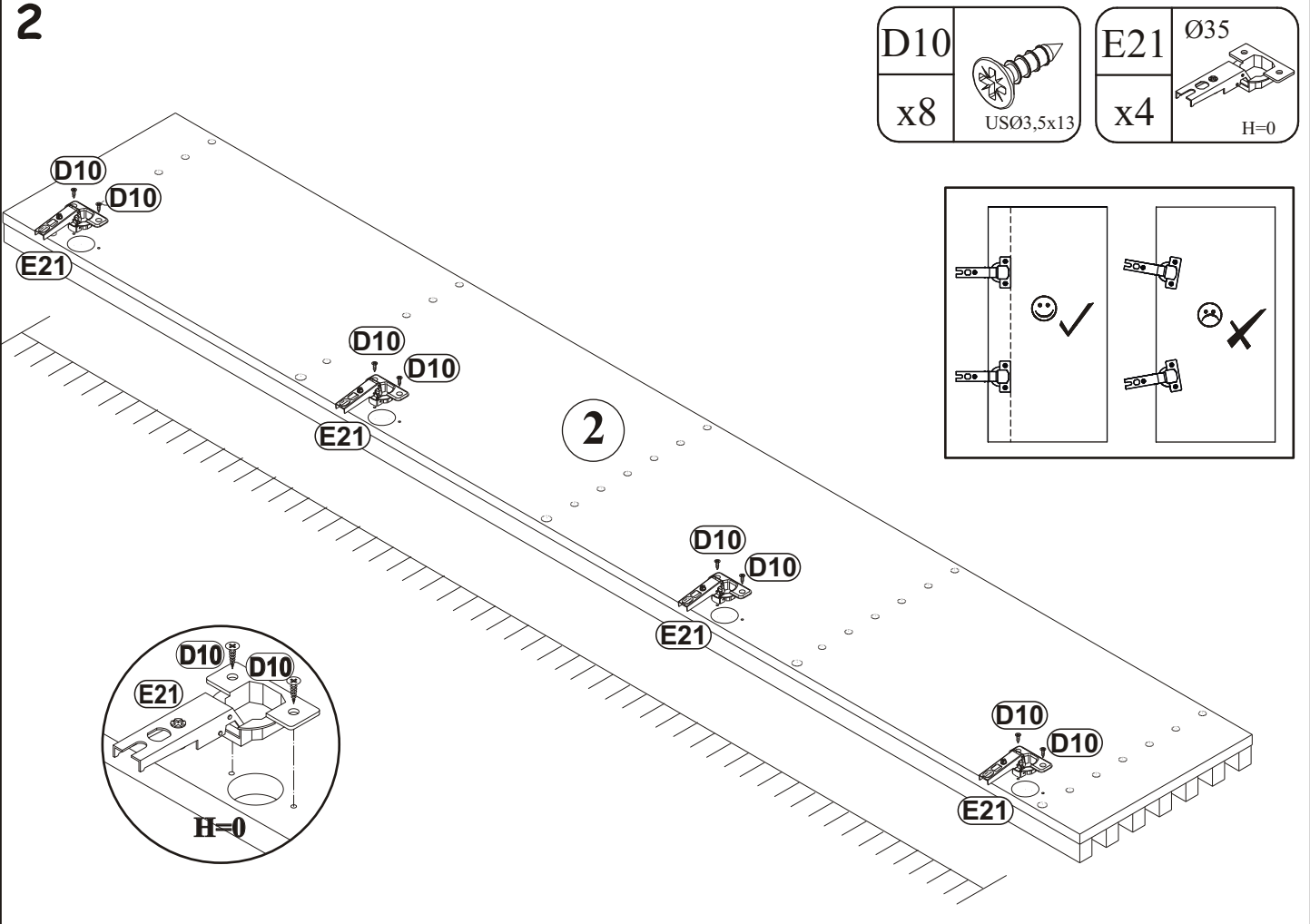

2

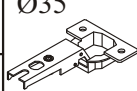

D10	
x10	USØ3,5x13

E21	
x4	Ø35 H=0

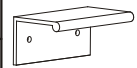
G02	
x1	L-32mm.

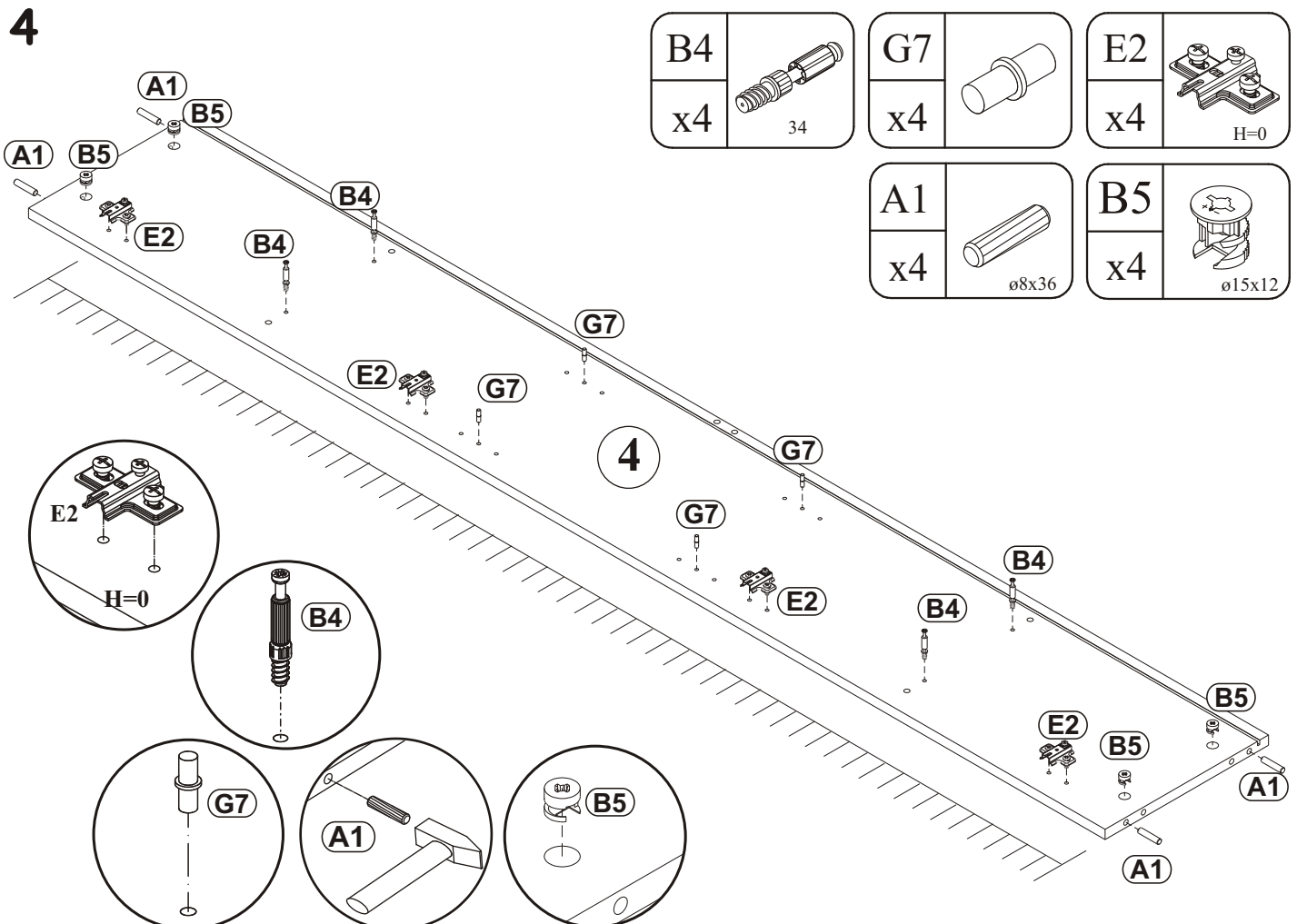
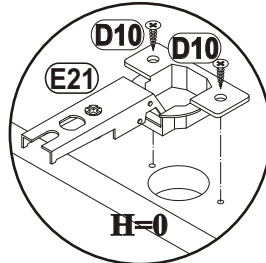
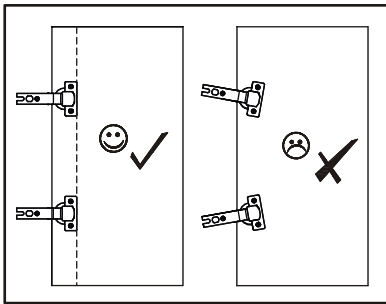
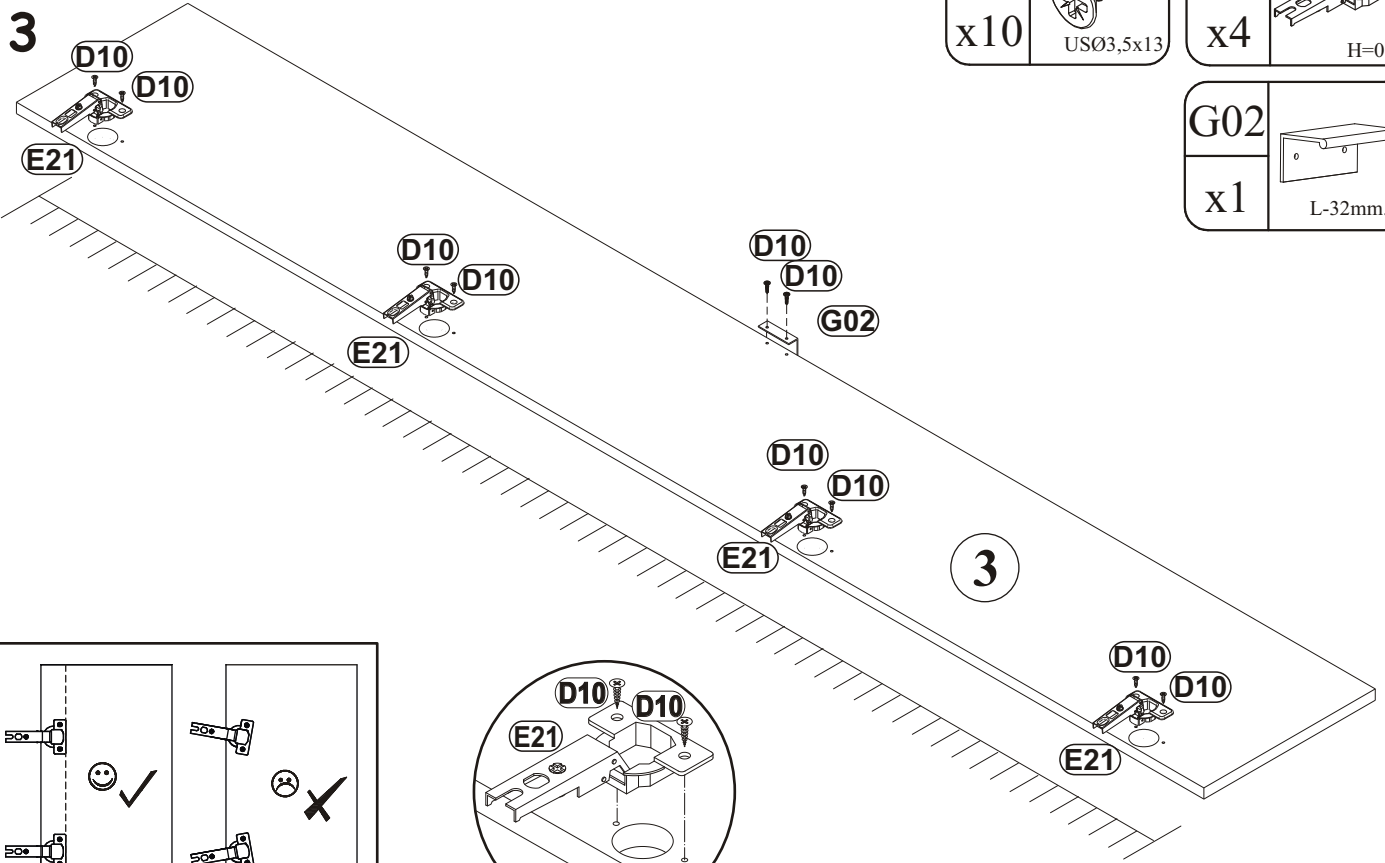

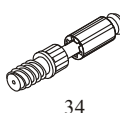
B4	
x4	34

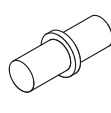
G7	
x4	

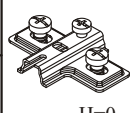
E2	
x4	H=0

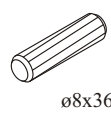
A1	
x4	ø8x36

B5	
x4	ø15x12

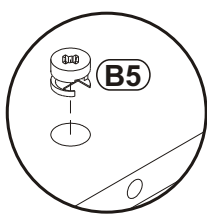
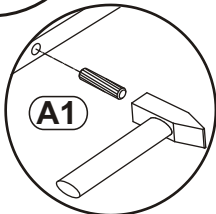
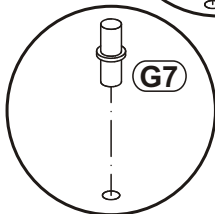
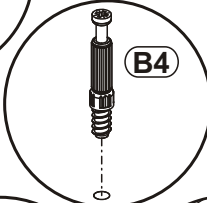
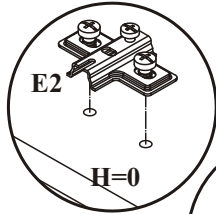

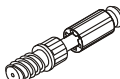

5

B4	
x4	34

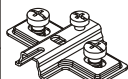
G7	
x4	

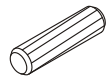
E2	
x4	H=0

A1	
x4	ø8x36

B5	
x4	ø15x12

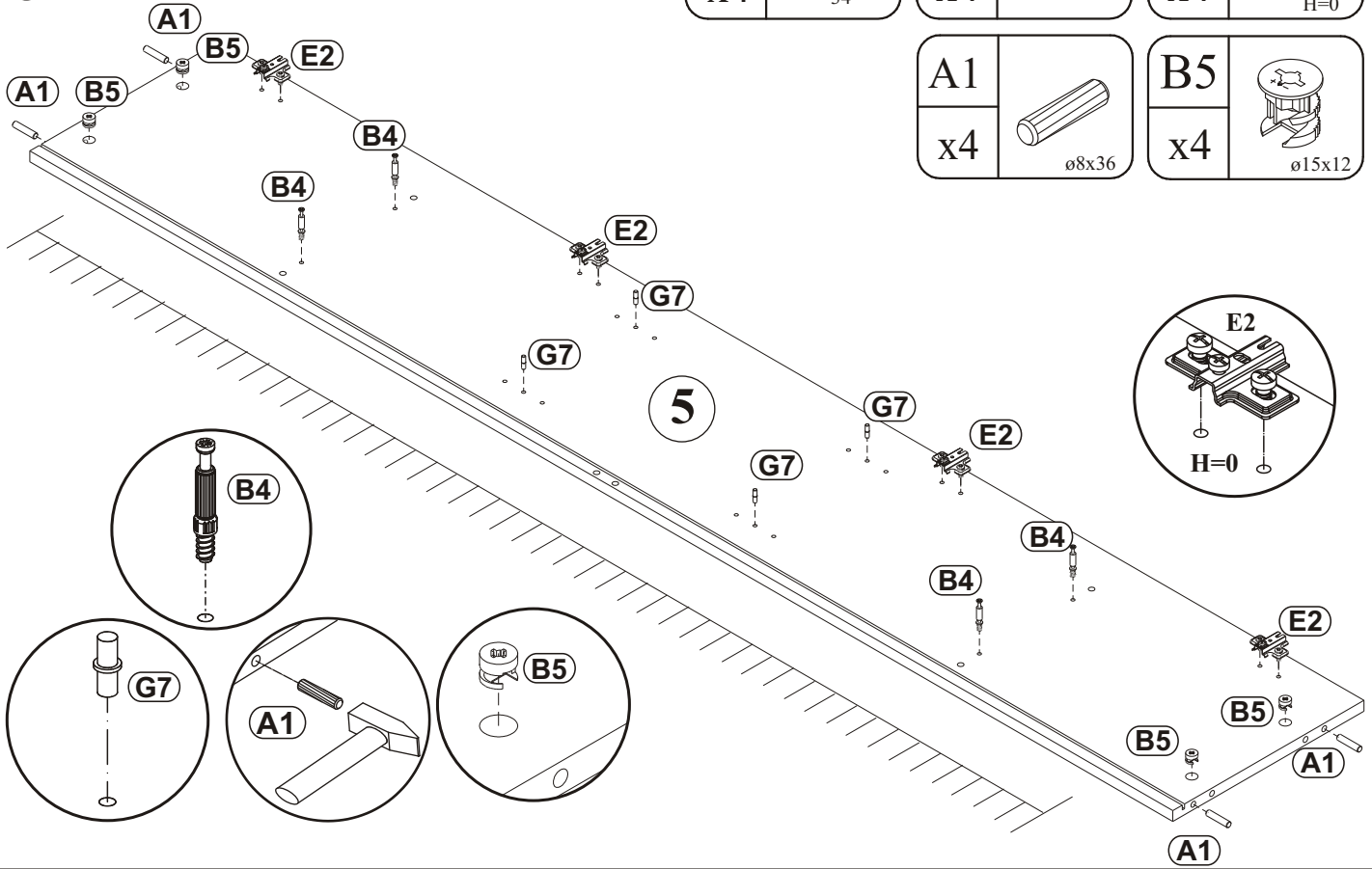

6

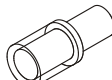
G20	
x2	

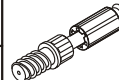
B4	
x4	34

UP17	
x4	UPØ4x25

ST7	Ø50, h=25
x4	

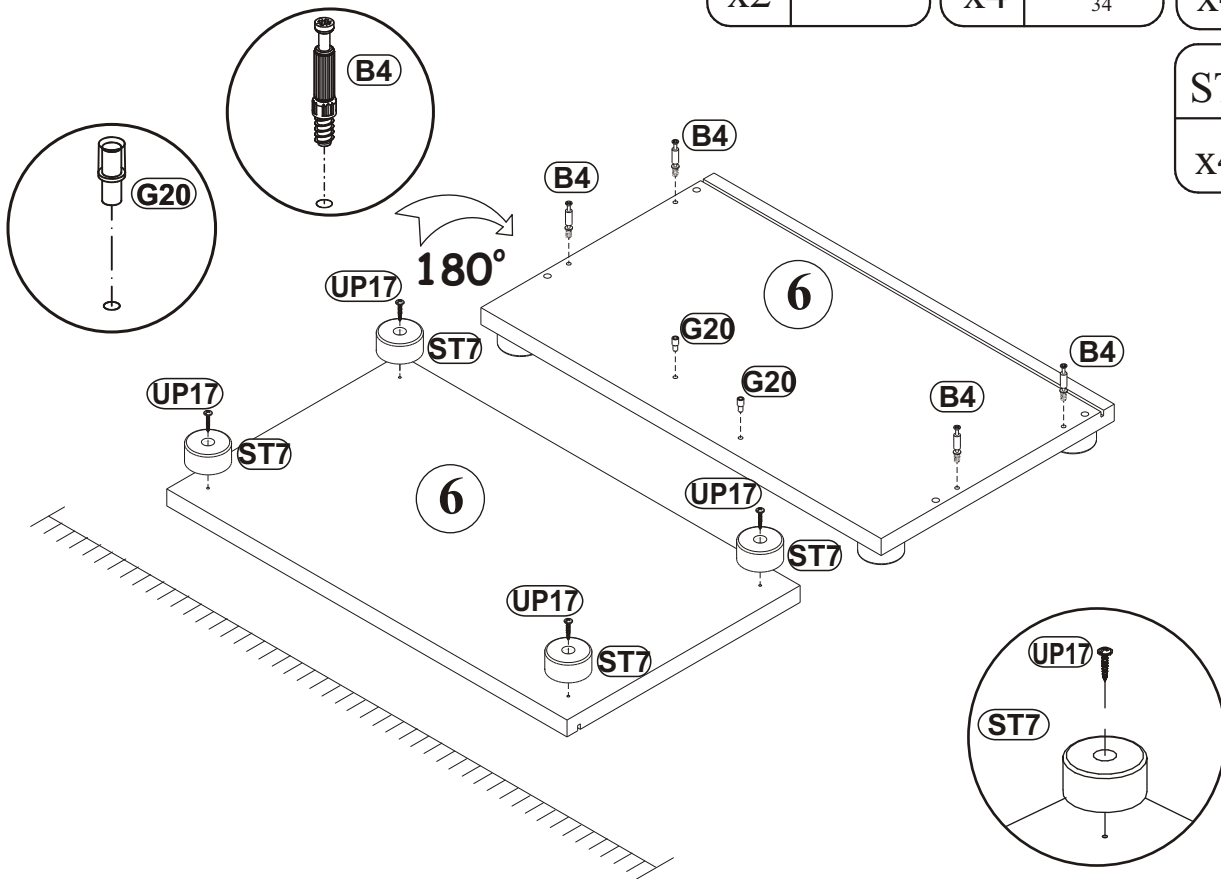

7

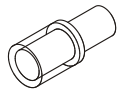
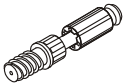

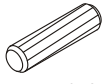
G20		B4	
x2		x4	34

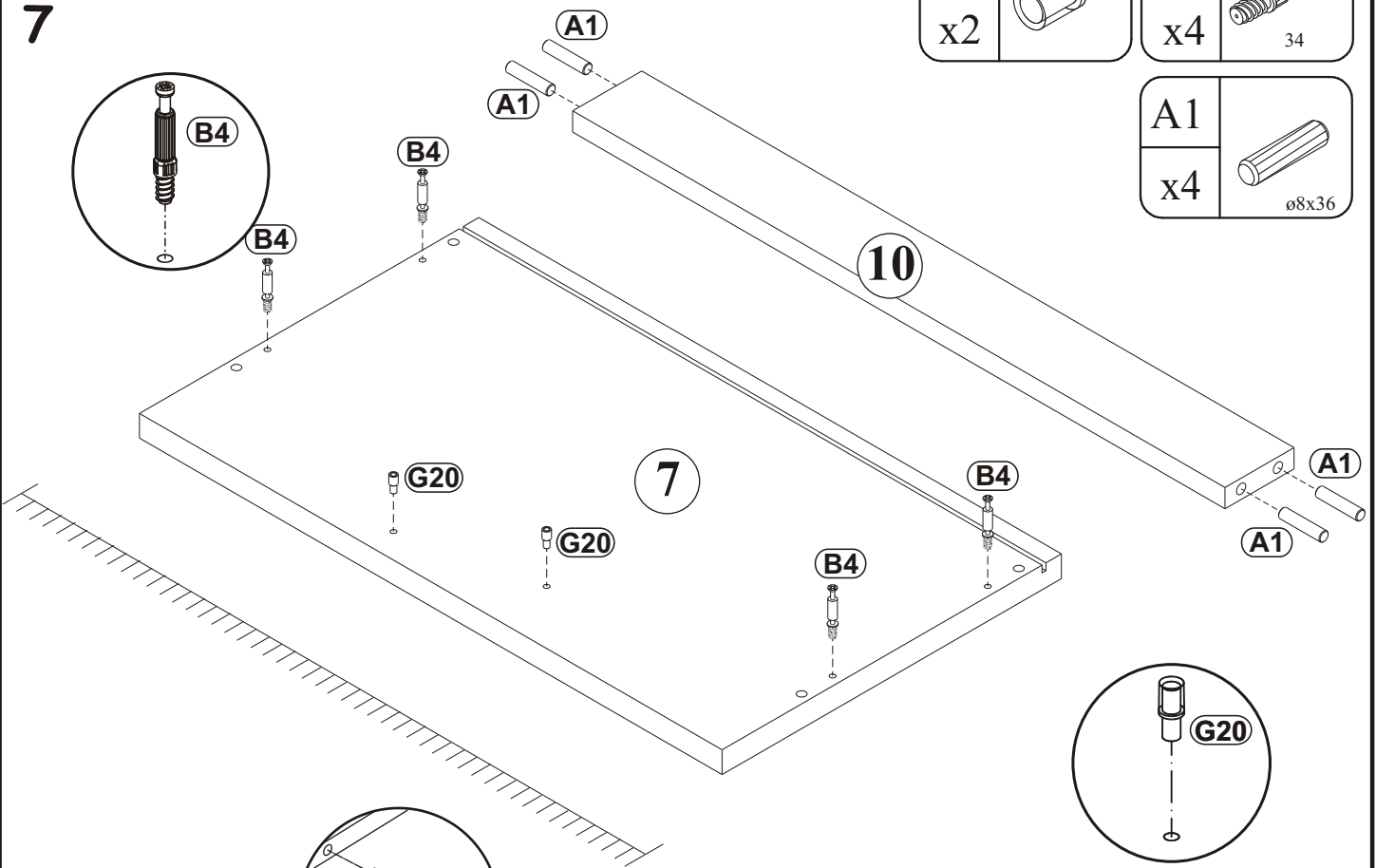
A1	
x4	ø8x36

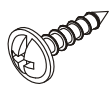
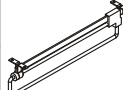

8

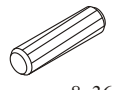
UP9		C6	
x4	UPØ3,5x16	x1	L-250mm.

A1		B5	
x8	ø8x36	x8	ø15x12

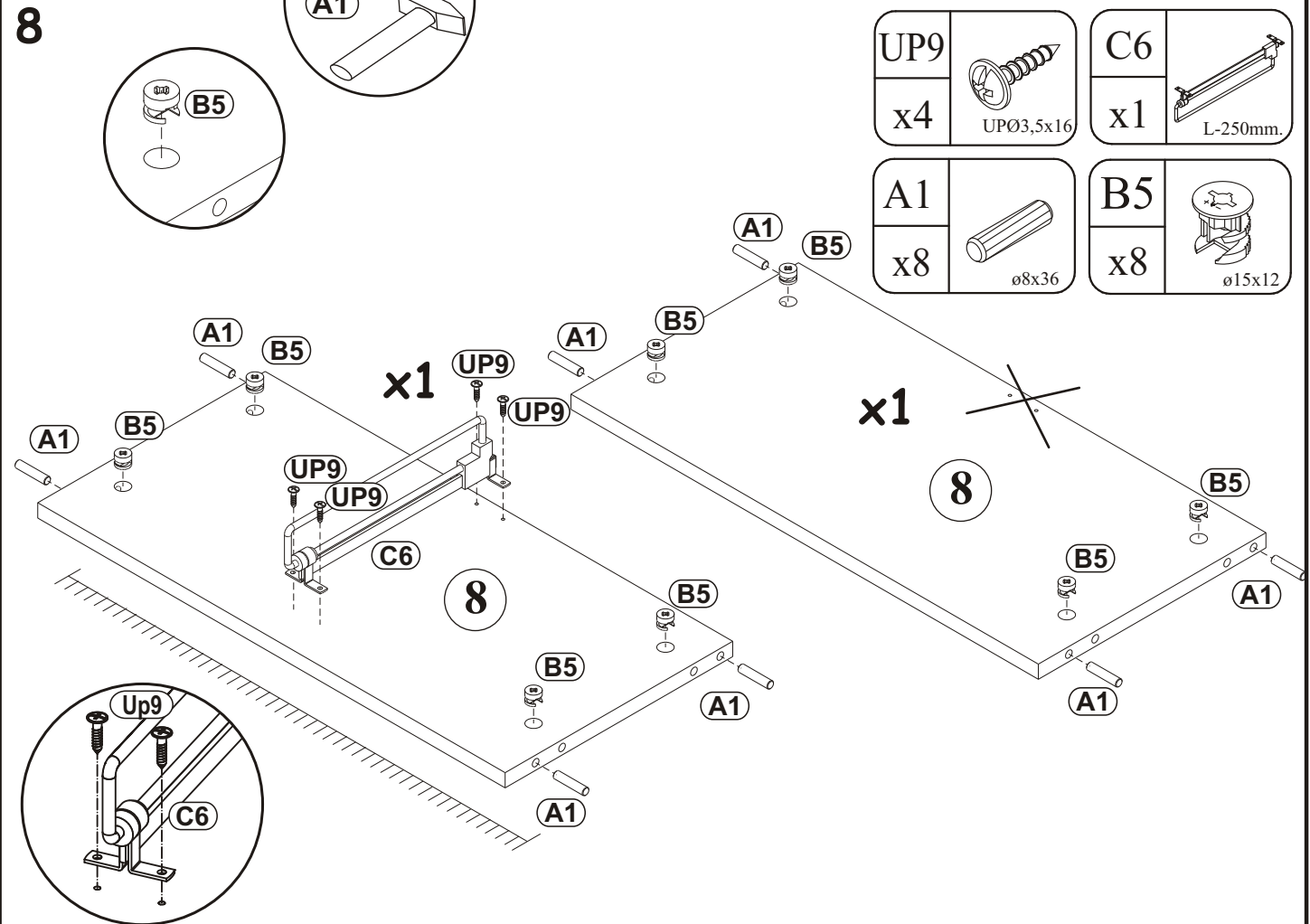

9

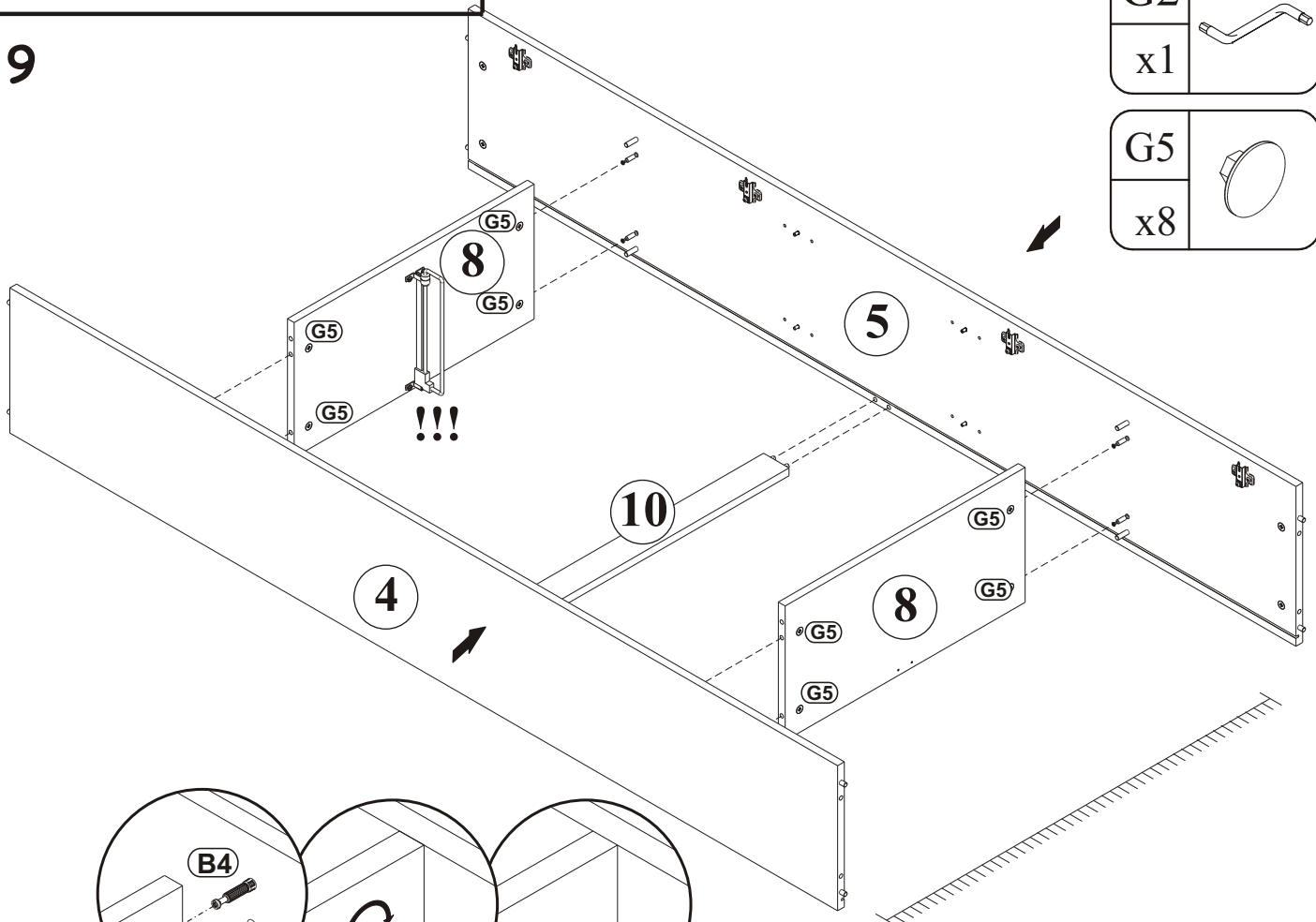

G2	
x1	

G5	
x8	

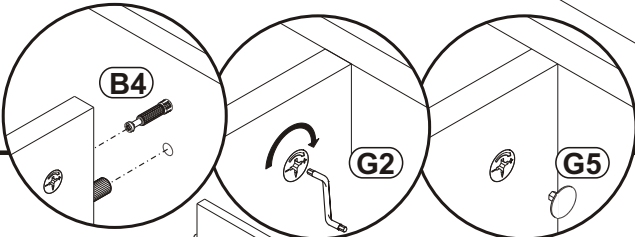

10

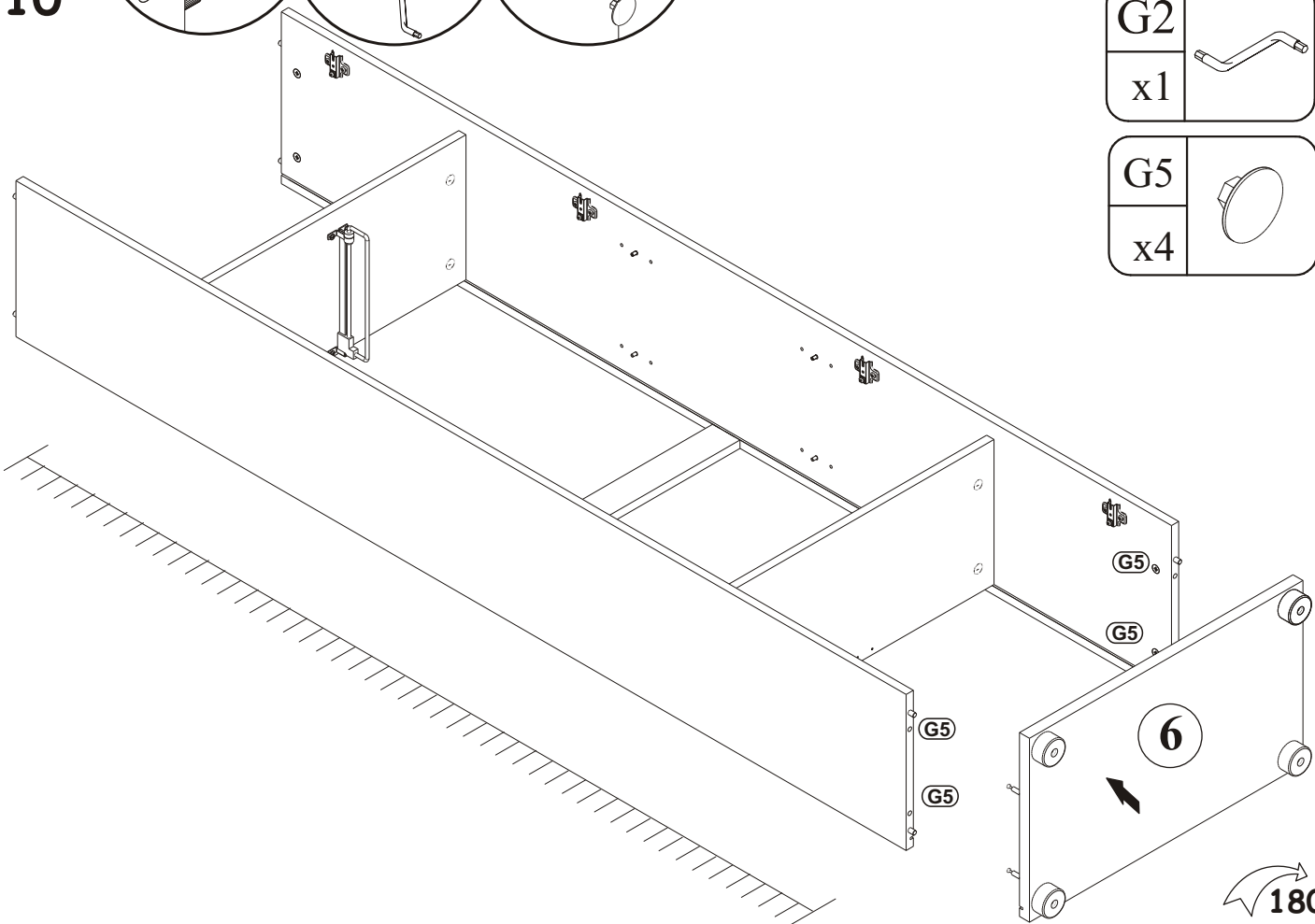

G2	
x1	

G5	
x4	

11

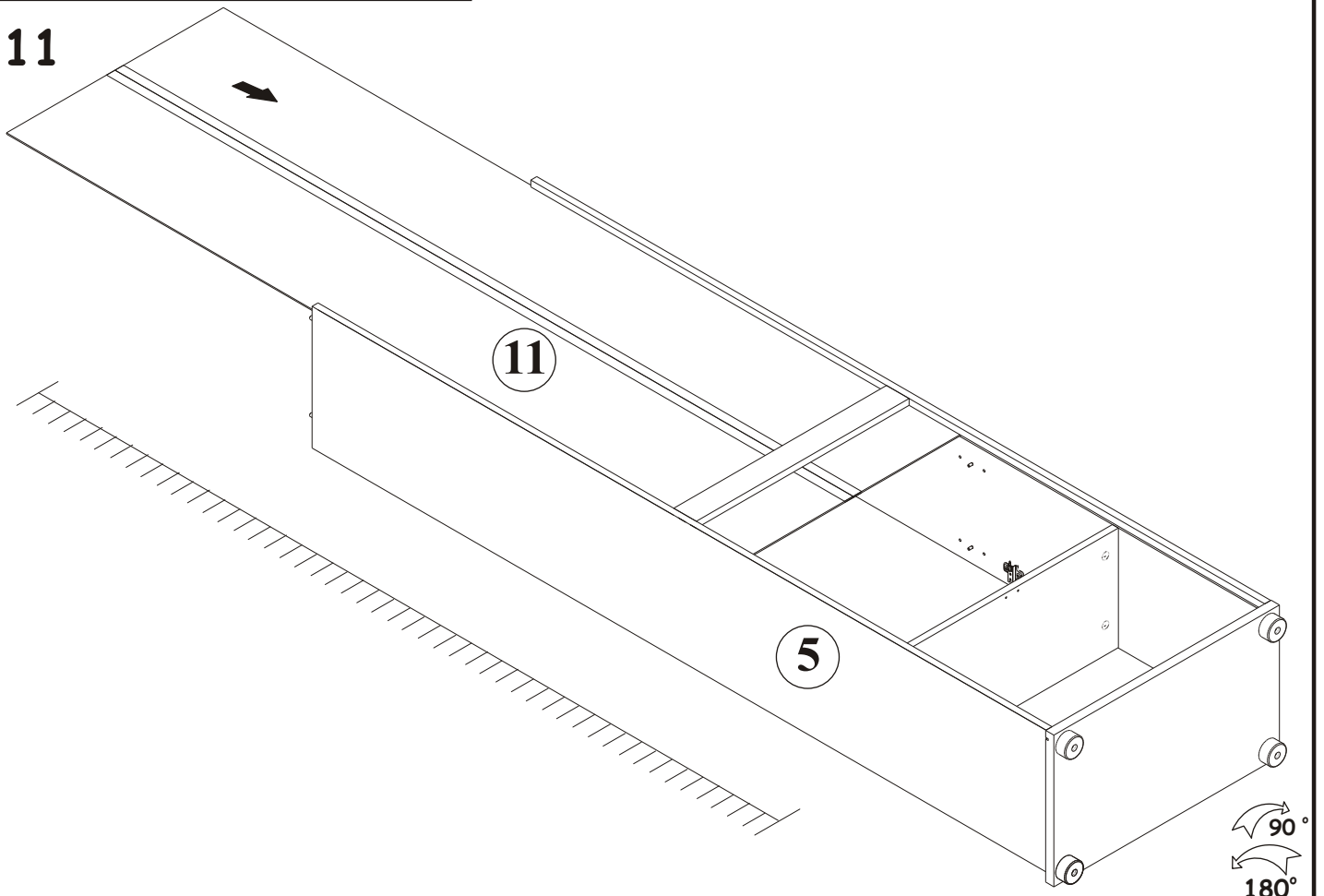

12

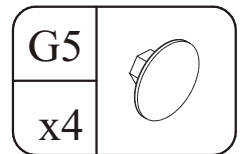
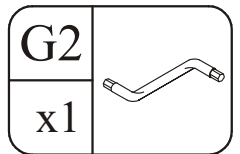
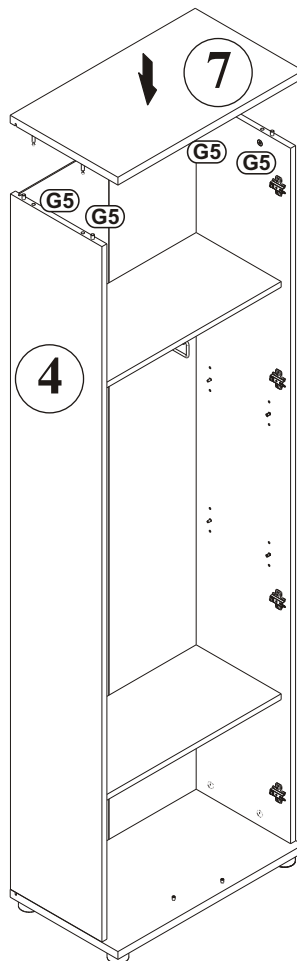
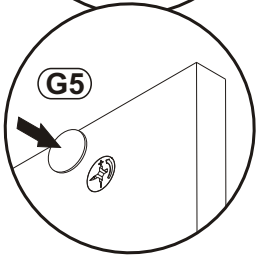
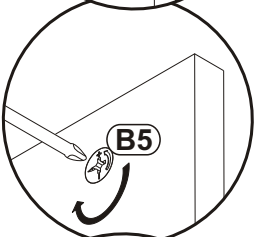
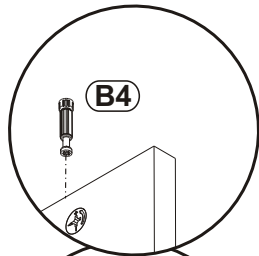

15

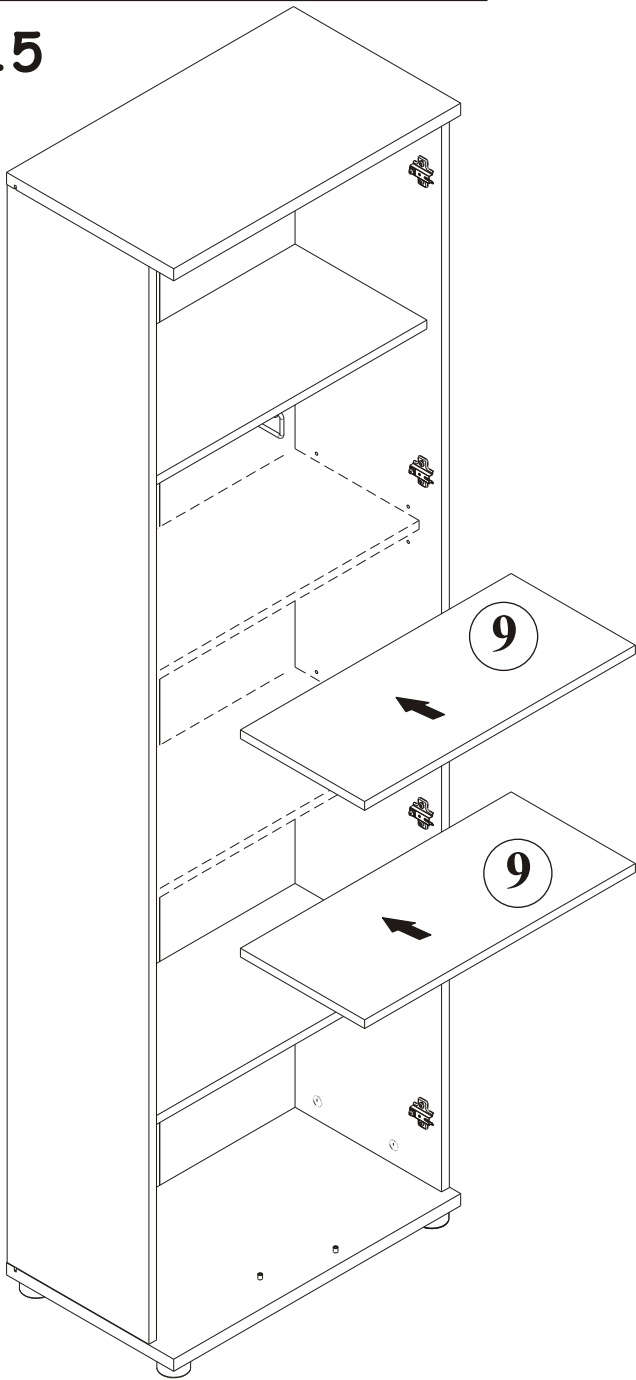

16

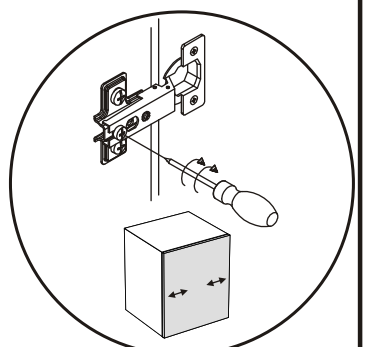
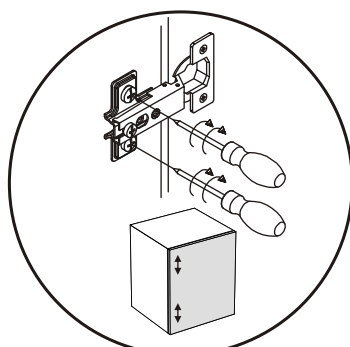
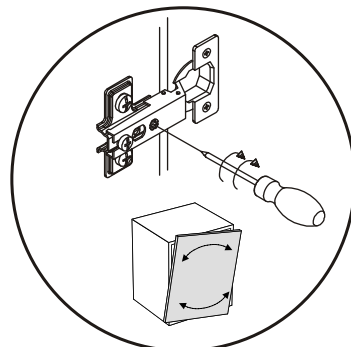
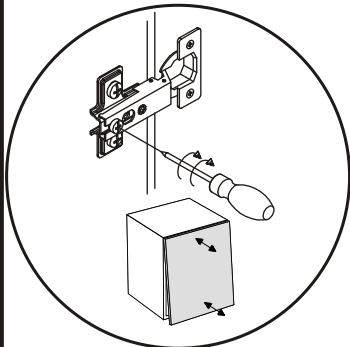
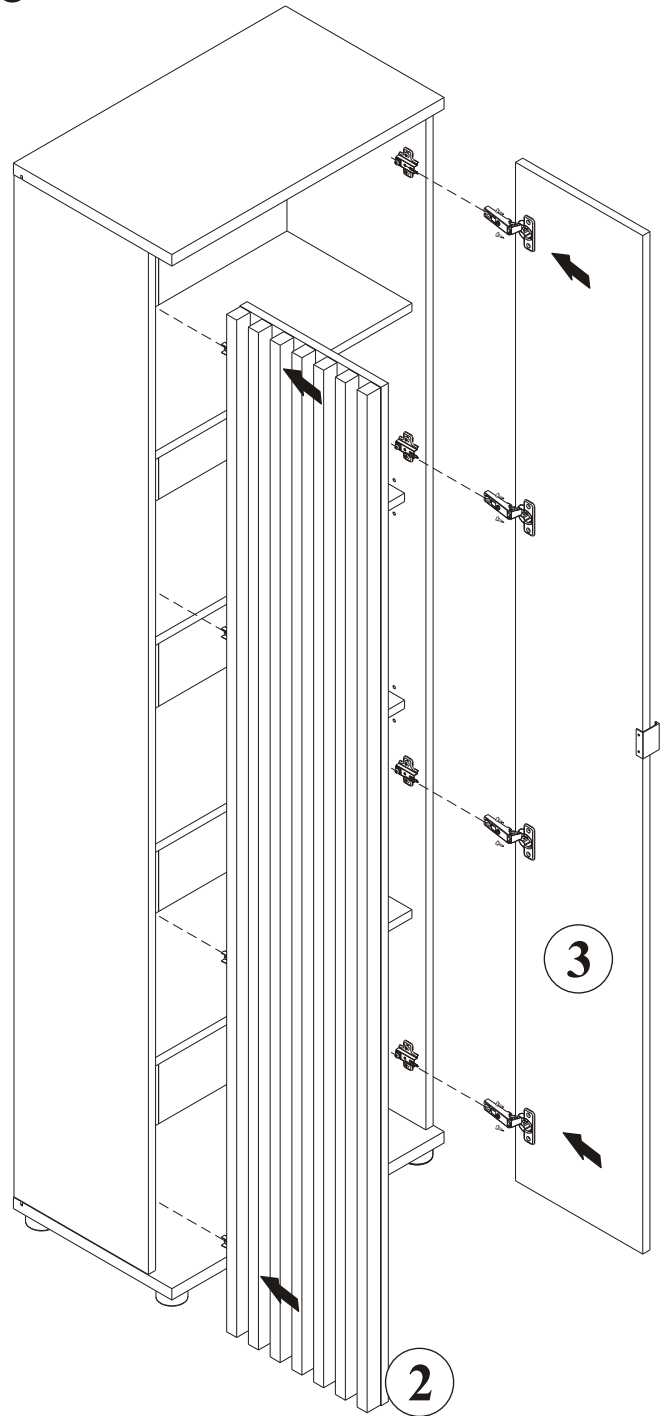

PEDRO HJZ PD ___ TYP E

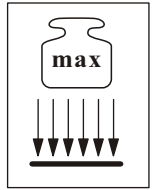
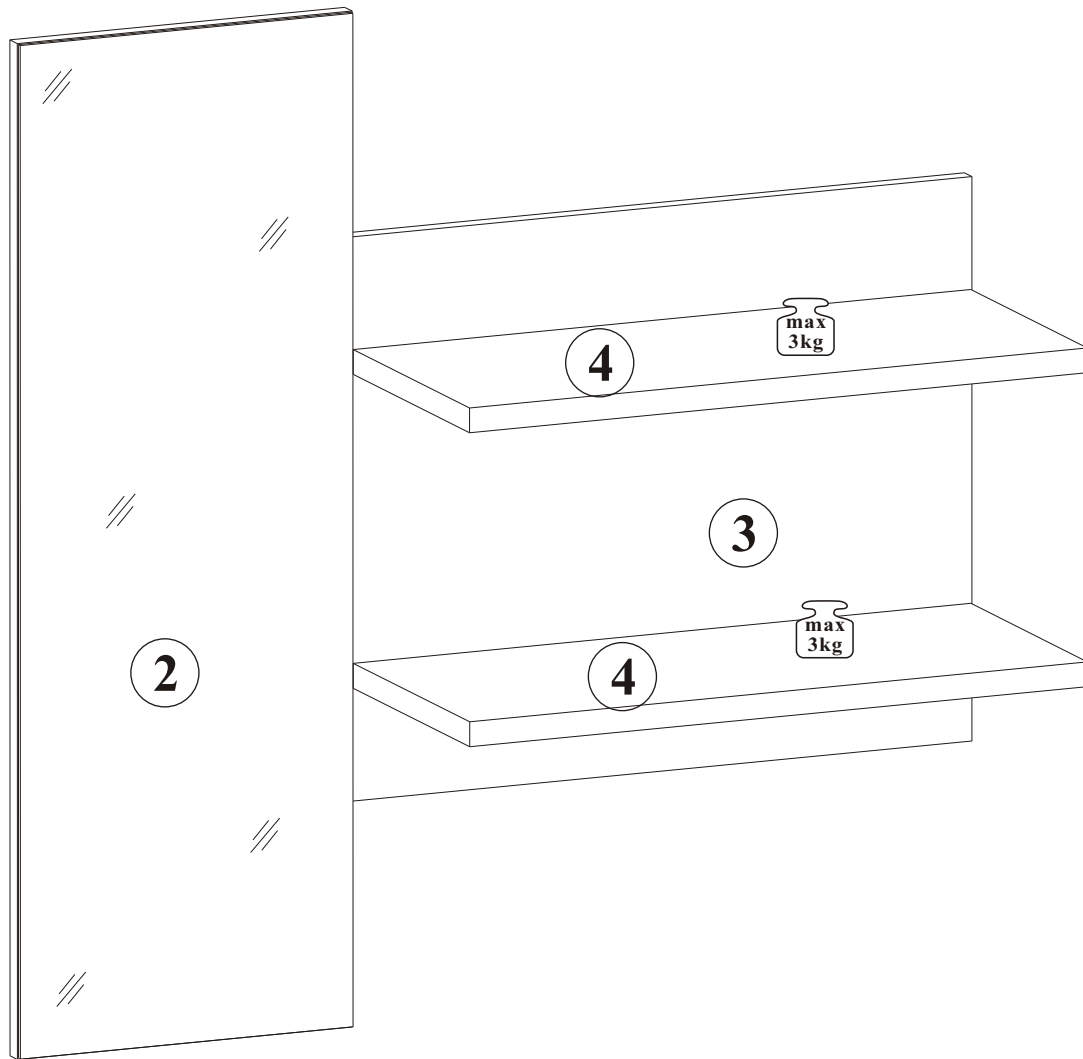

NO	DIM [mm]		COL.-NO	QTY
2	316	900	16 1/1	1
3	585	500	16 1/1	1
4	583	250	22 1/1	2

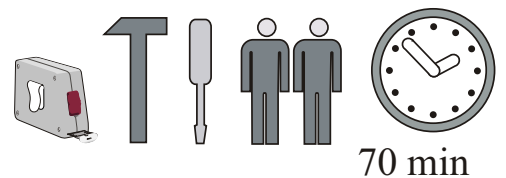



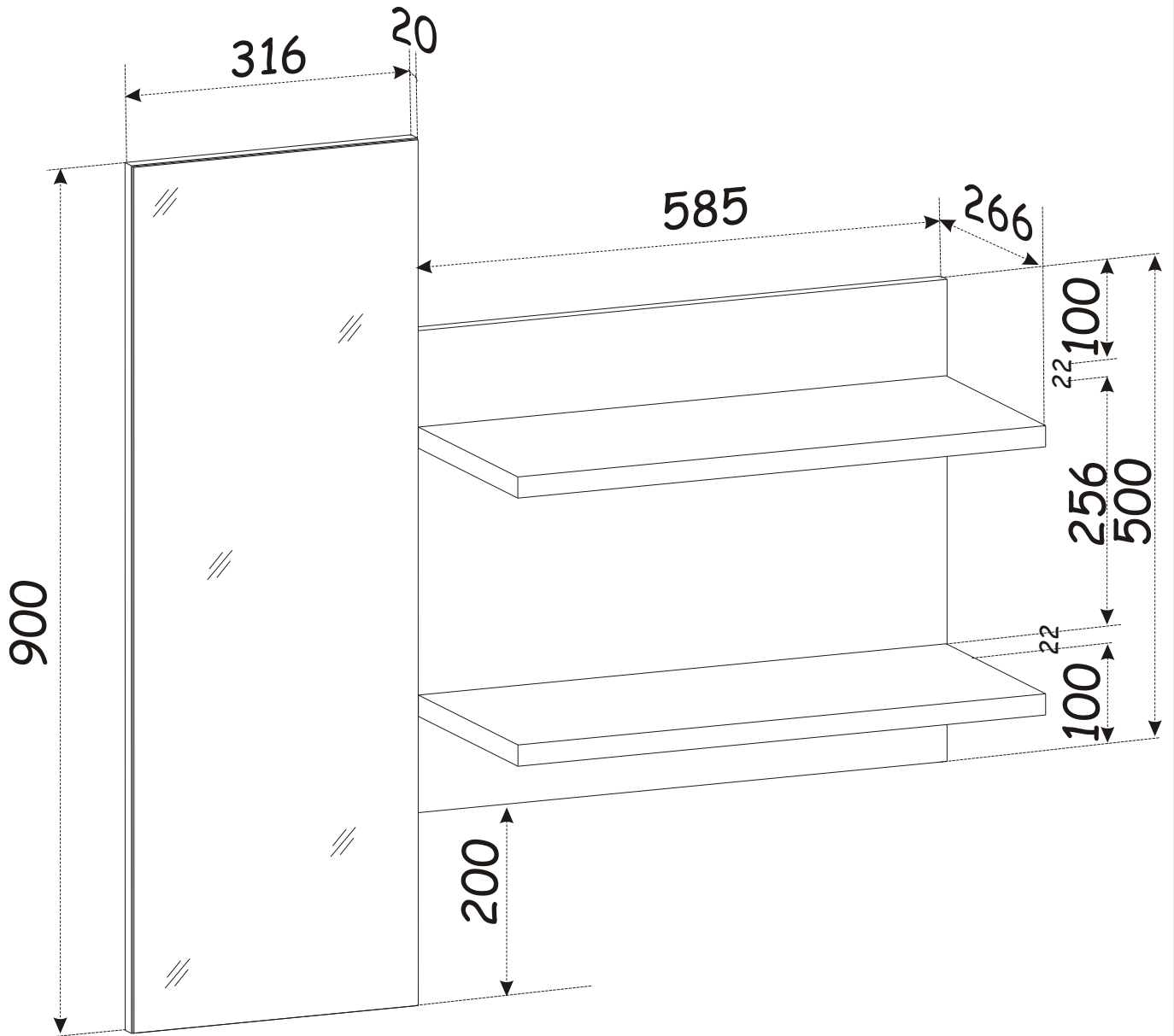

70 min

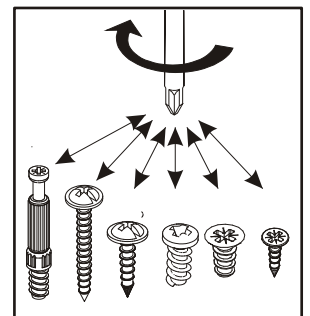
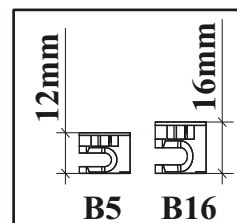
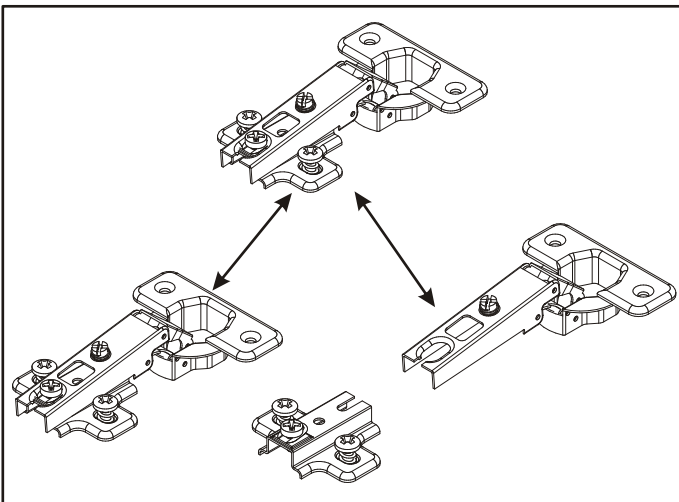
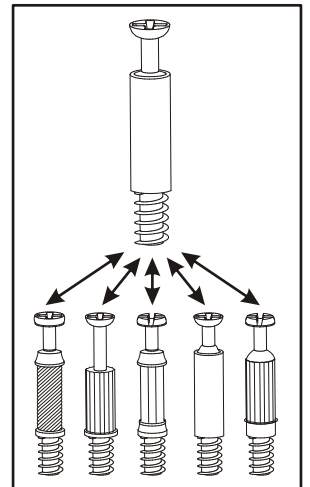
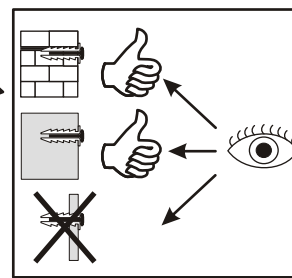
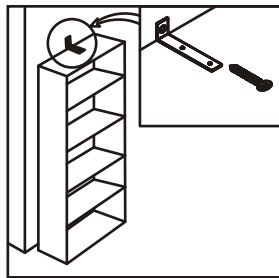
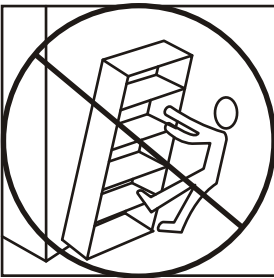
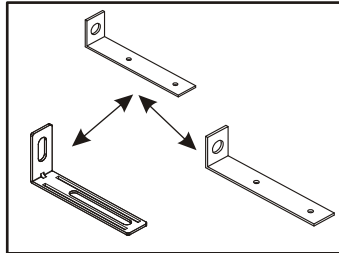
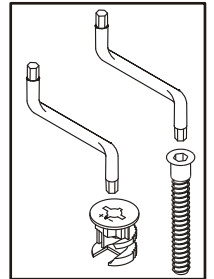
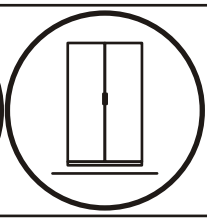
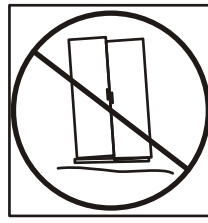
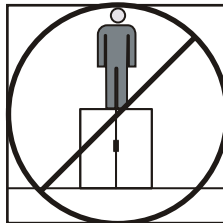
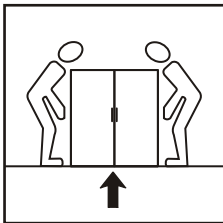
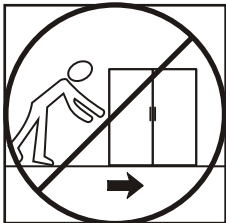
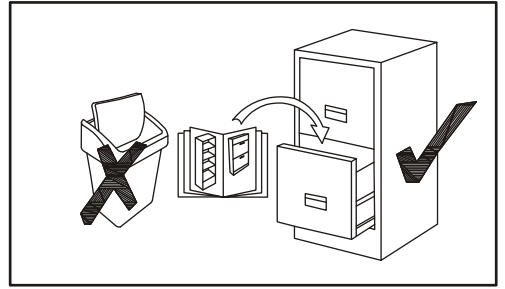
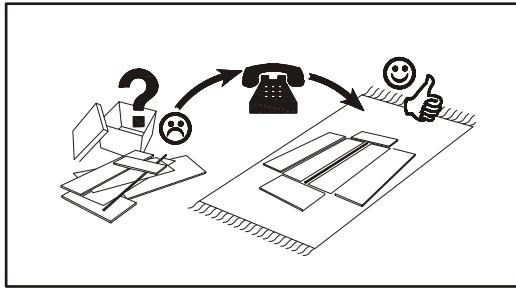
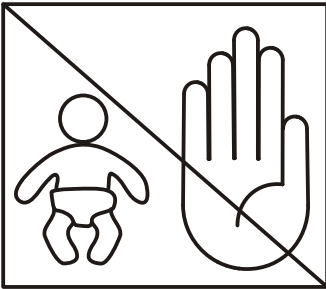
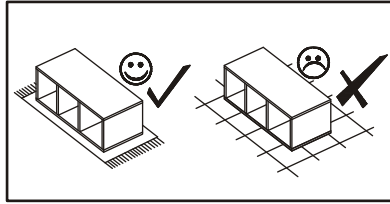
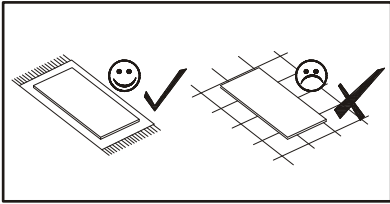
PEDRO HJZ PD _ TYP E



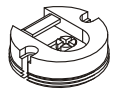
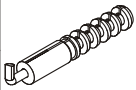

PEDRO HJZ PD _ TYP E

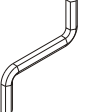
B11		G4		ZM1		KR3		D20		G2	
x10	Ø7x50	x10	C	x3		x6	Ø10	x12	ESØ6,3x9,5	x1	

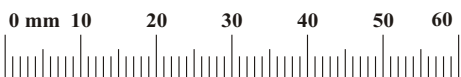

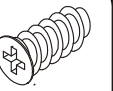
D20	
x6	ESØ6,3x9,5

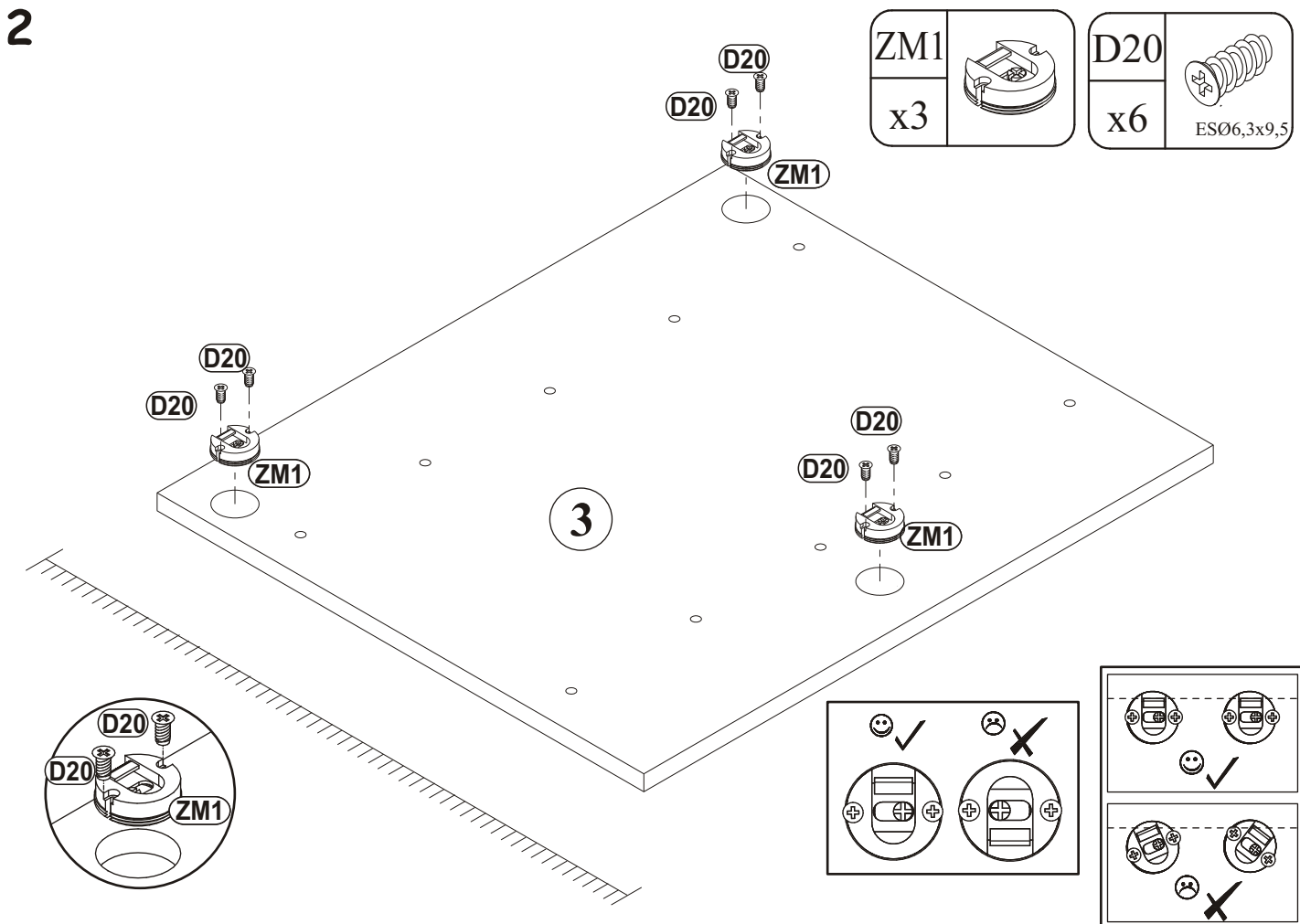
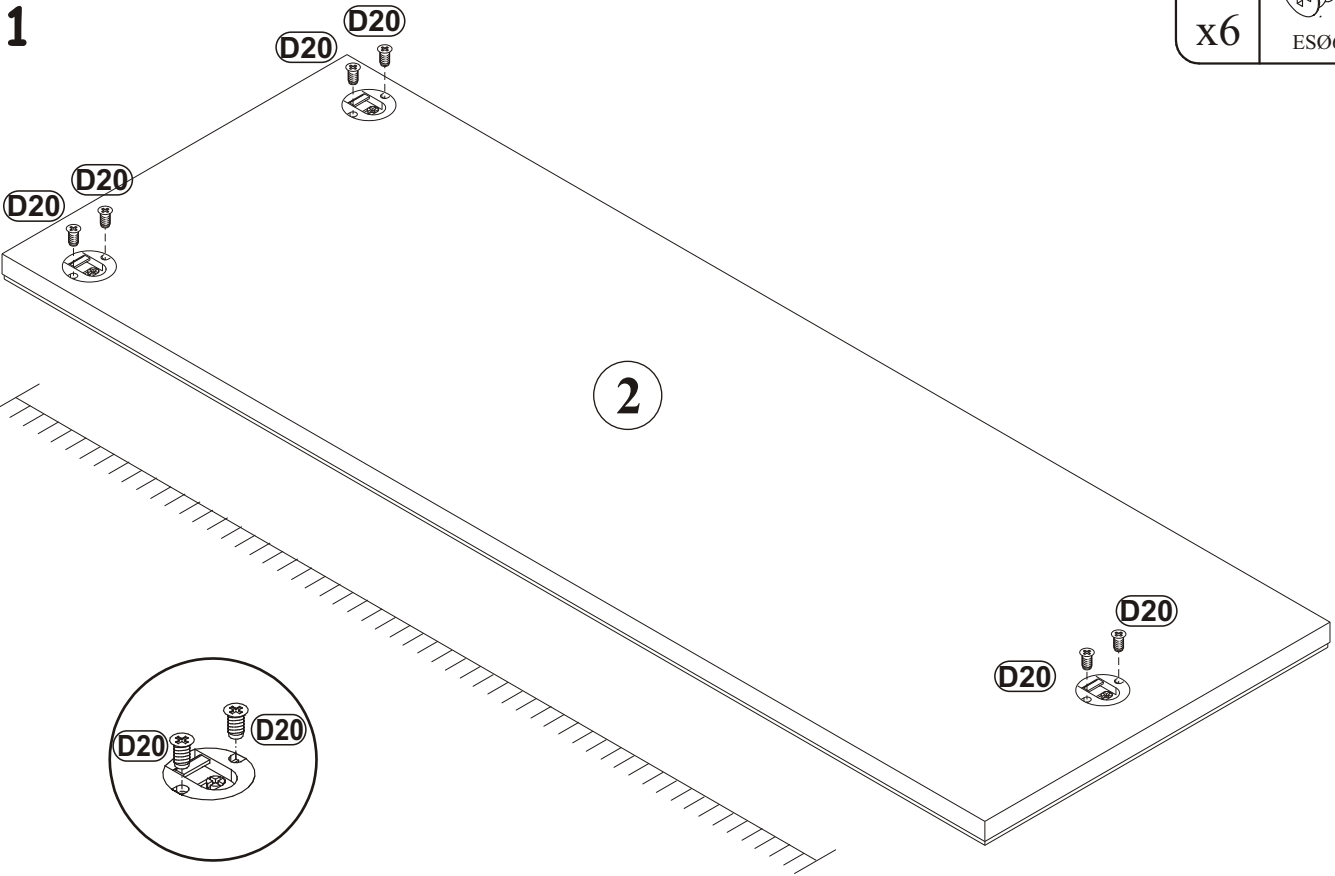

3

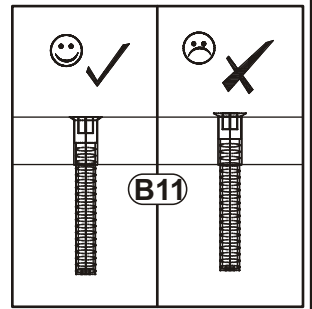
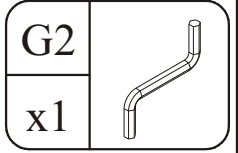
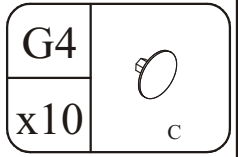
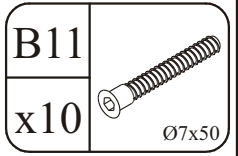
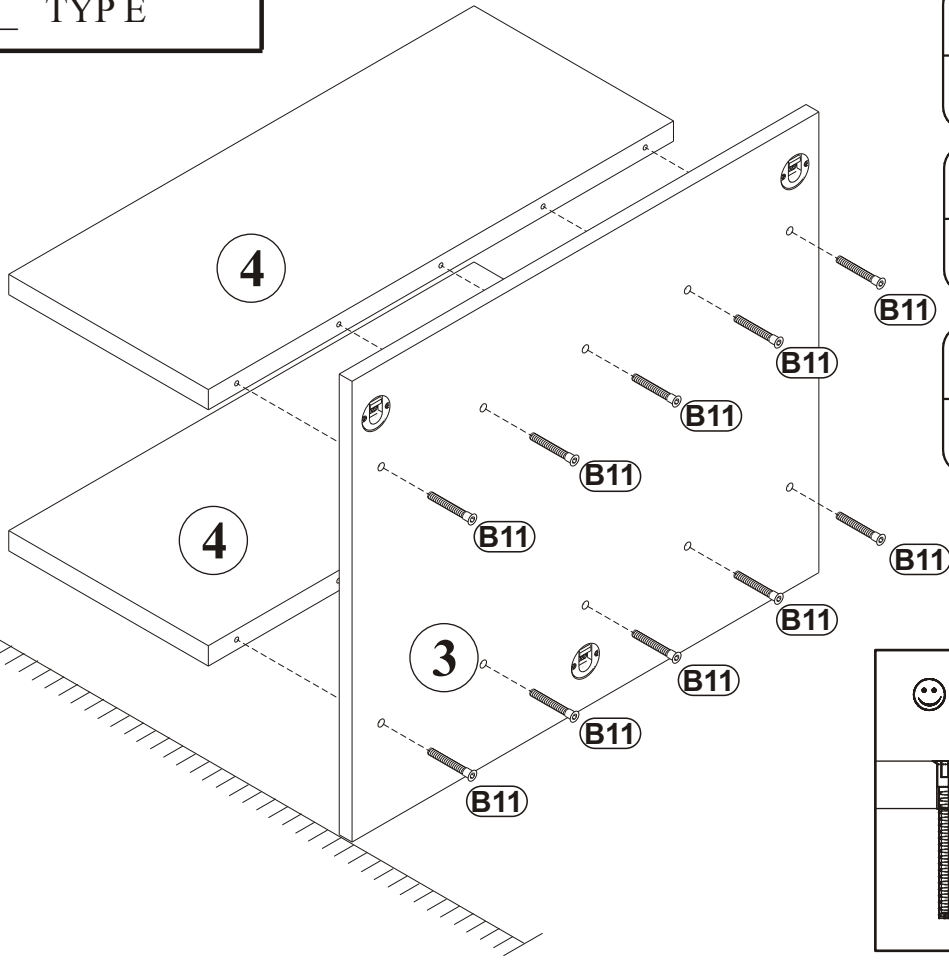
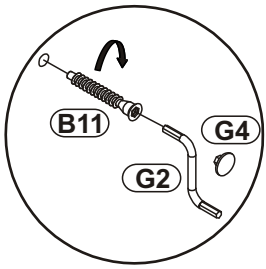

4

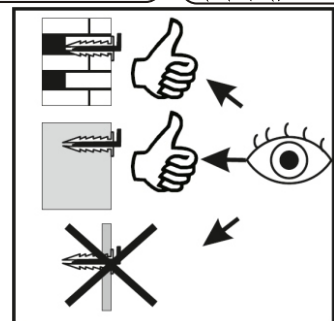
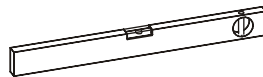
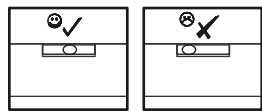
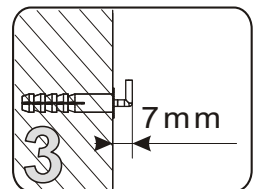
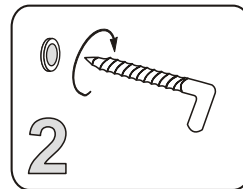
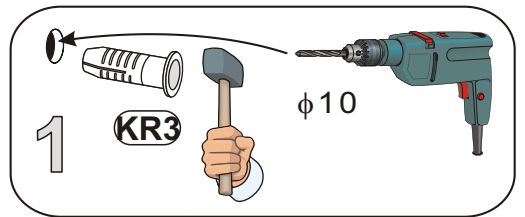
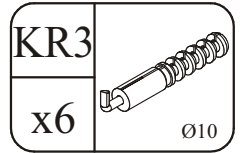
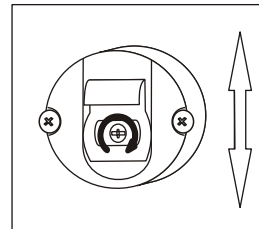
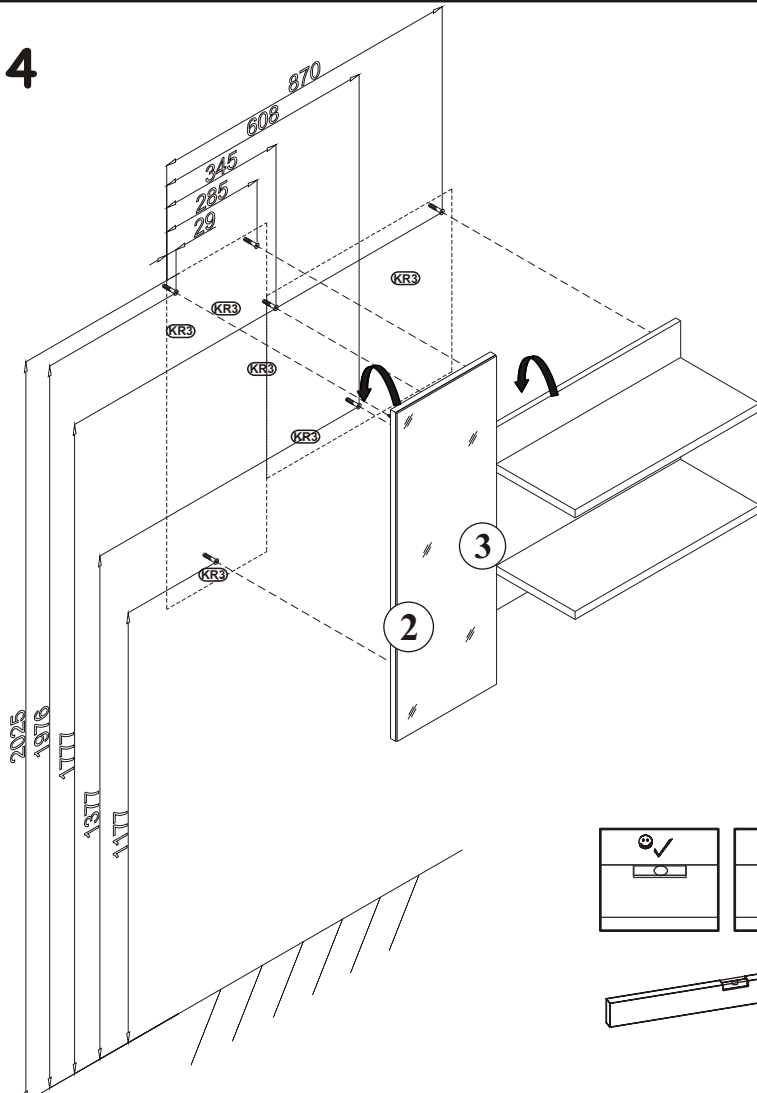

PEDRO HJZ PD __ TYP G

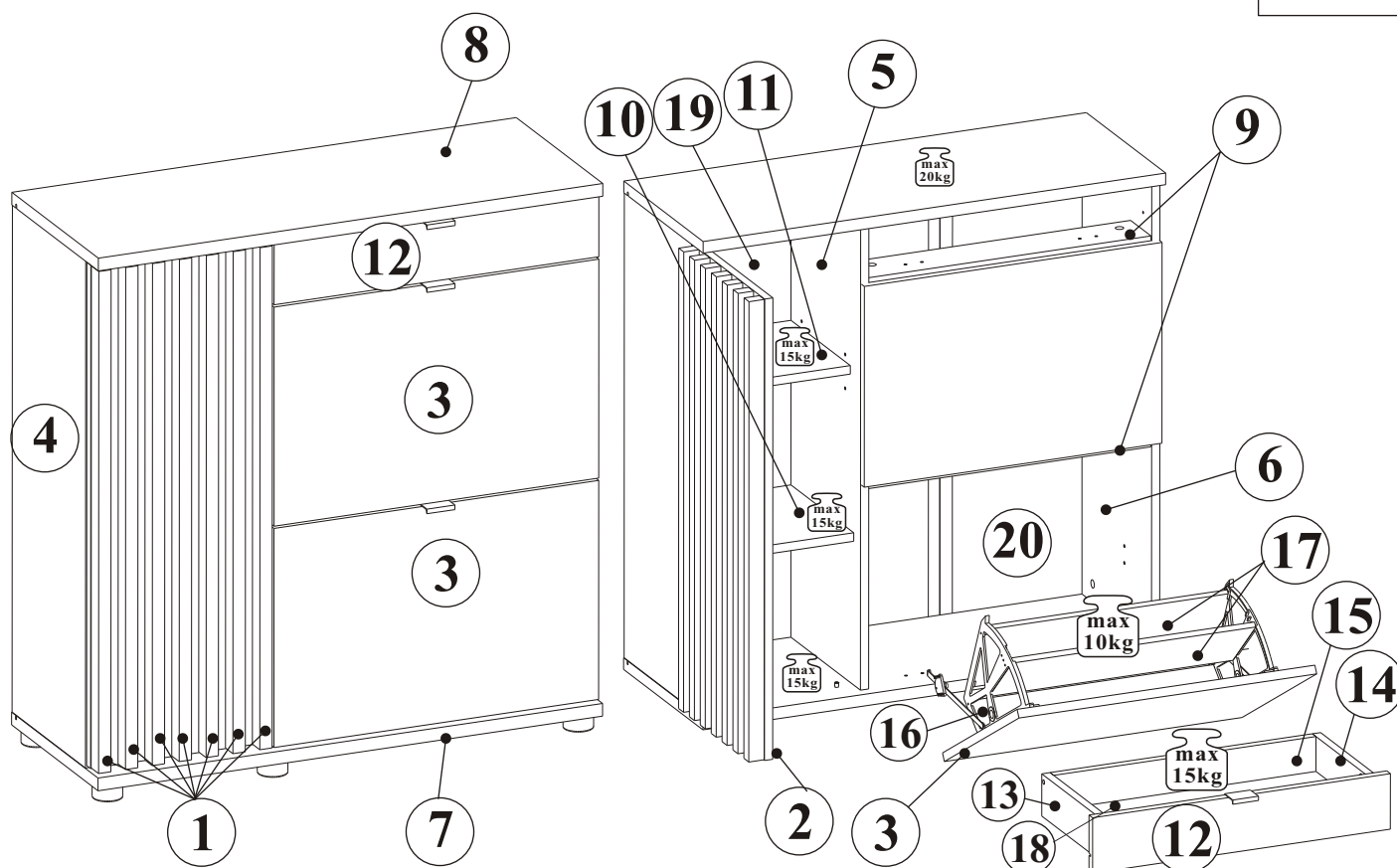
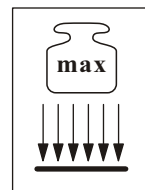

NO	DIM [mm]		COL.-NO	QTY
1	871	30	22 2/2	7
2	312	873	16 2/2	1
3	580	380	16 1/2	2
4	880	297	16 2/2	1
5	880	307	16 2/2	1
6	880	327	16 2/2	1
7	901	350	22 2/2	1
8	901	350	22 2/2	1
9	551	90	16 1/2	2
10	300	277	16 1/2	1
11	300	262	16 1/2	1
12	580	102	16 1/2	1
13	250	80	16 1/2	1
14	250	80	16 1/2	1
15	511	66	16 1/2	1
16	475	80	12 1/2	2
17	475	140	12 1/2	4
18	523	253	3 1/2	1
19	892	314	3 2/2	1
20	892	564	3 2/2	1

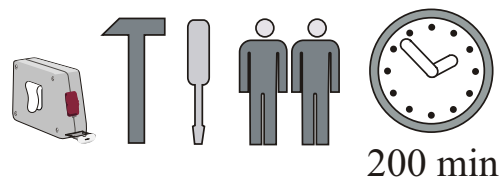



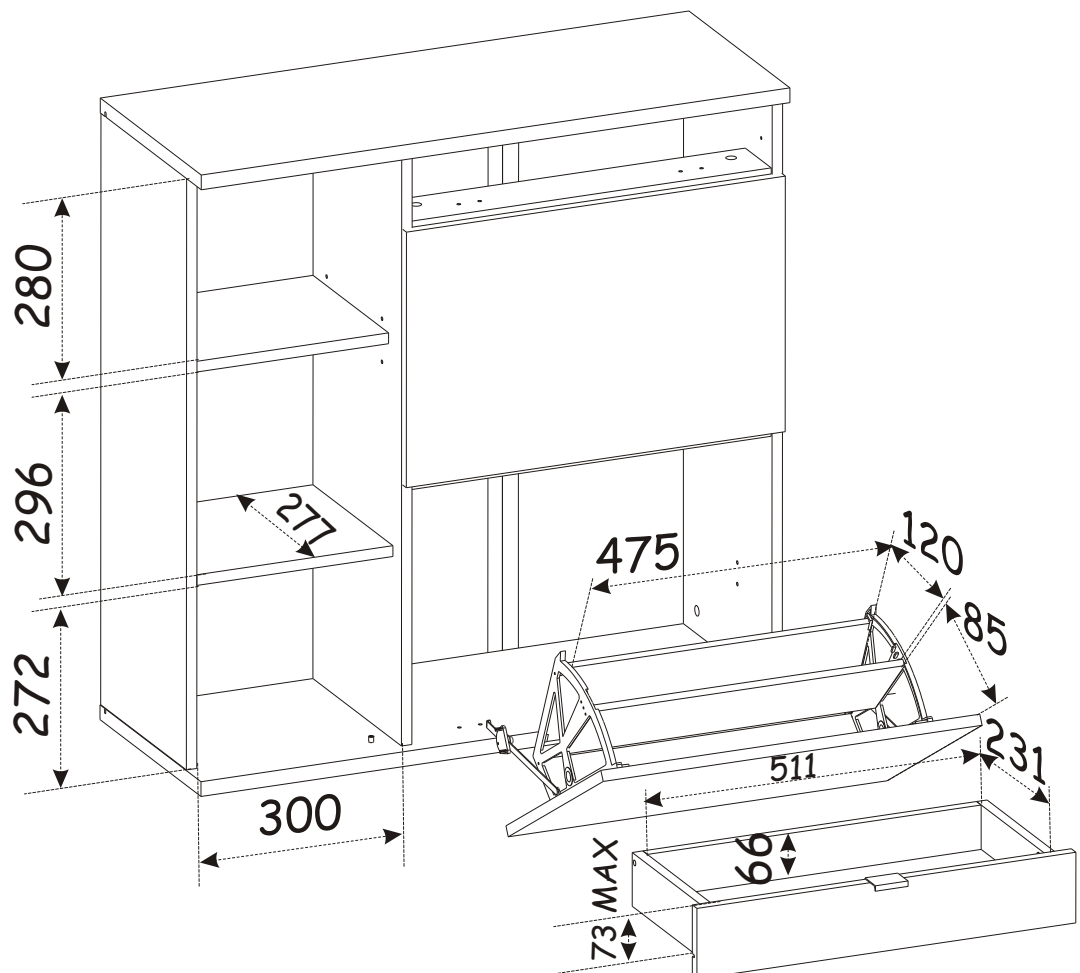
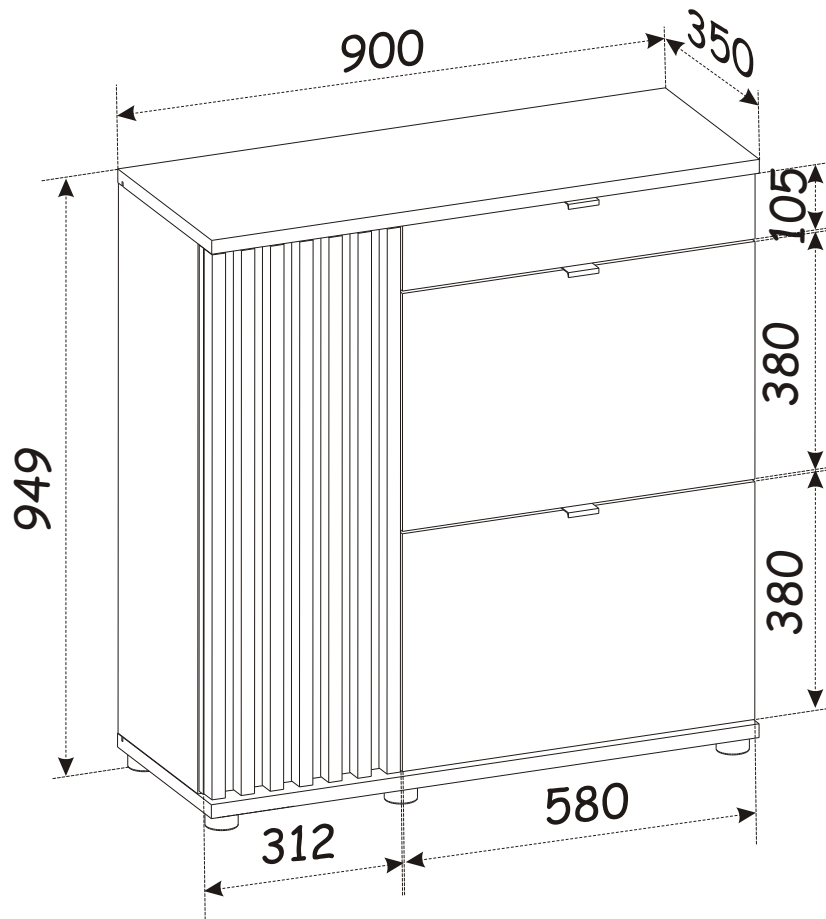

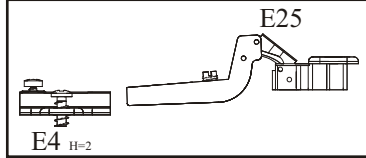
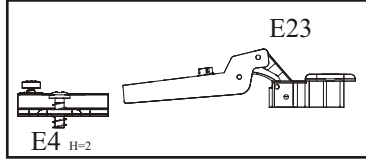
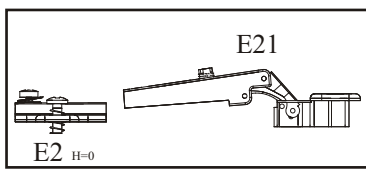
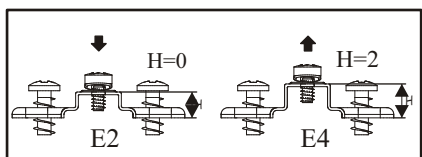
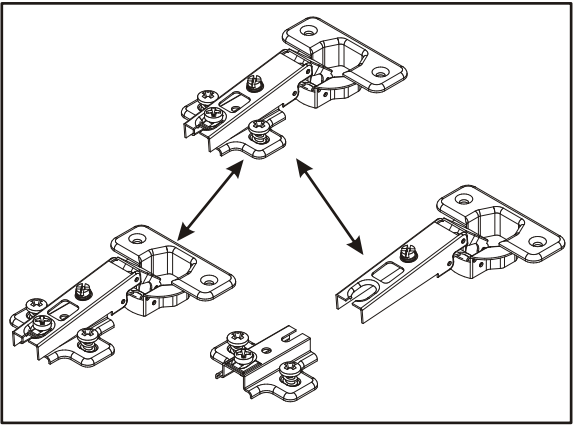
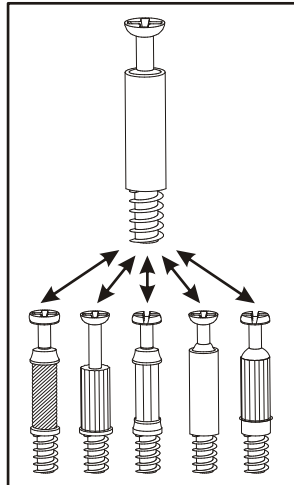
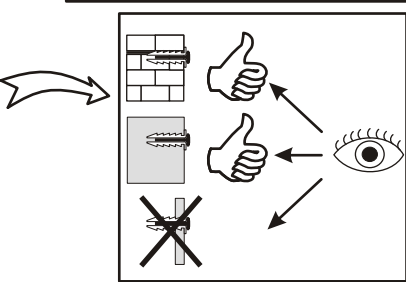
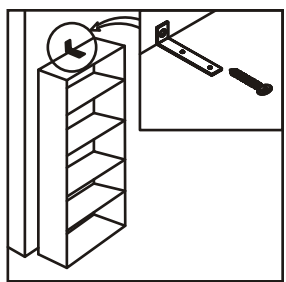
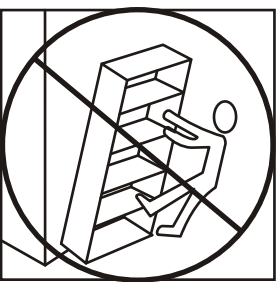
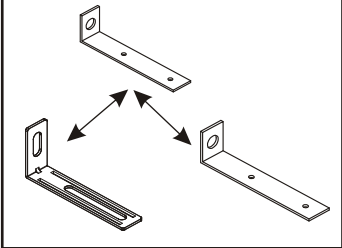
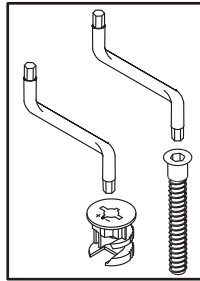
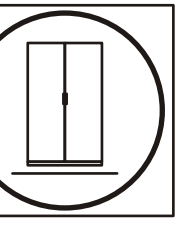
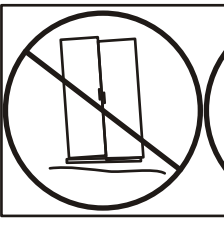
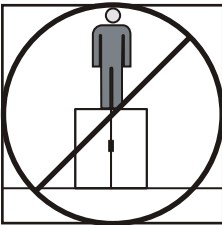
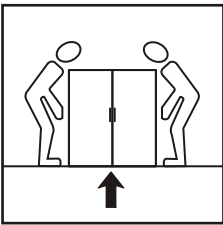
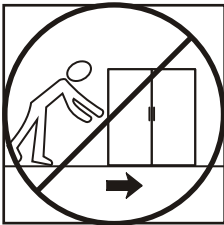
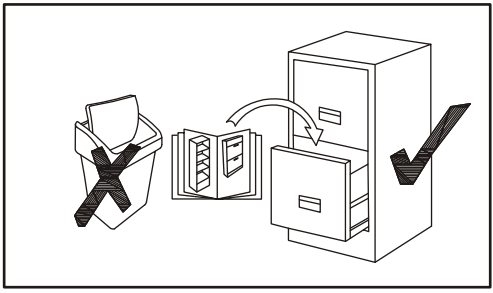
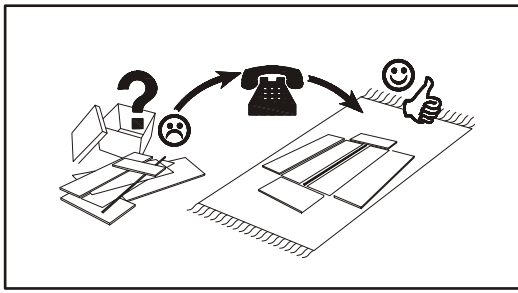
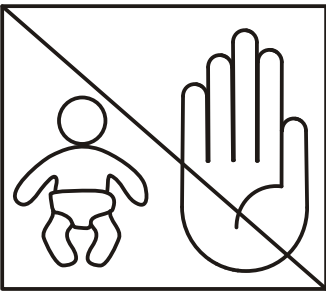
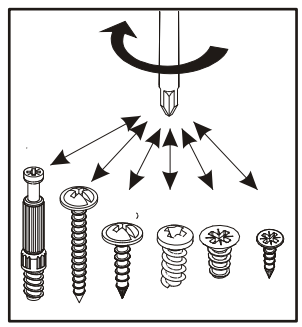
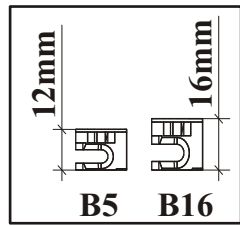
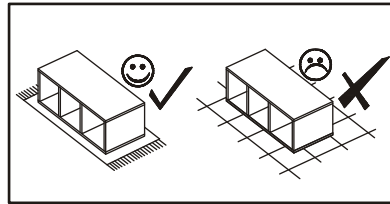
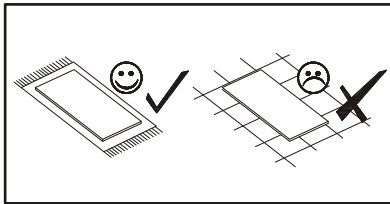



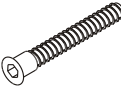

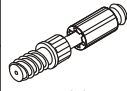



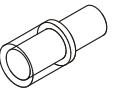
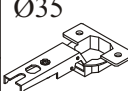
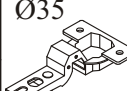
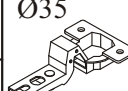
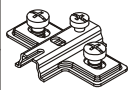
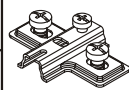
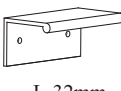

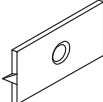
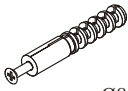
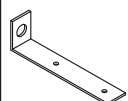
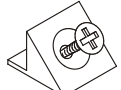
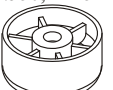
PEDRO HJZ PD _ TYP G

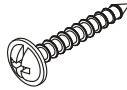
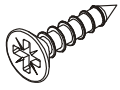

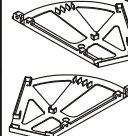

PEDRO HJZ PD __ TYP G

A1 x24 ø8x36		B11 x2 ø7x50		B22 x21 ø7x40		G4 x20		B4 x22 34		B5 x22 ø15x12	
G5 x22		G7 x4		G20 x2		E21 x2 ø35 H=0		E23 x2 ø35 H=8		E25 x2 ø35 H=16	
E2 x2 H=0		E4 x4 H=2		G02 x3 L-32mm.		G21 x4		G16 x6		KR1 x2 ø8	
L1 x2		S1 x14		ST7 x6 ø50, h=25		QU1 x1 L-250mm		UP17 x6 UPø4x25		D7 x12 USø3x16	
D10 x34 USø3,5x13		UP9 x38 UPø3,5x16		D20 x4 ESø6,3x9,5		BU2 x2		G2 x1		G12 x3 ø14	

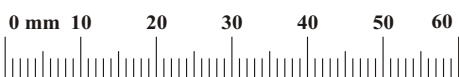

PEDRO HJZ PD __ TYP G

G12		B22		G4	
x3	Ø14	x21	Ø7x40	x18	

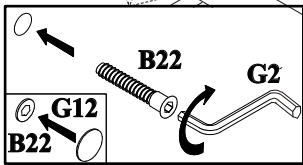
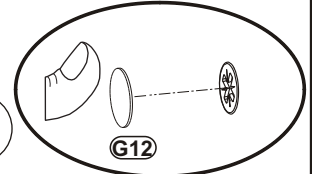
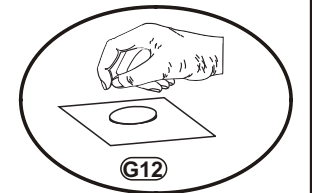
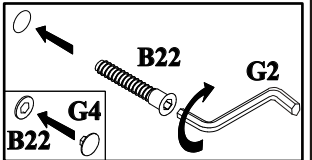
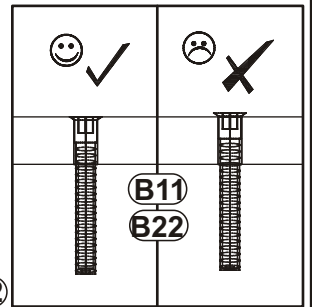
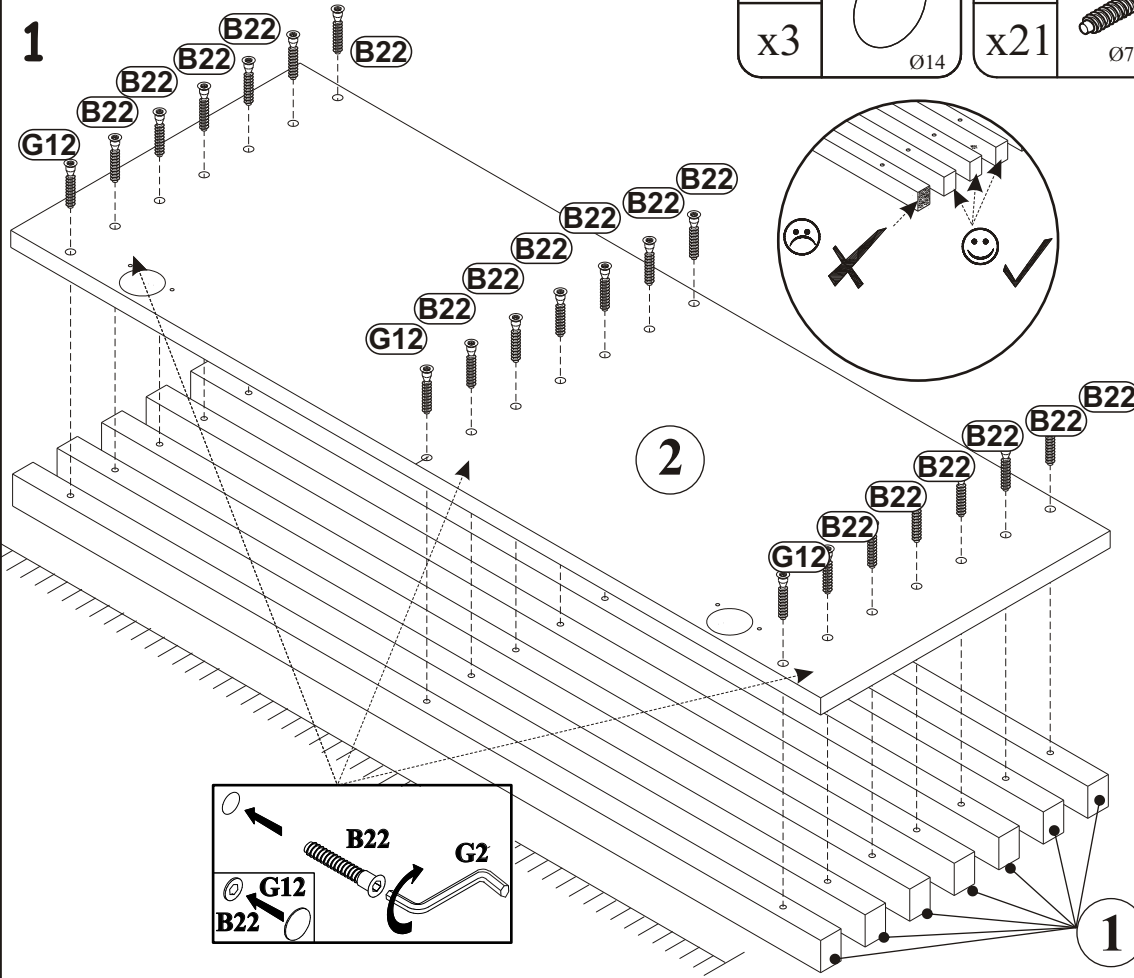

2

D10		E21	
x4	USØ3,5x13	x2	Ø35 H=0

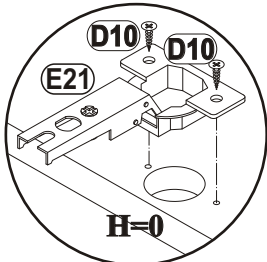
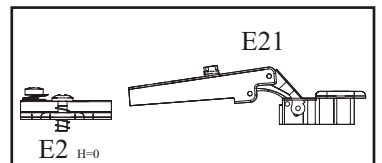
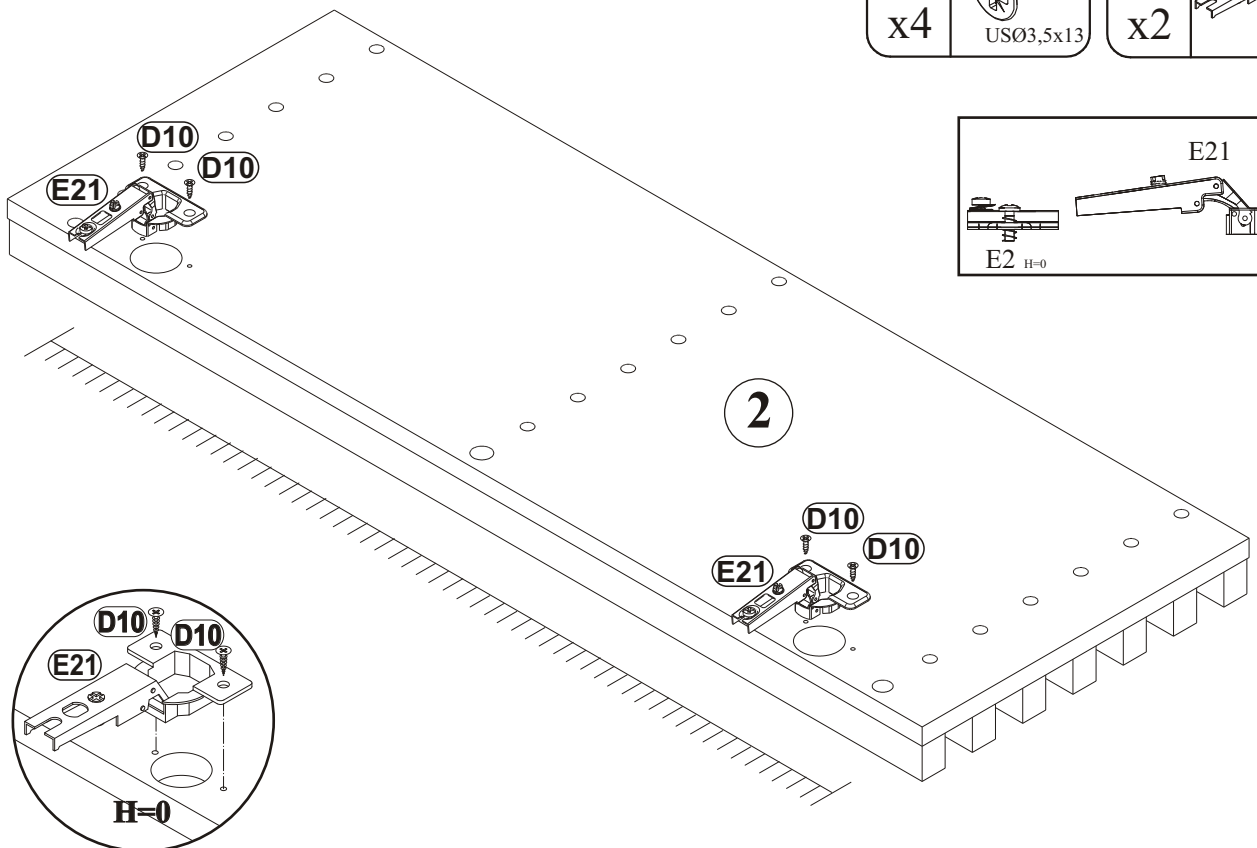

3

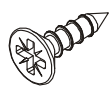
D10	
x8	USØ3,5x13

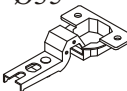
E23	Ø35	
x2	H=8	

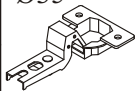
E25	Ø35	
x2	H=16	

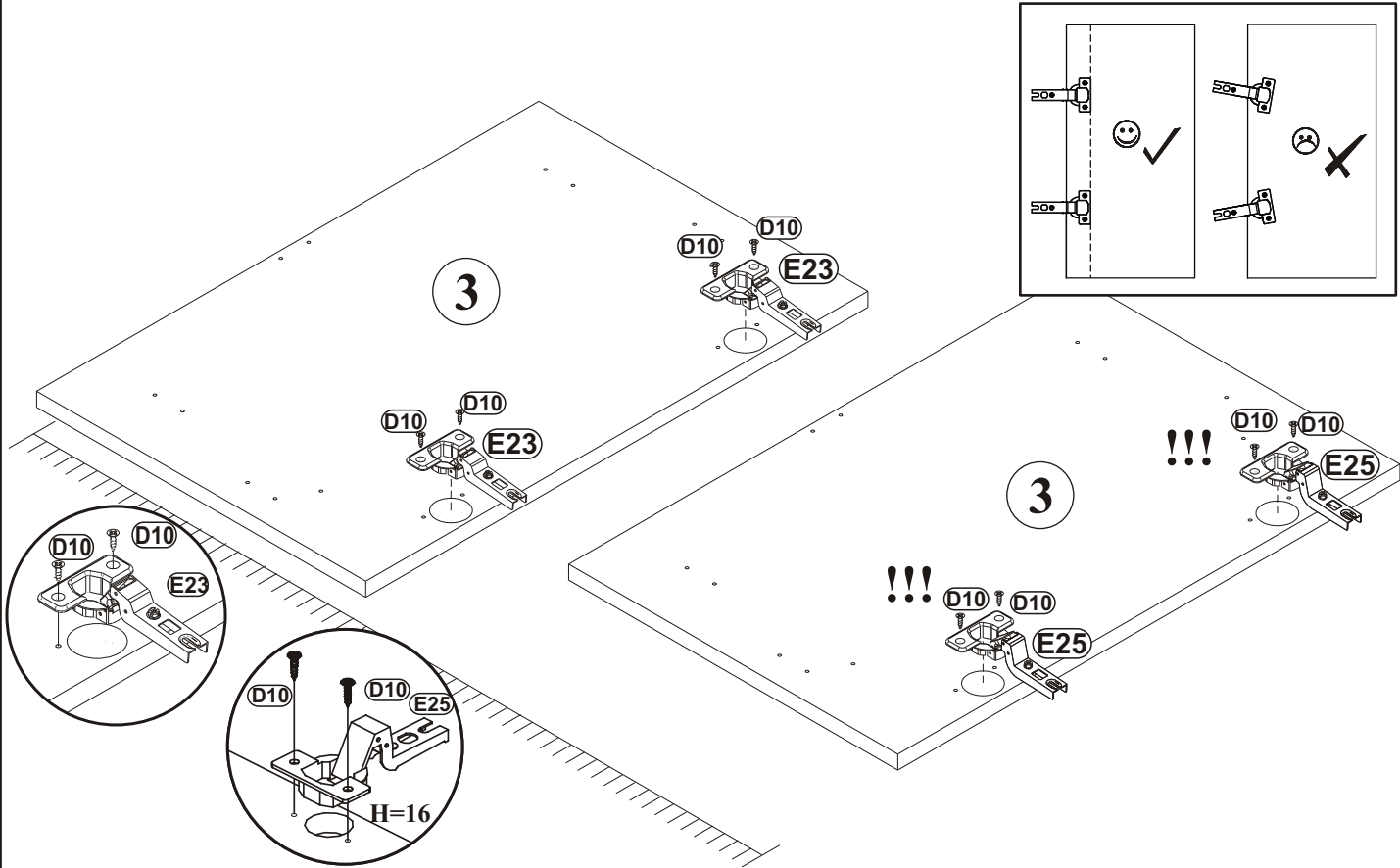

4

UP9	
x12	UPØ3,5x16

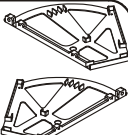
BU2	
x2	

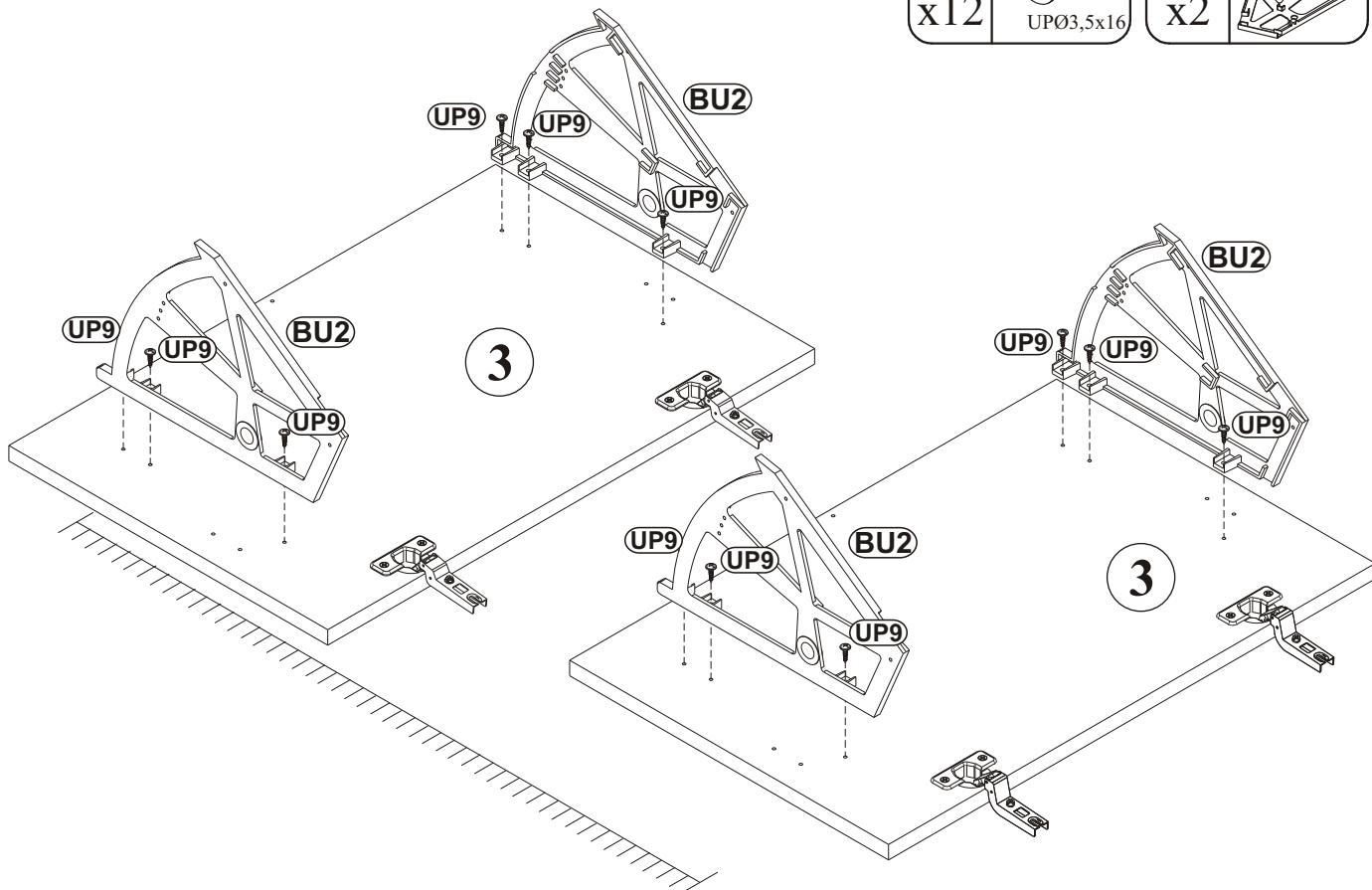

5

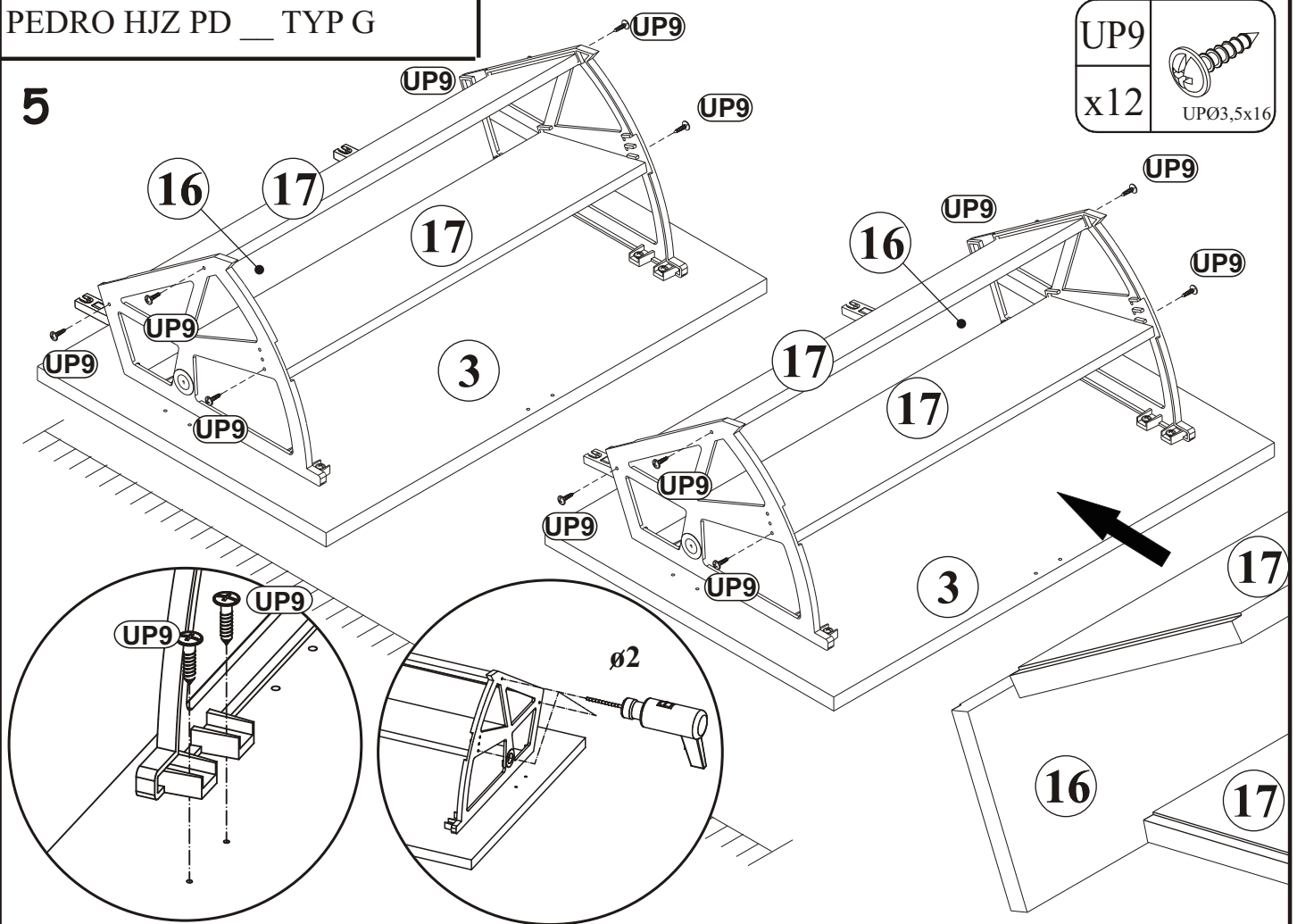

UP9	
x12	UP $\varnothing 3,5 \times 16$

6

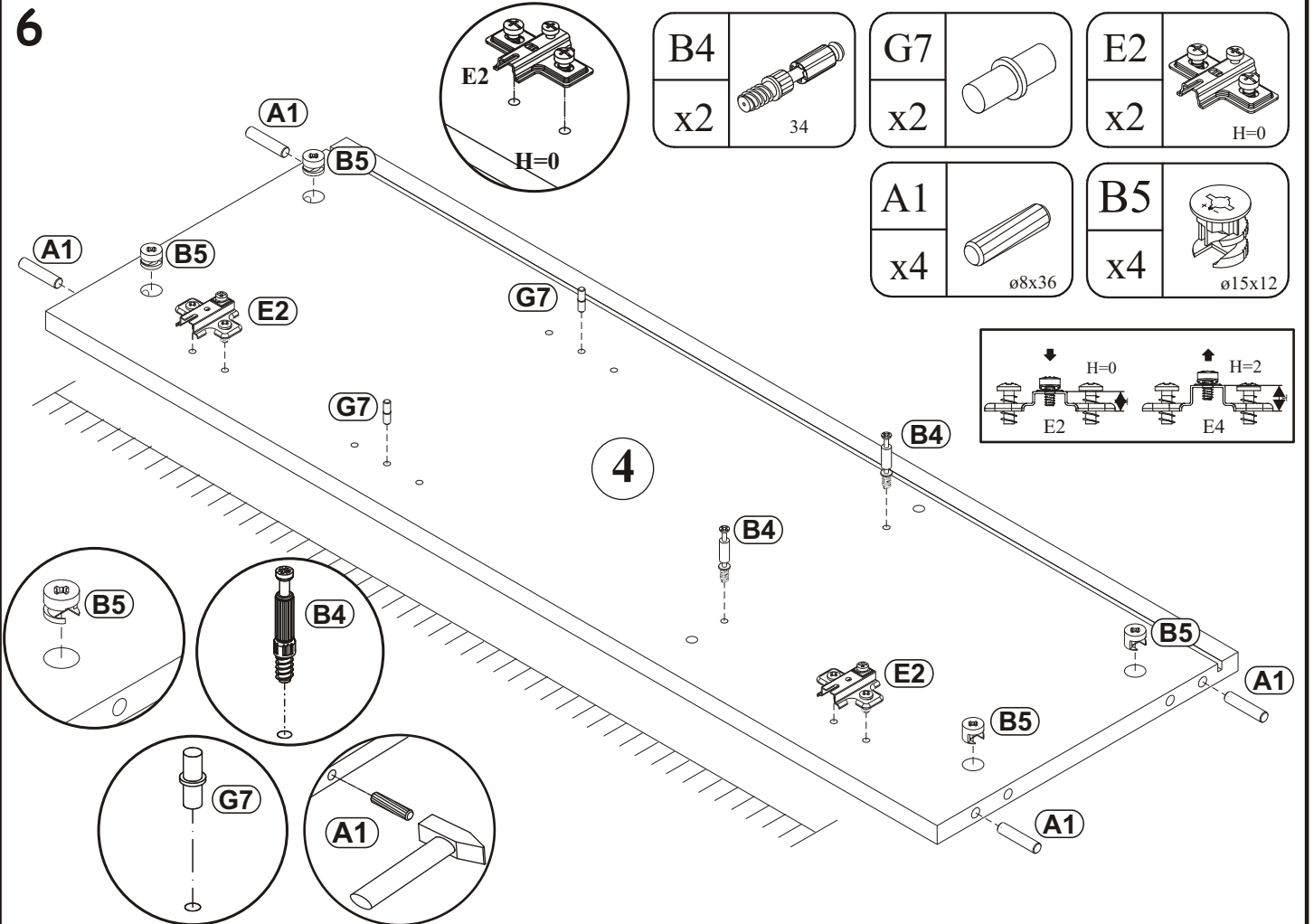

PEDRO HJZ PD __ TYP G

9

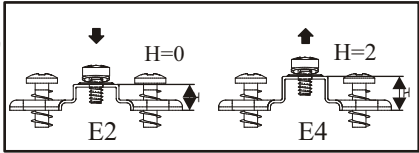

G20	
x1	

B4	
x6	34

E4	
x2	H=2

UP17	
x6	UPØ4x25

ST7	
x6	Ø50, h=25

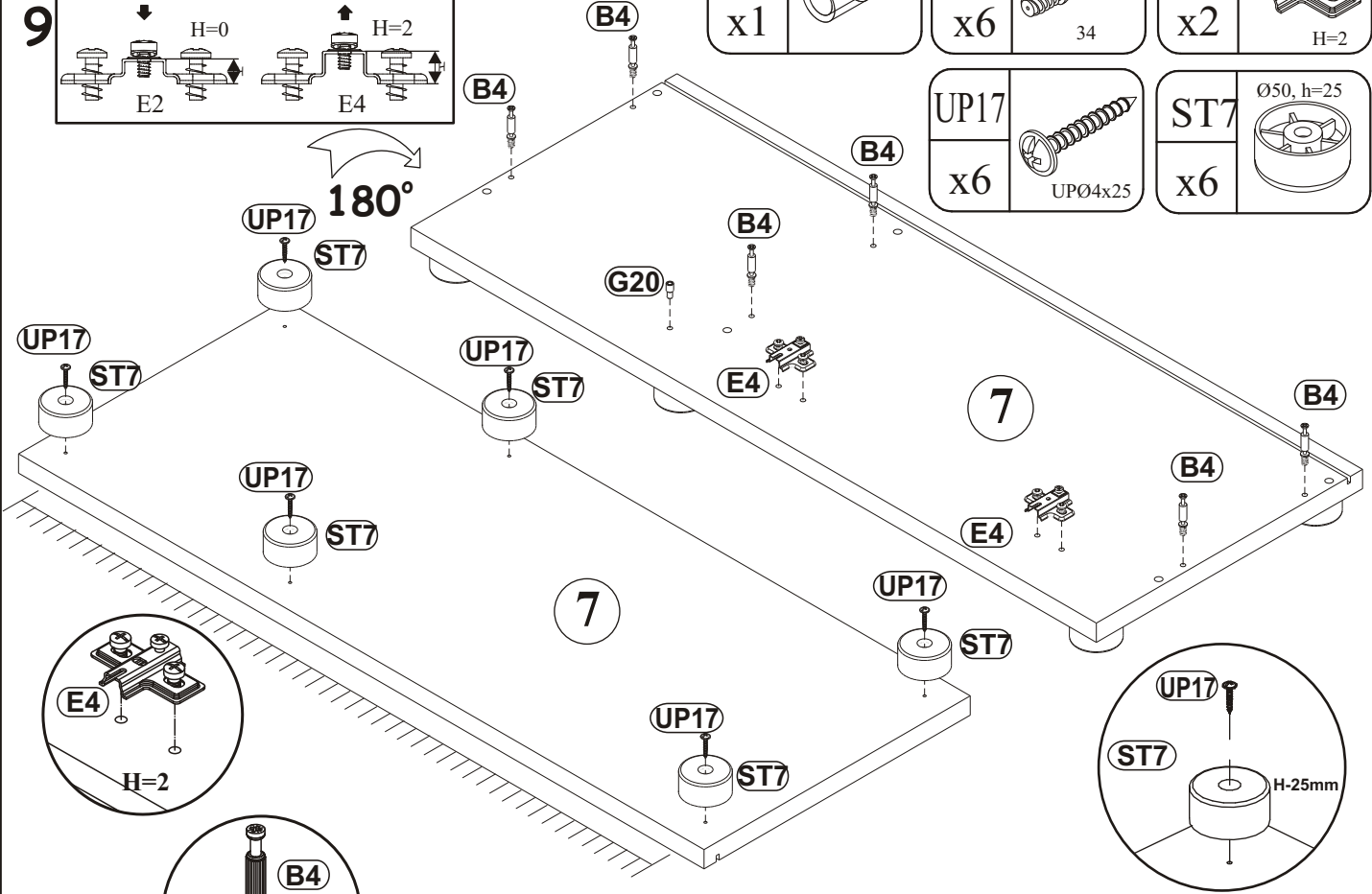

10

G20	
x1	

B4	
x6	34

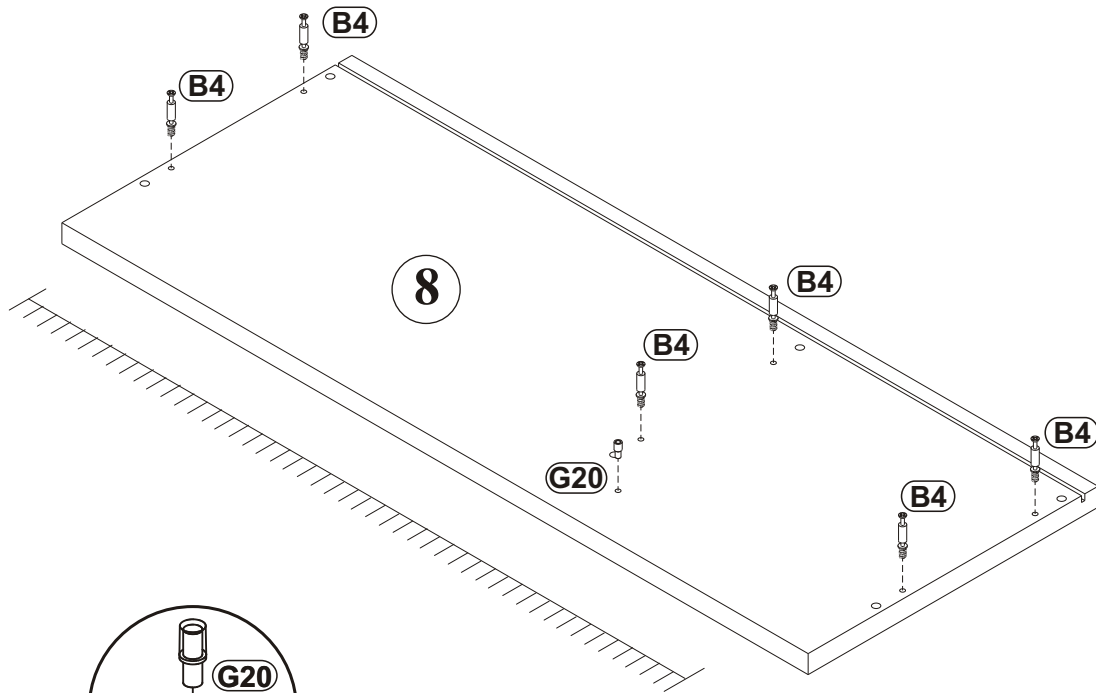

11

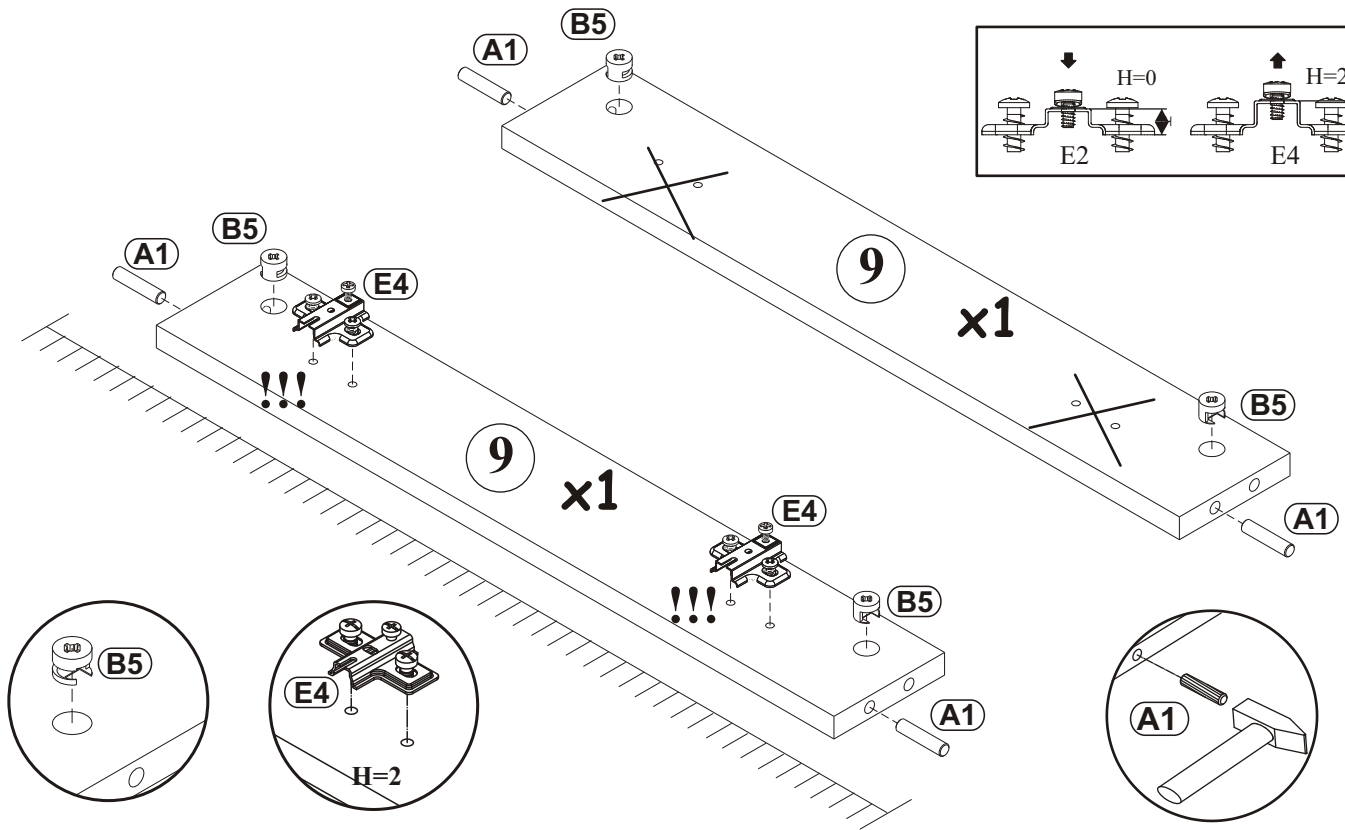
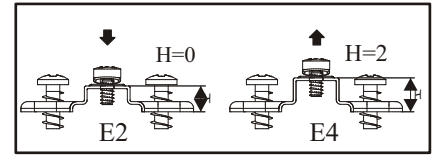
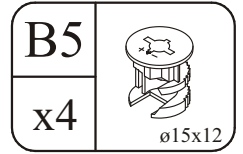
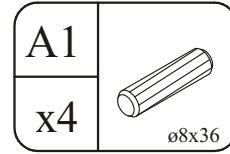
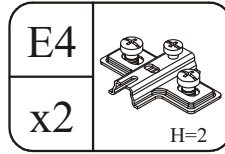

12

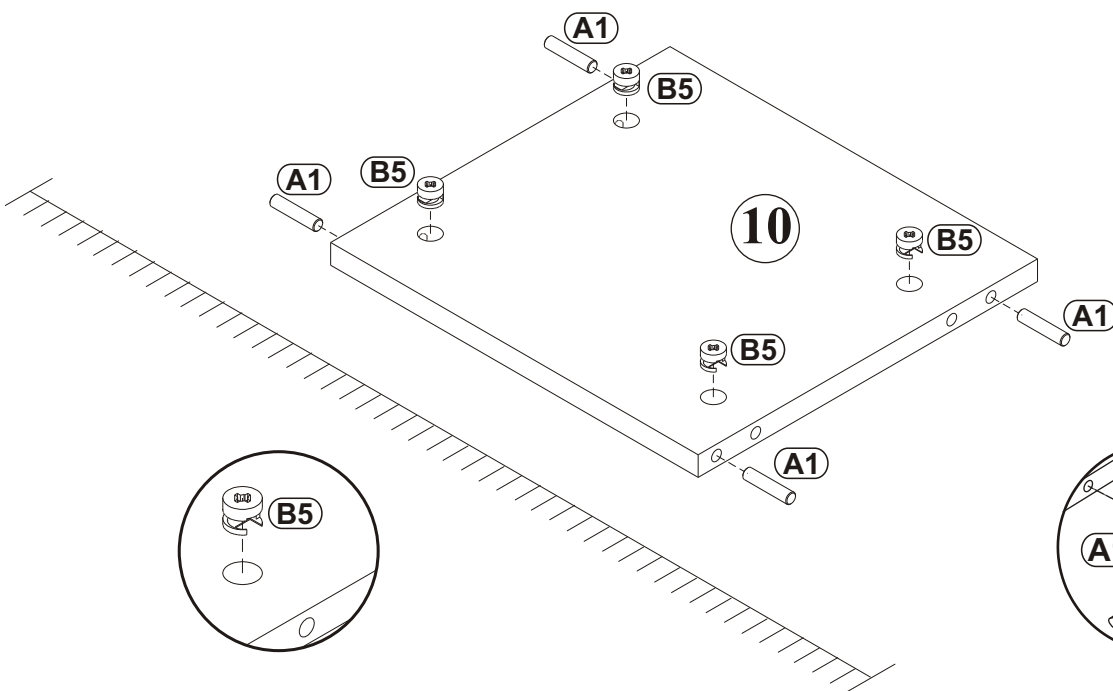
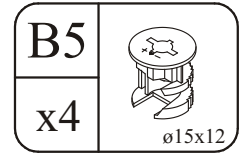
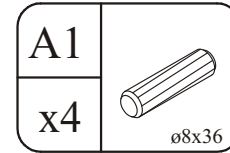

13

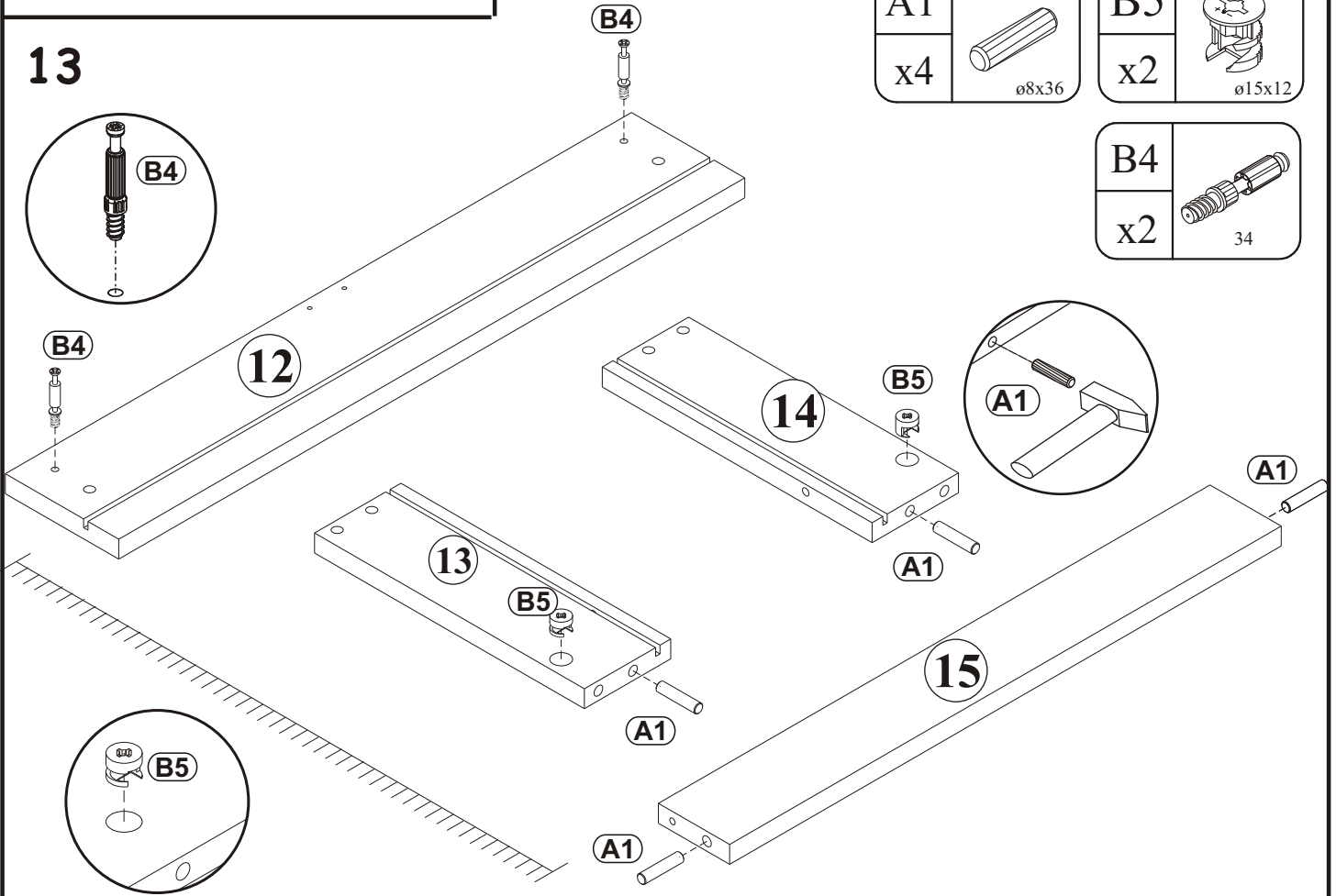

14

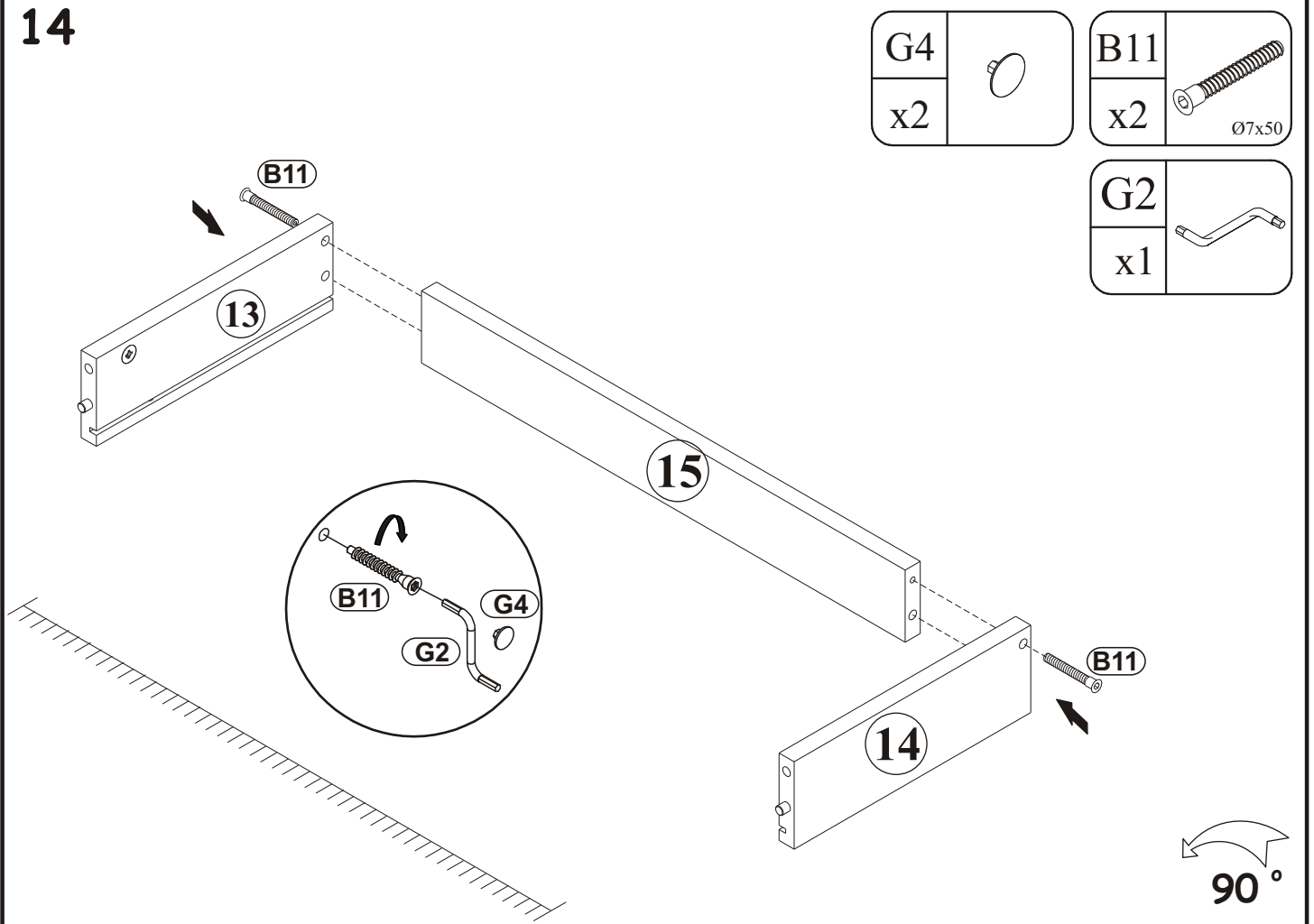

G5		G2	
x2		x1	

15

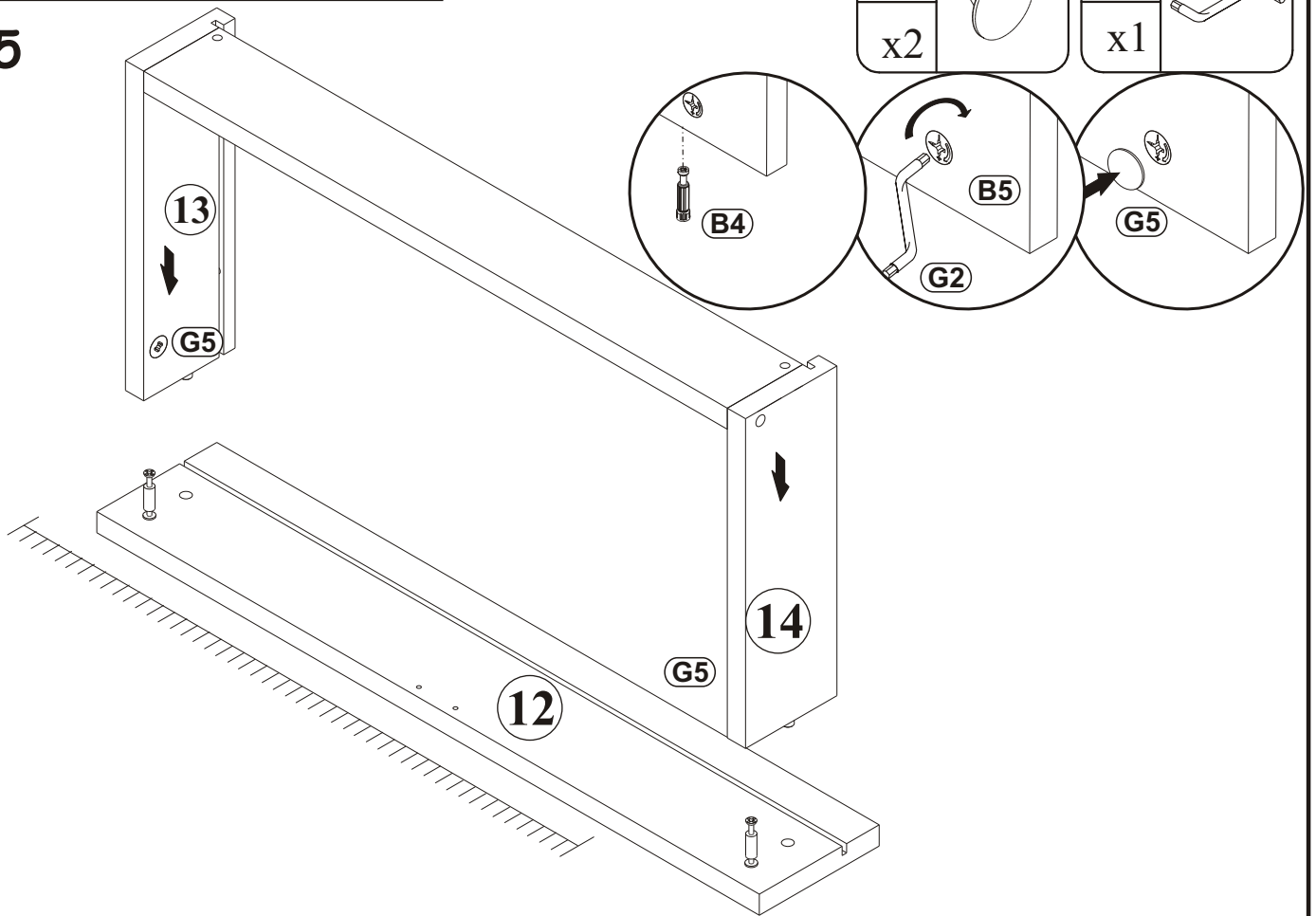

16

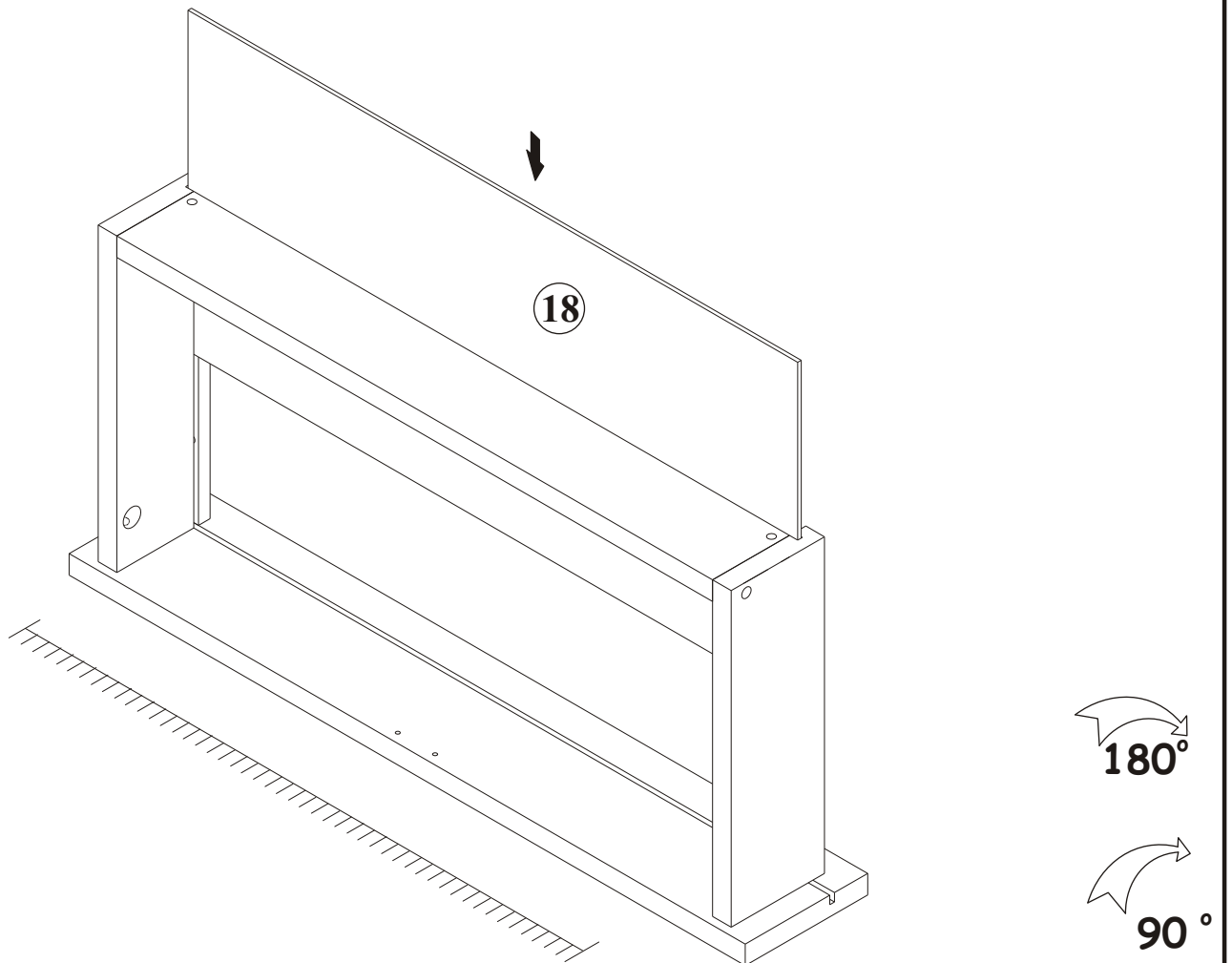

19

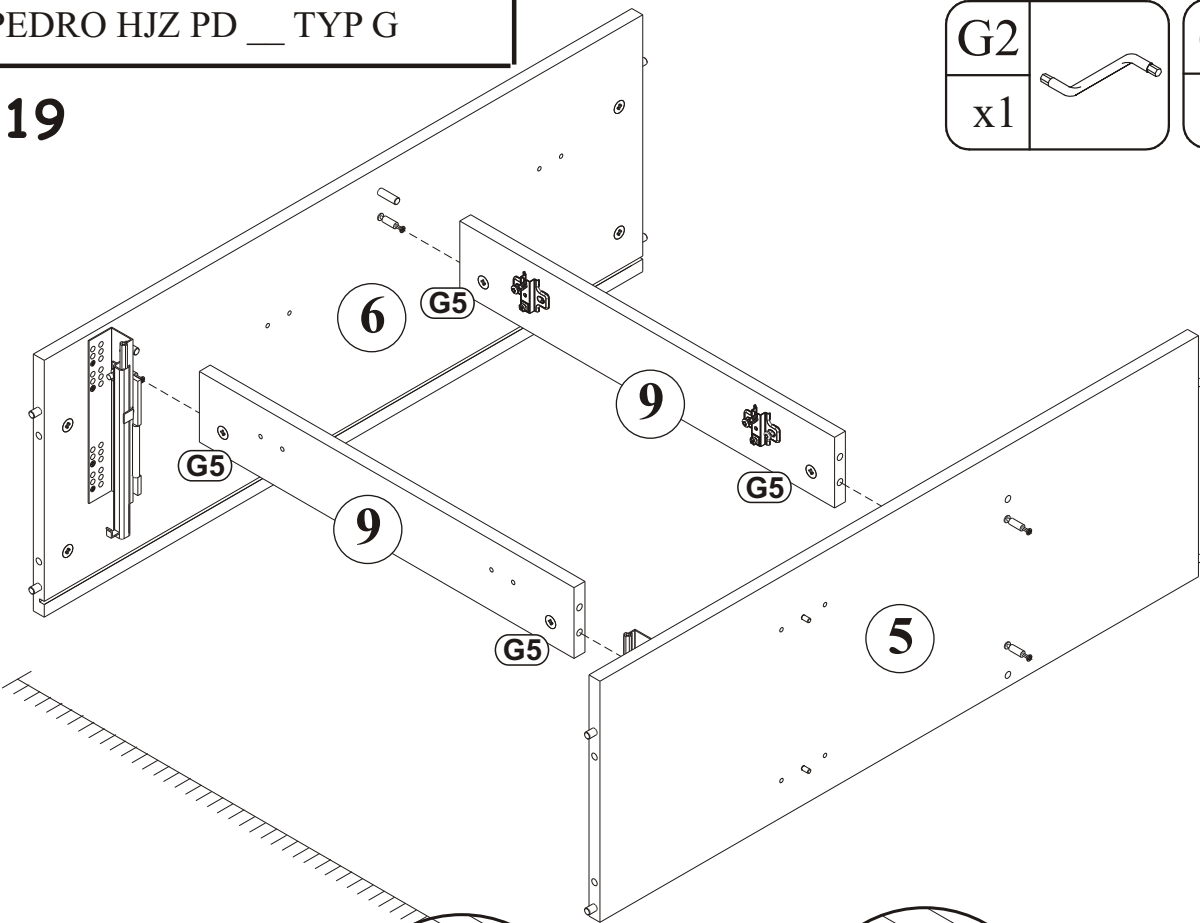

G2	
x1	

G5	
x4	

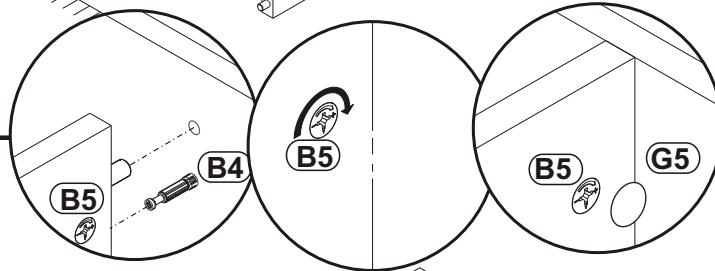

90°

20

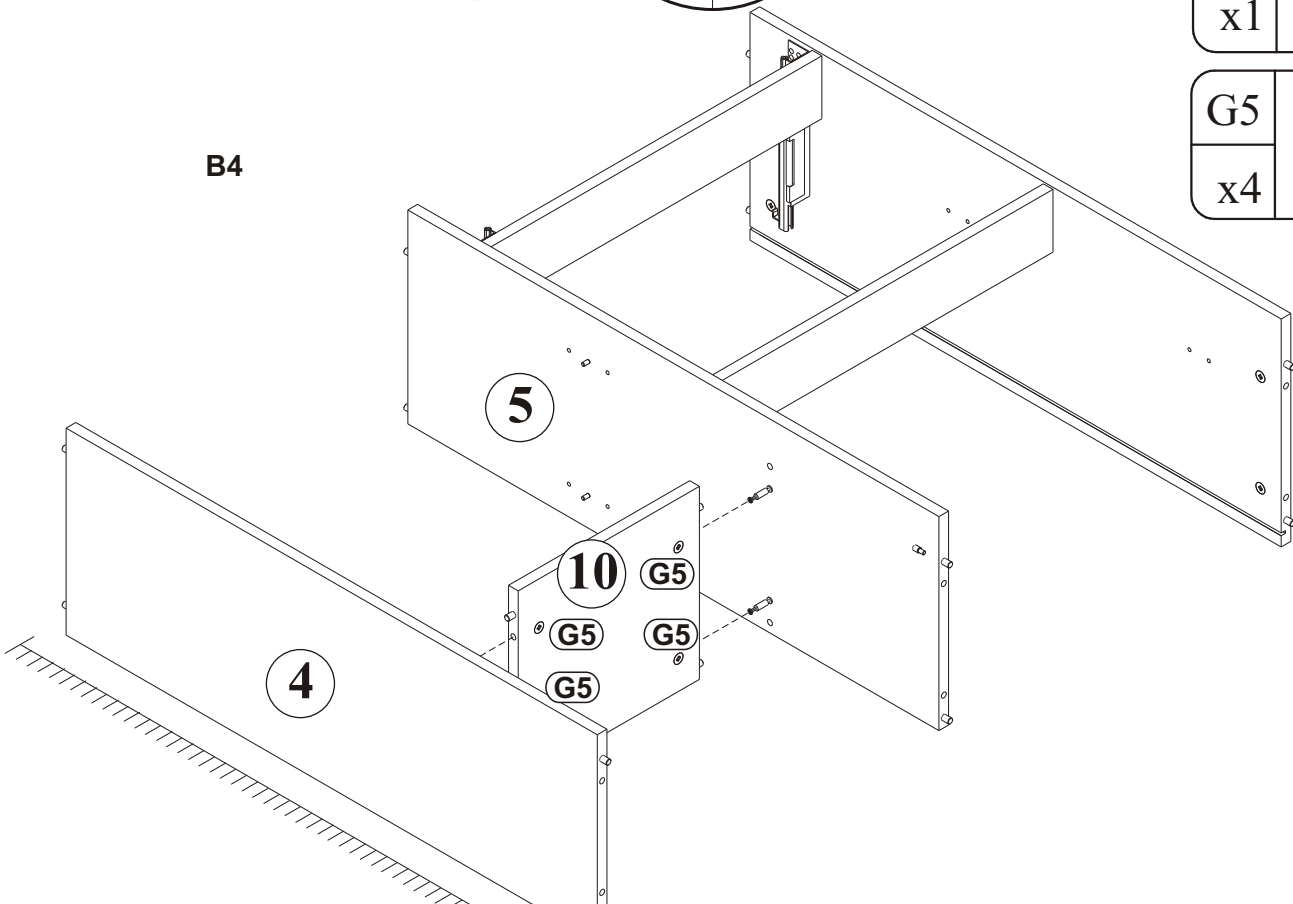

B4

G2	
x1	

G5	
x4	

G2	
x1	

G5	
x6	

21

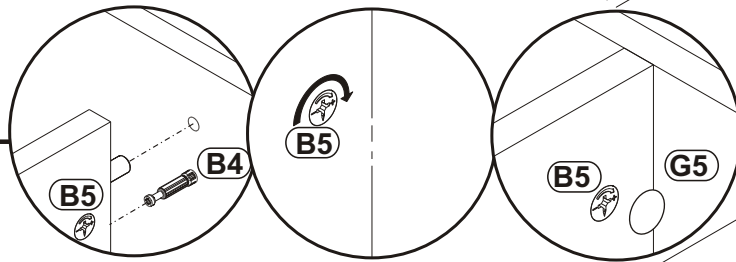
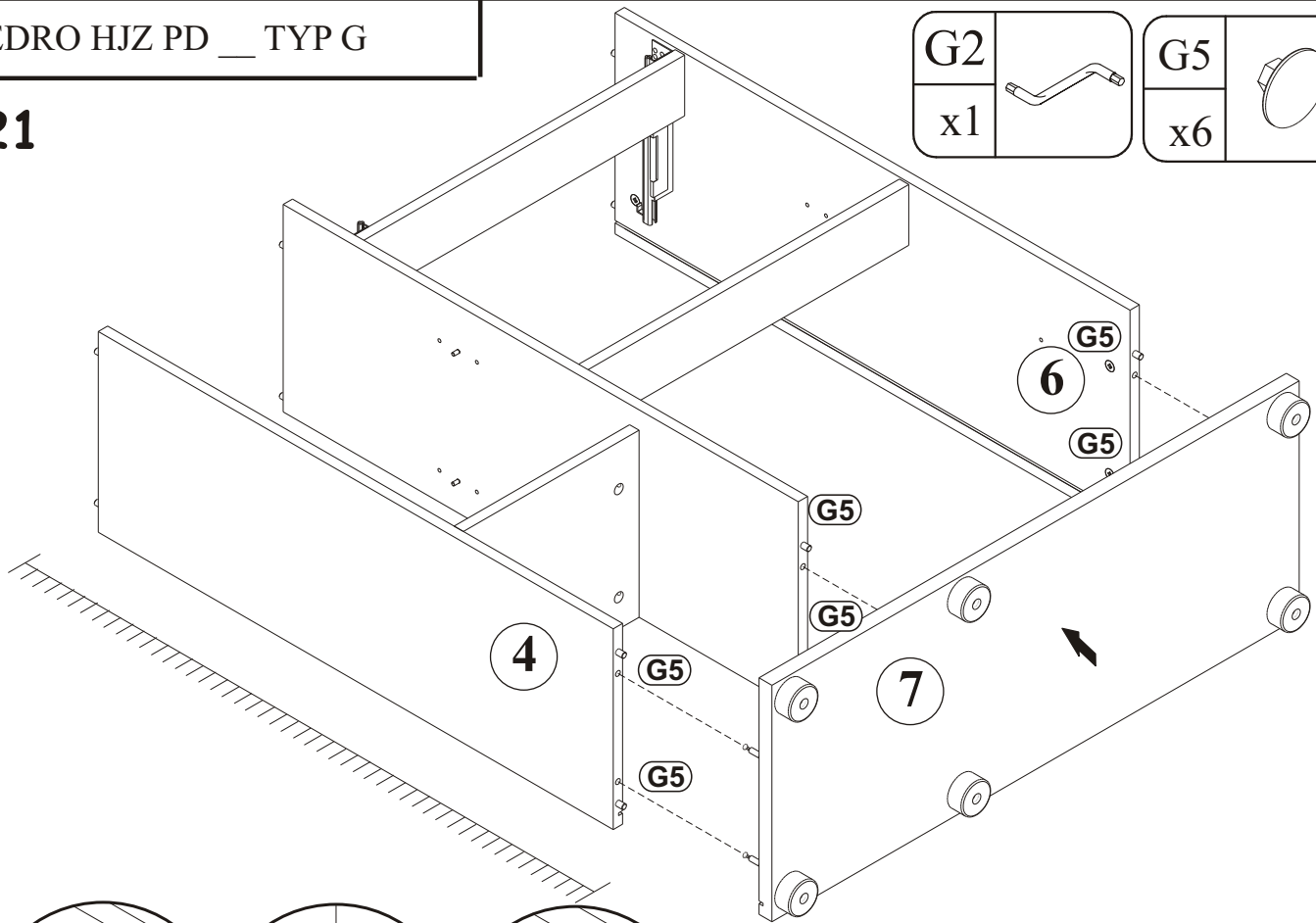

22

G2	
x1	

G5	
x6	

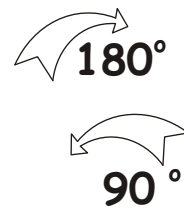
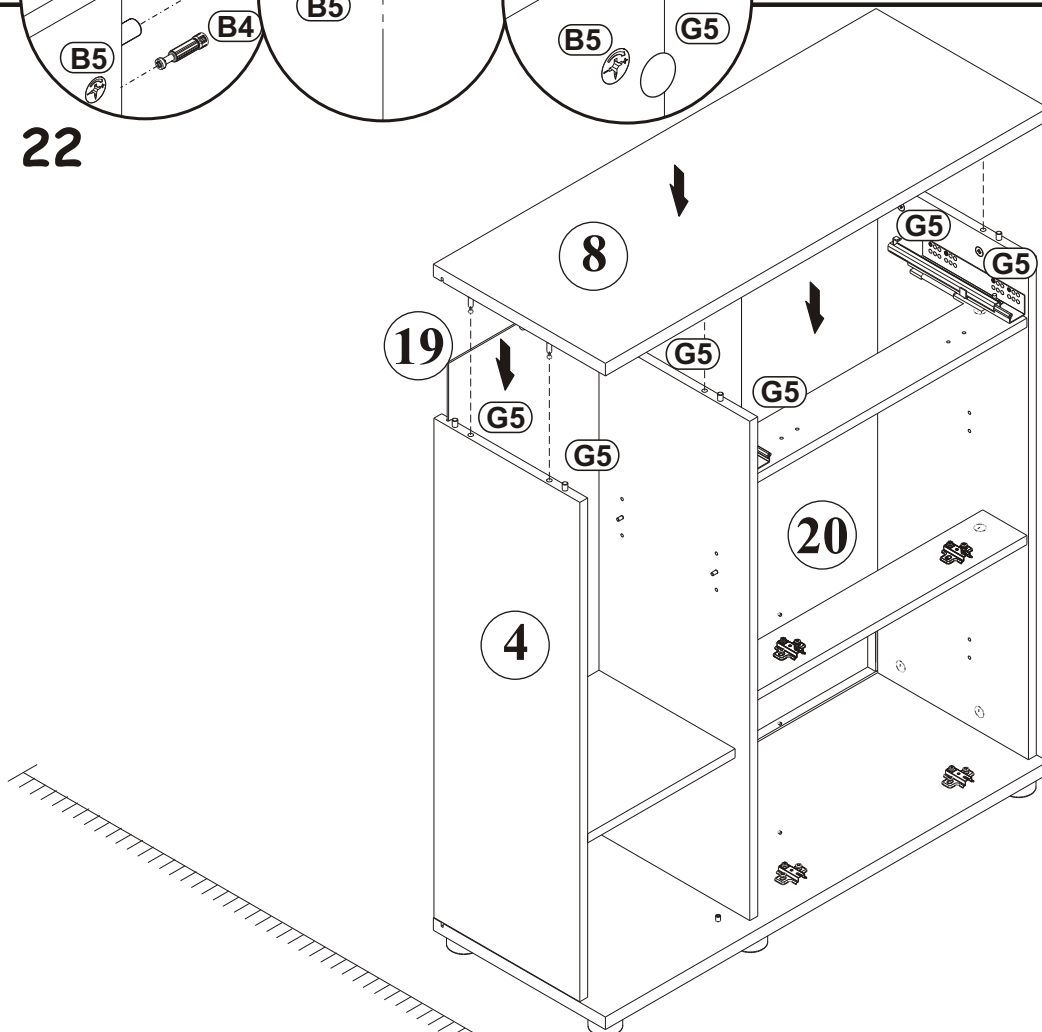

23

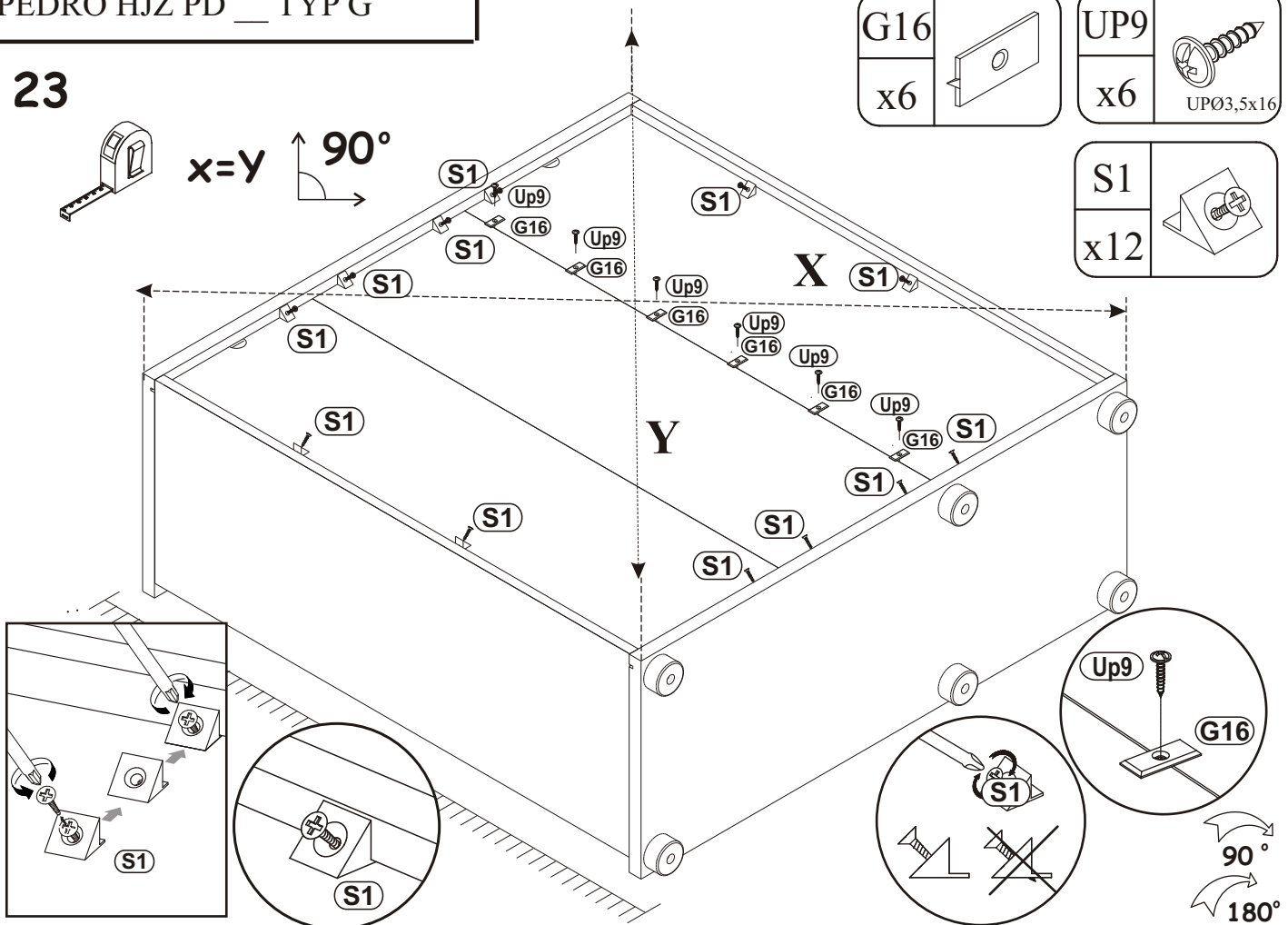

24

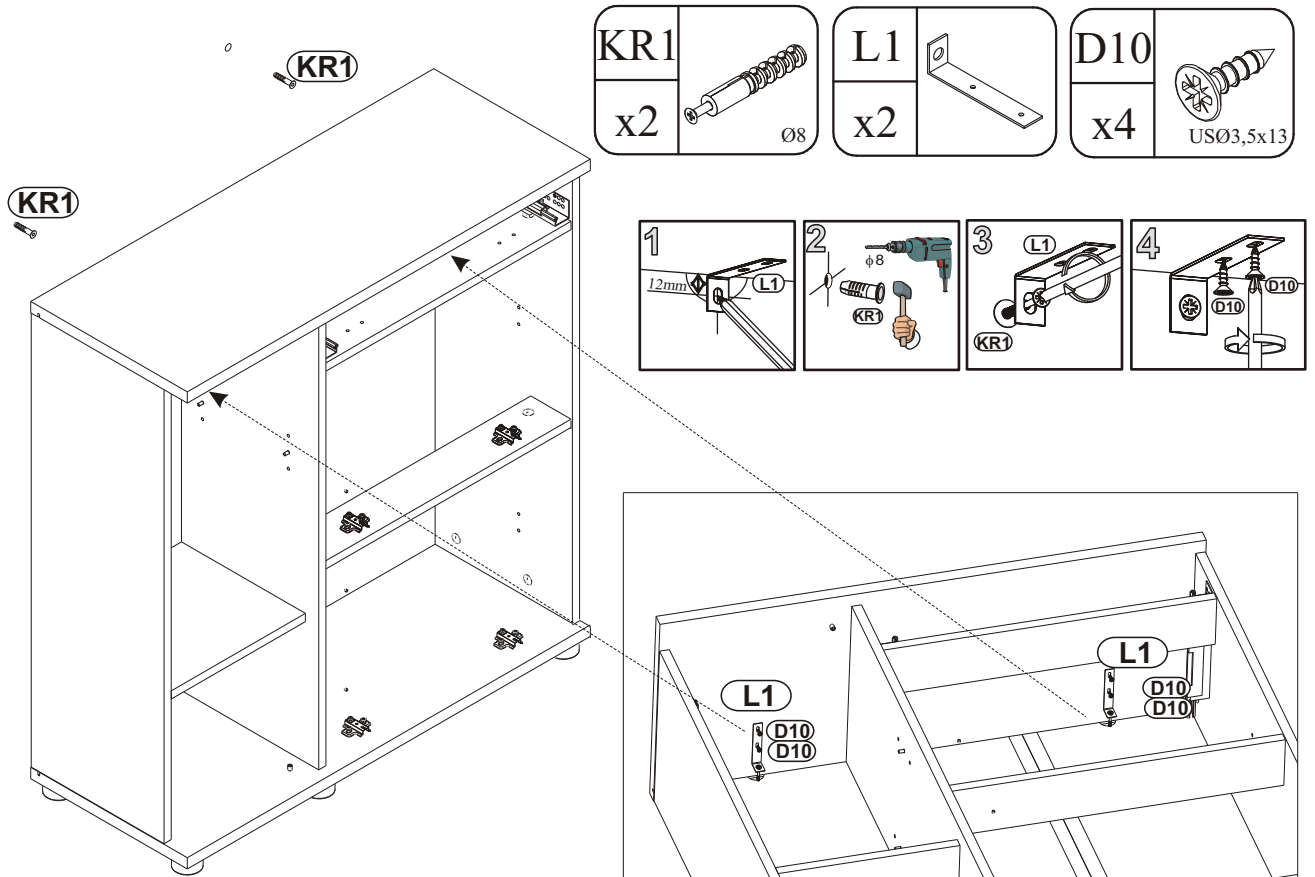

27

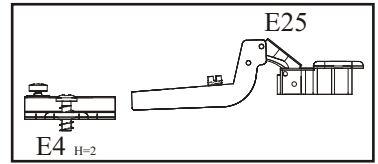
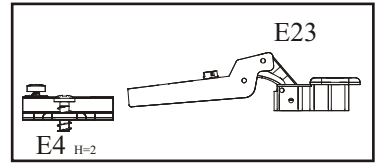
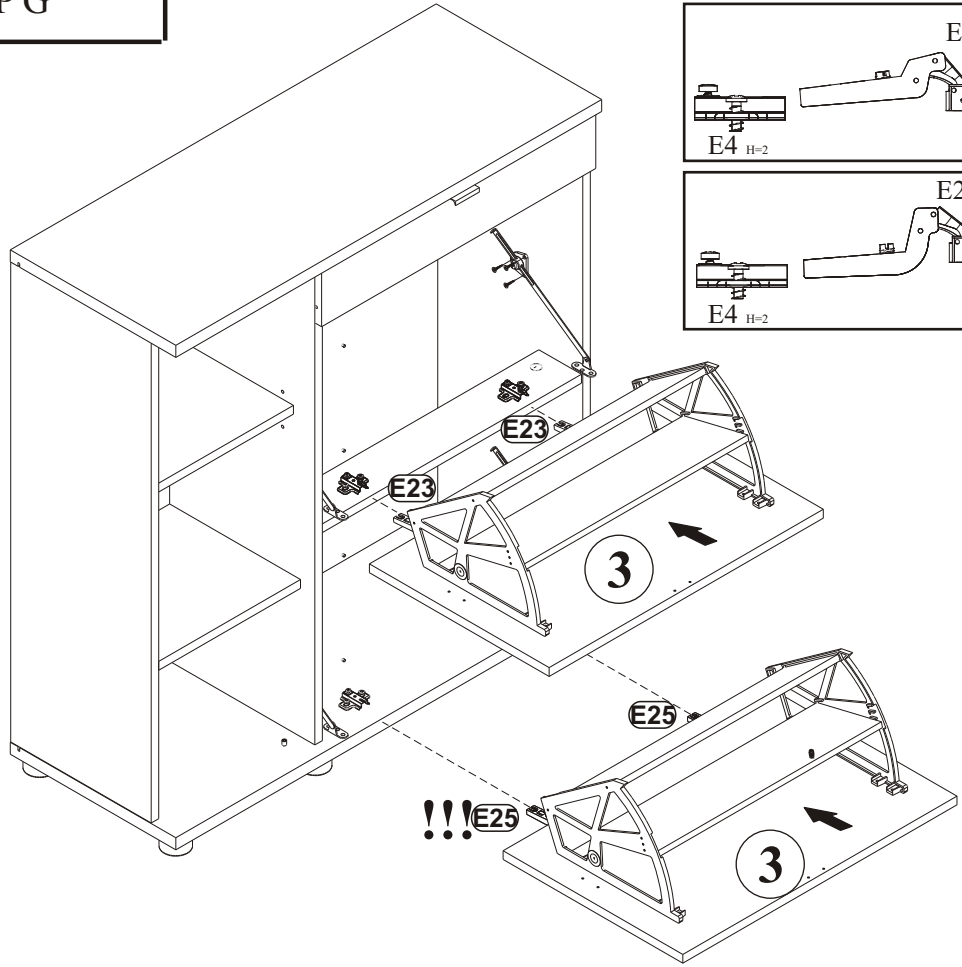
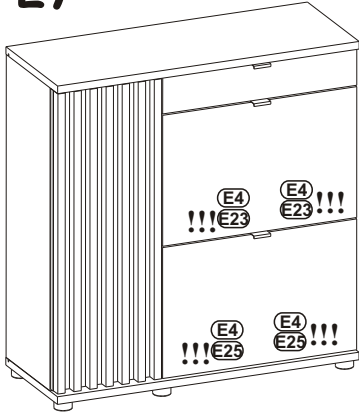

28

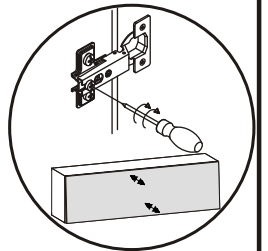
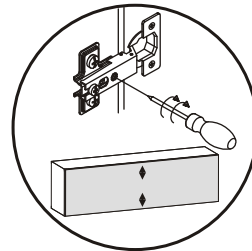
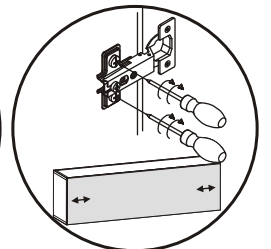
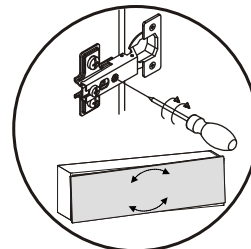
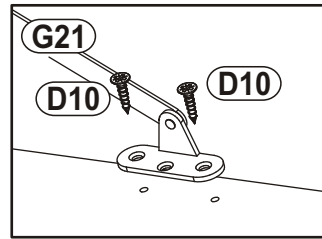
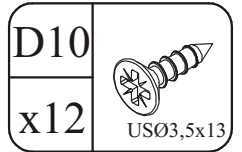
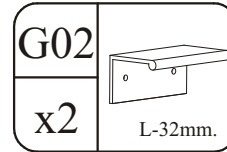
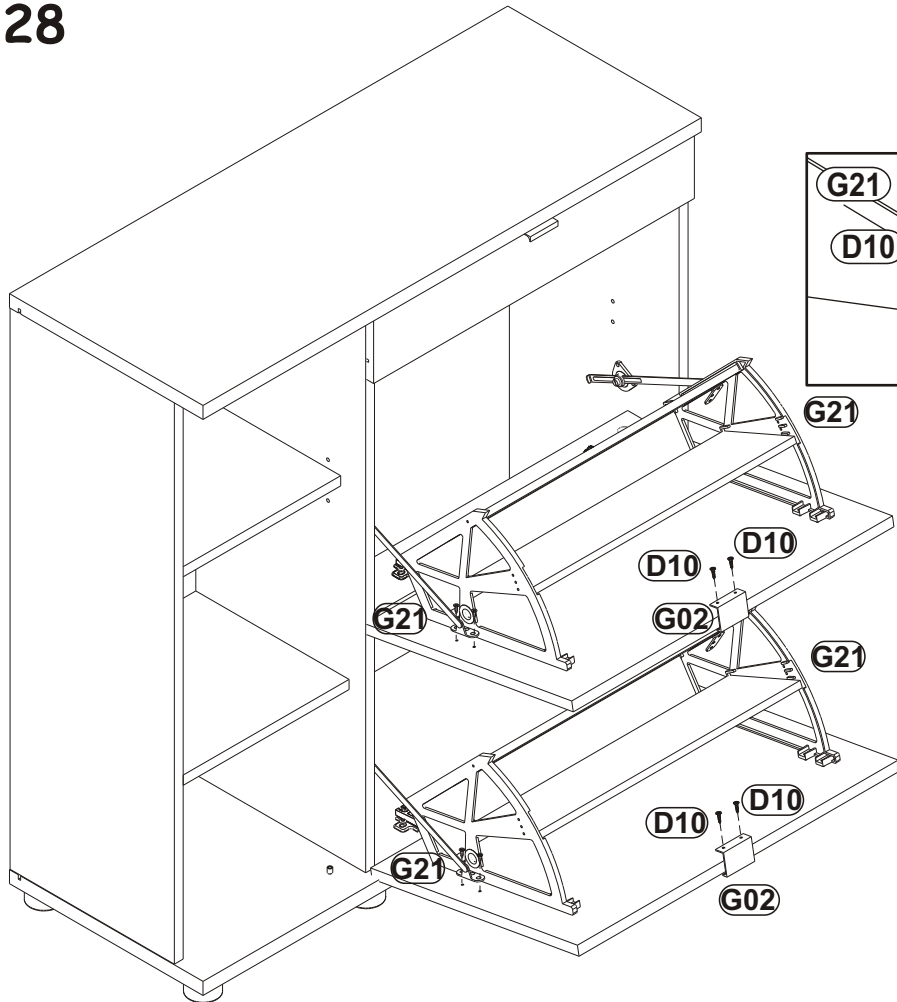

29

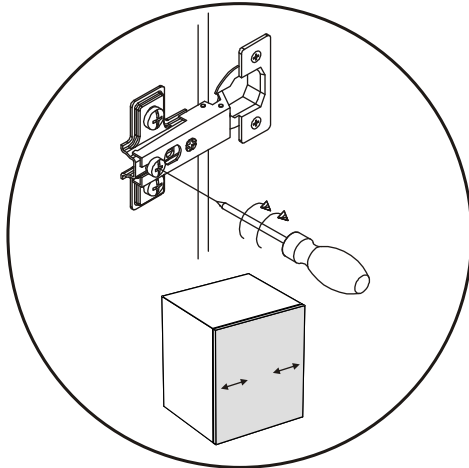
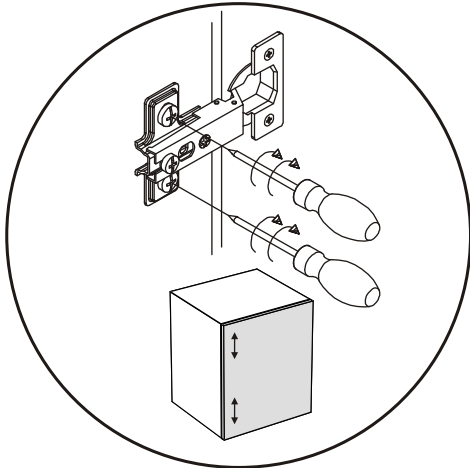
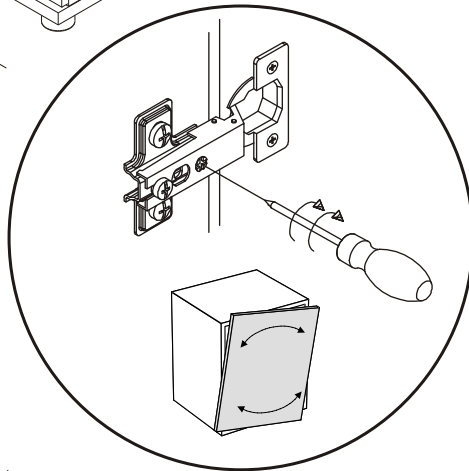
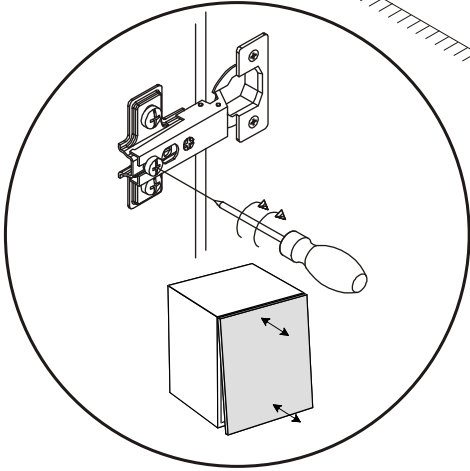
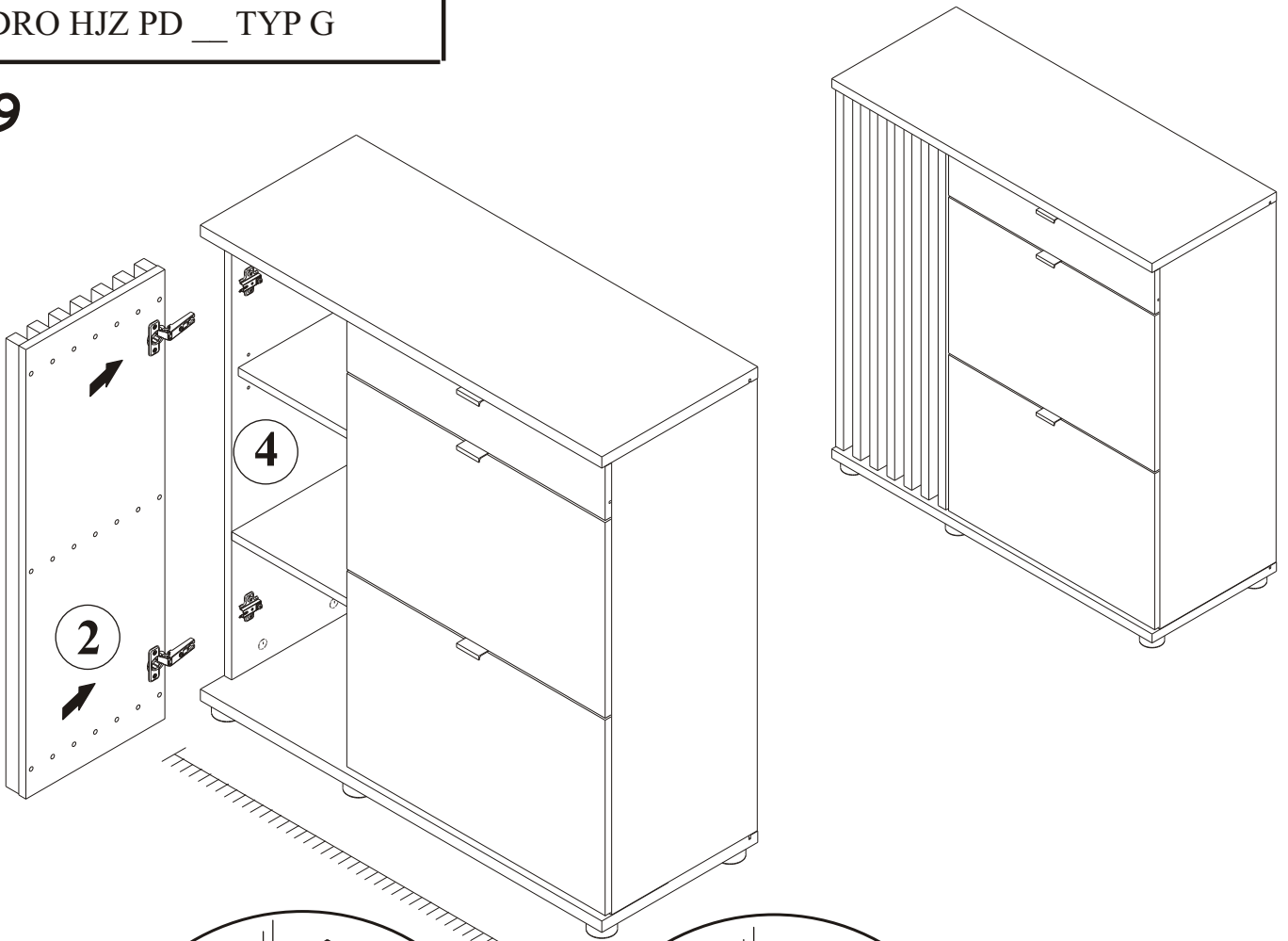

ARMARIO / GUSTAVO / PEDRO TYP H

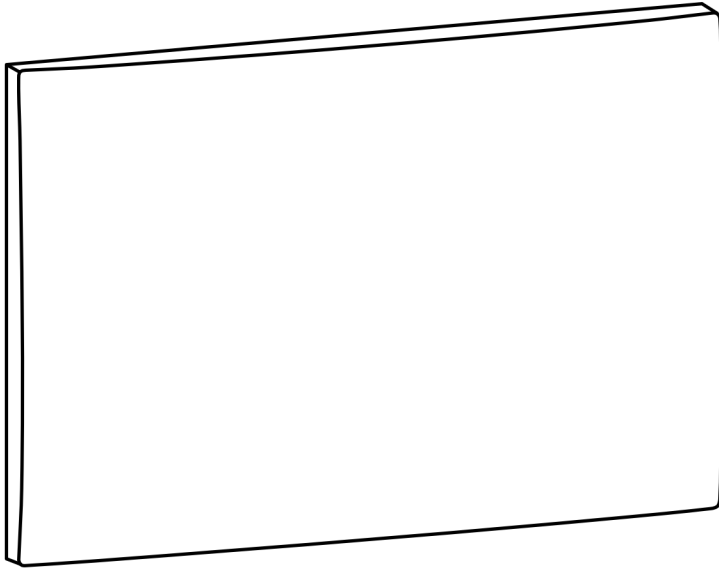

3x

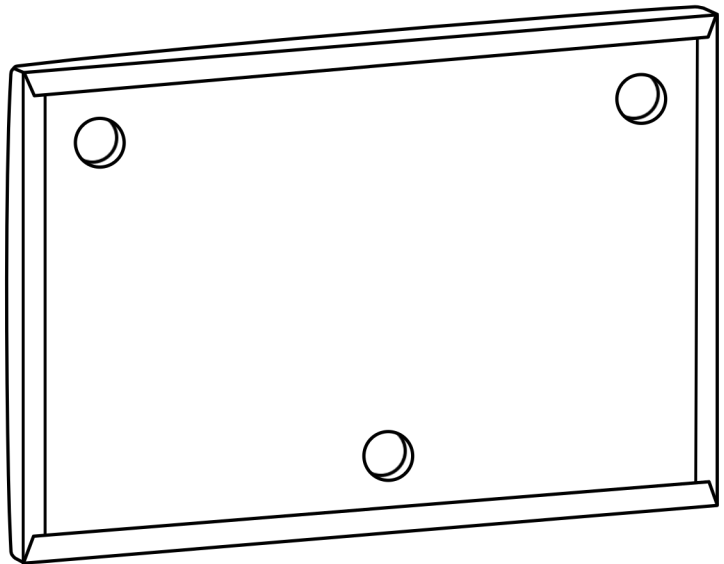

NO	Dim.		Col.-No	Qty
1	600	390	1	3

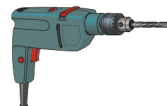

40 min

AR / GV / PD TYP H

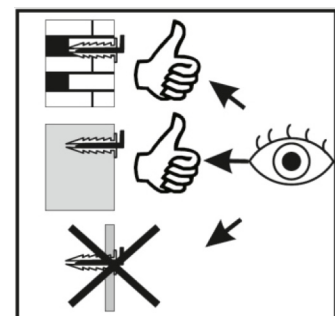
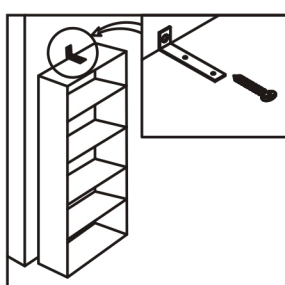
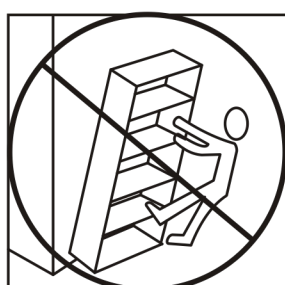
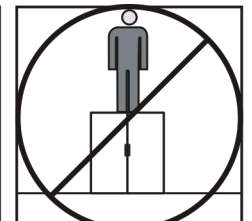
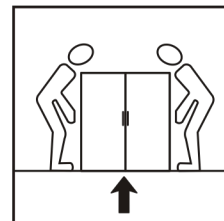
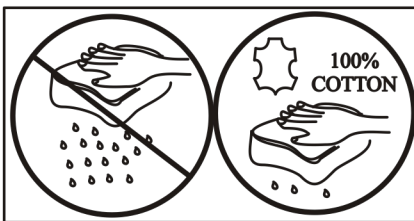
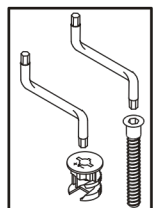
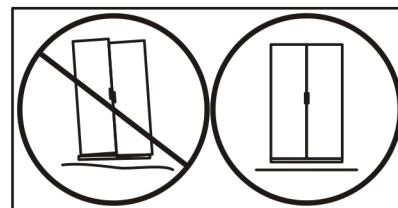
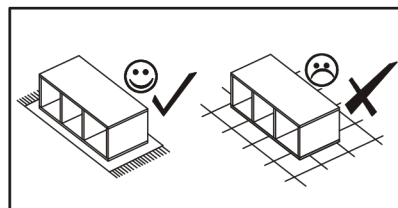
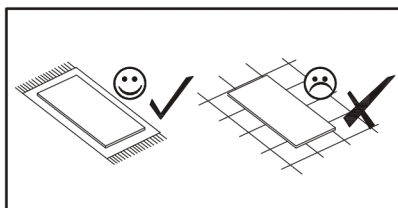
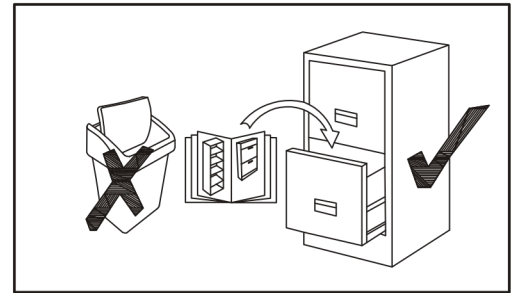
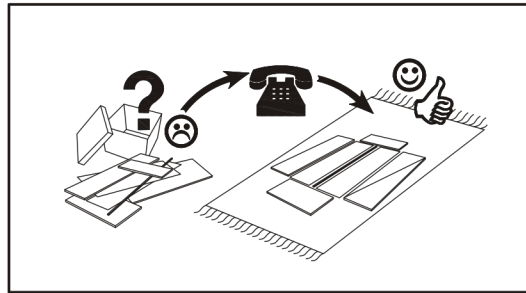
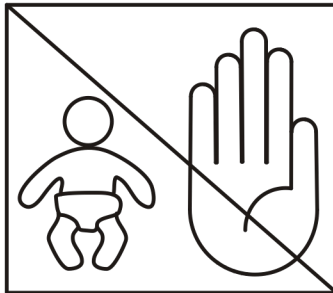
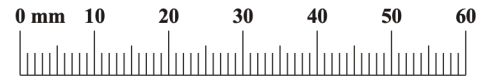
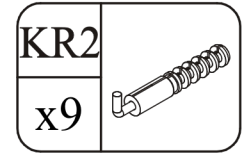
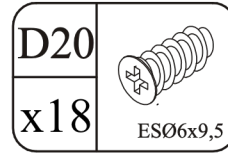
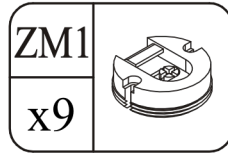

AR / GV / PD TYP H

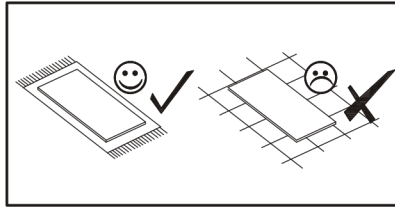

ZM1		D20	
x3		x6	ESØ6x9,5

3x

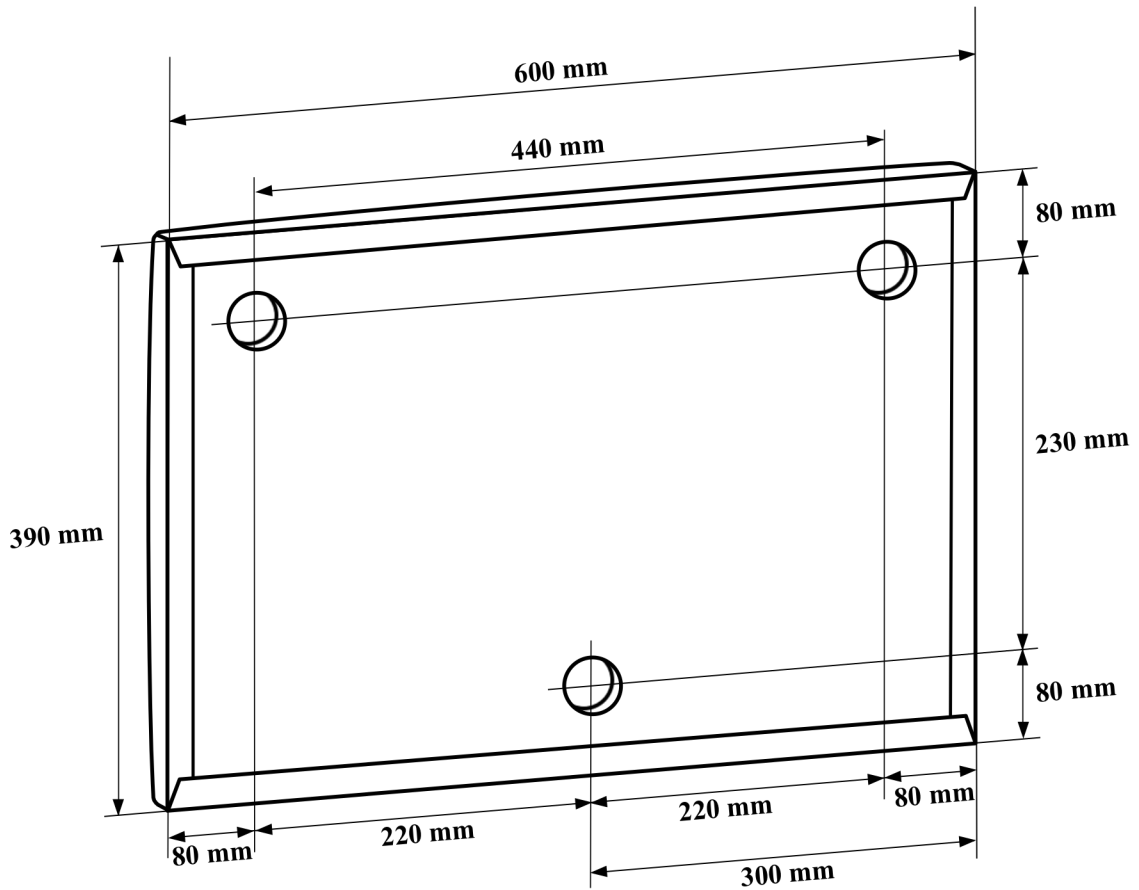
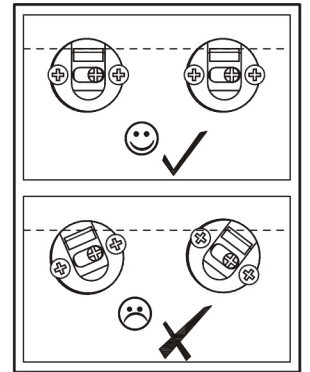
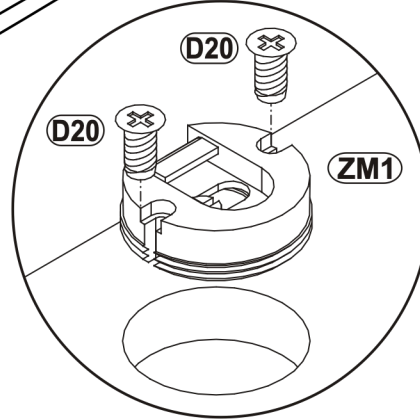
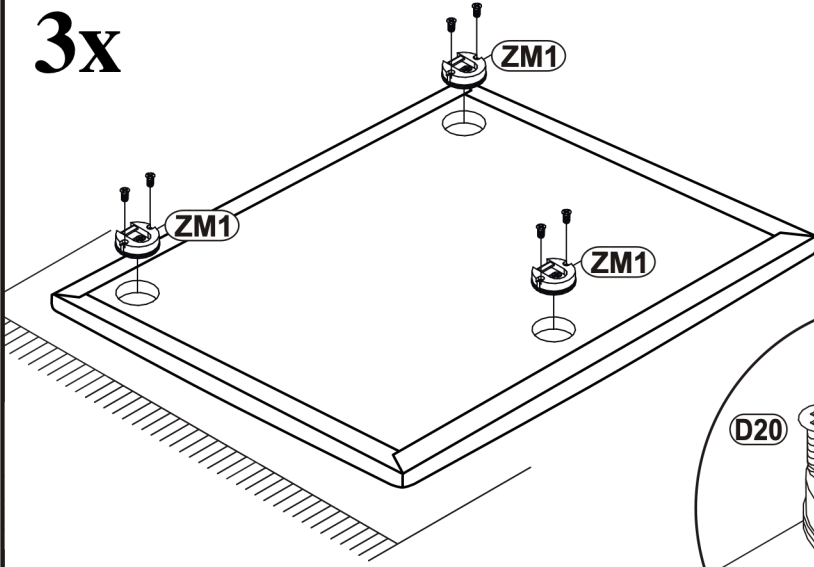

AR / GV / PD TYP H

KR2
x9

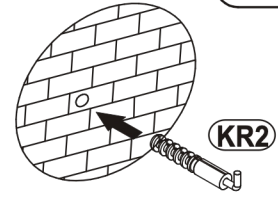
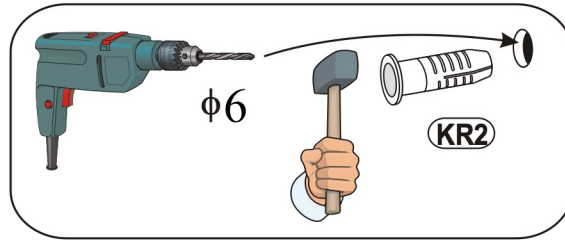
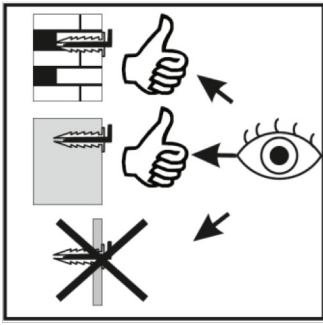
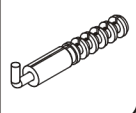

3x

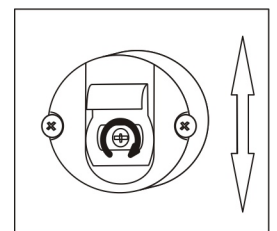
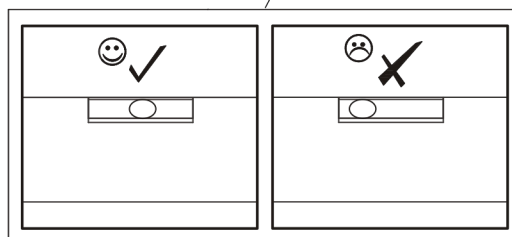
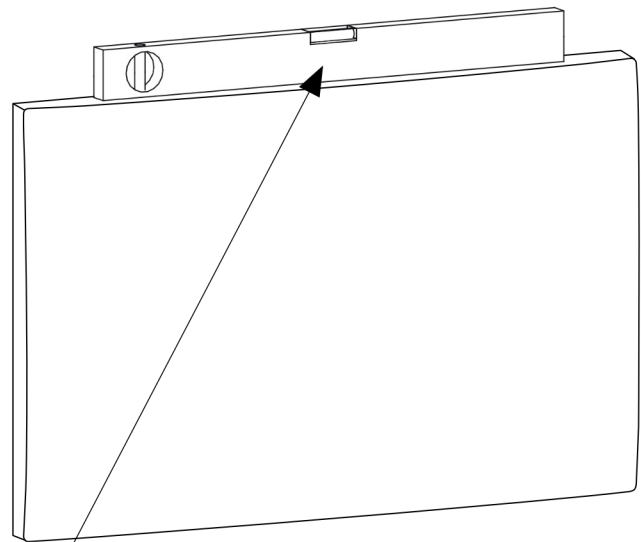
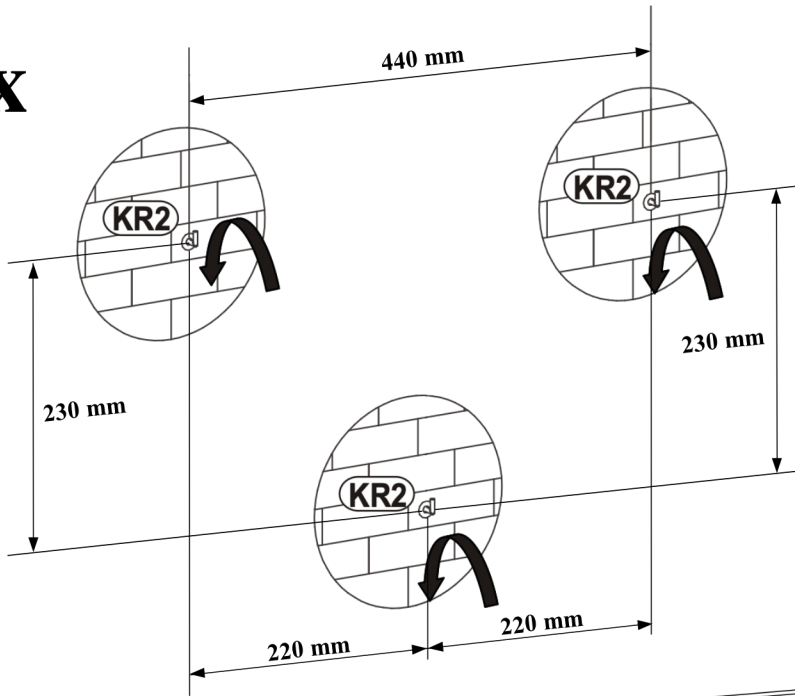

PEDRO HJZ PD ___ TYP H

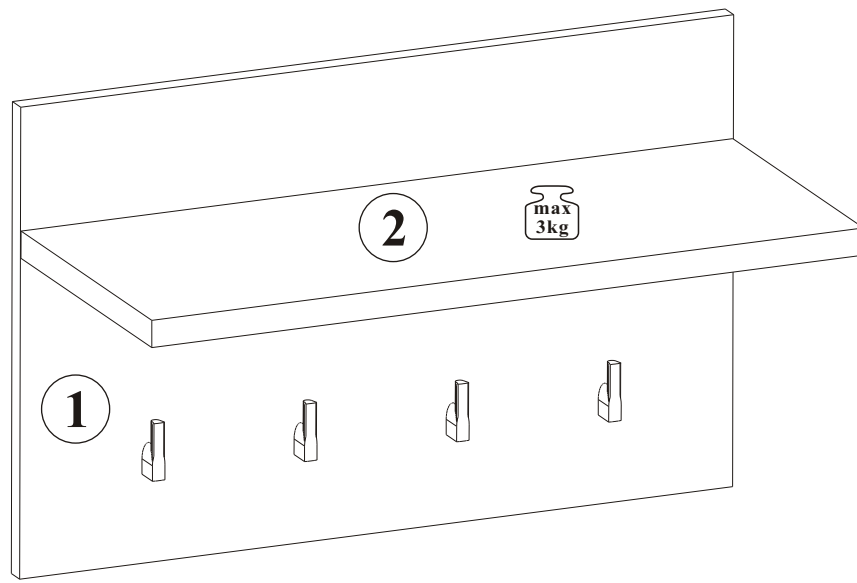
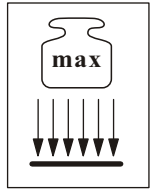

NO	DIM [mm]		COL.-NO	QTY
1	600	381	16	1/1
2	599	250	22	1/1

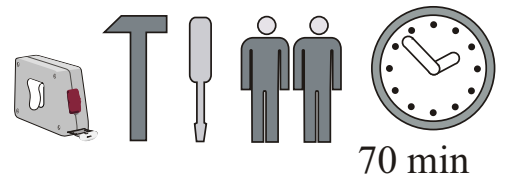

70 min

PEDRO HJZ PD _ TYP H

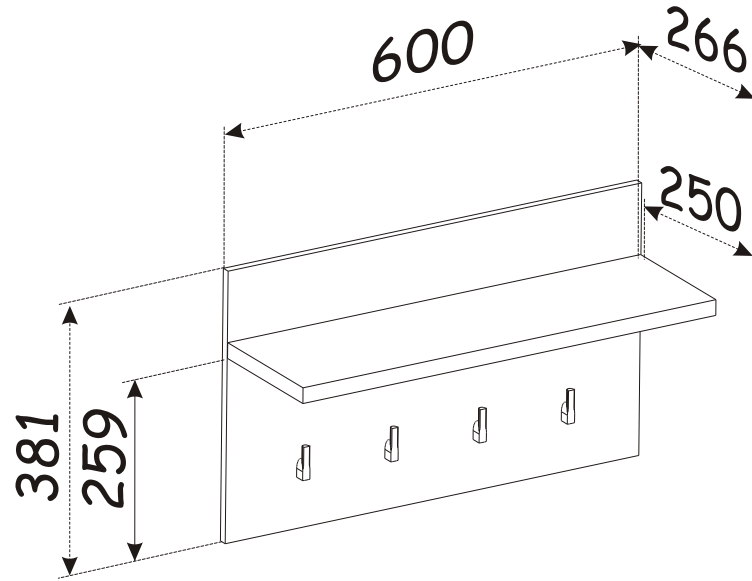

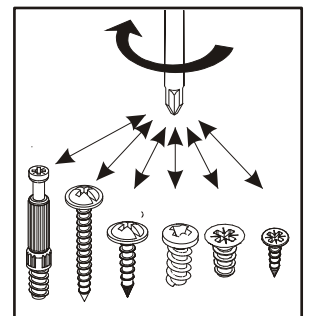
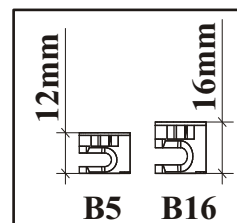
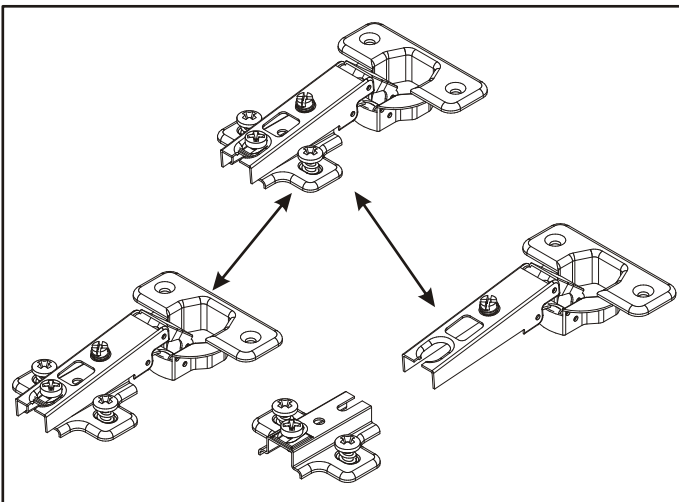
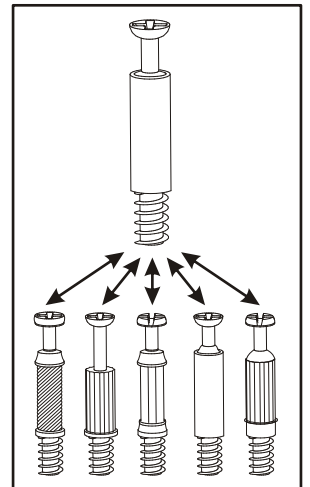
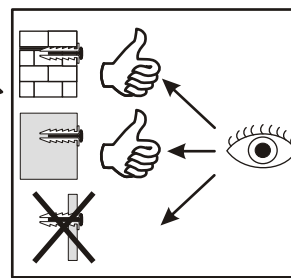
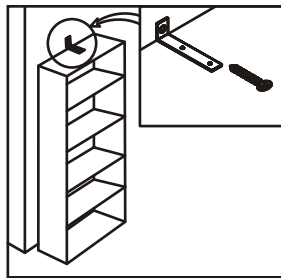
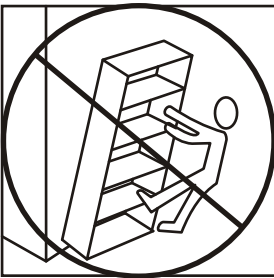
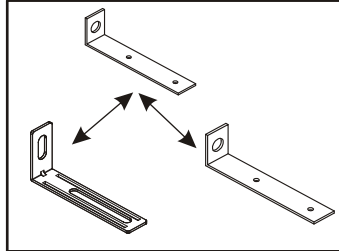
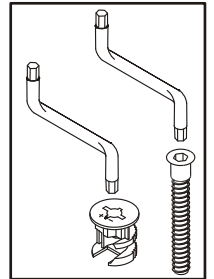
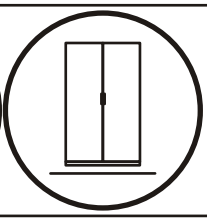
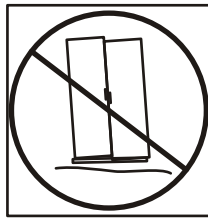
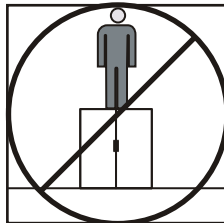
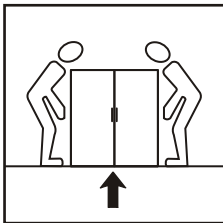
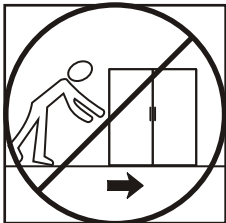
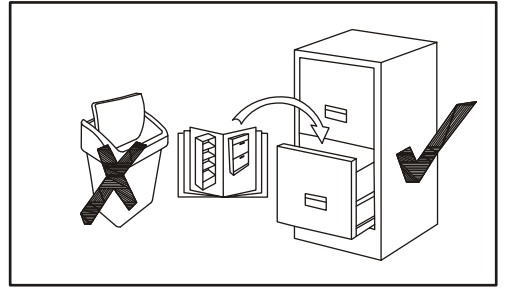
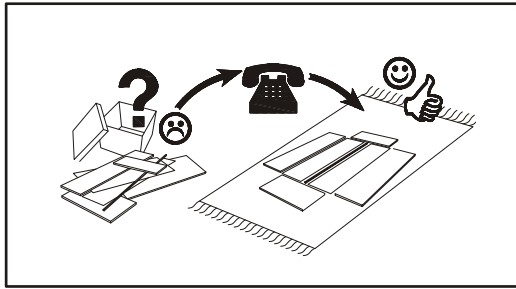
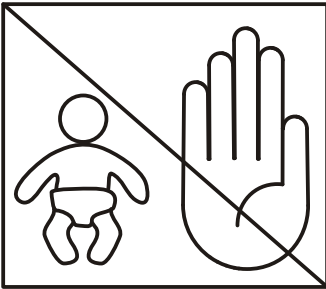
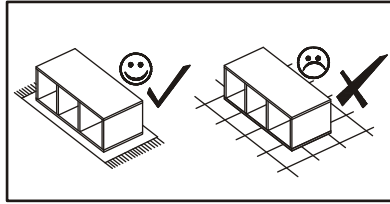
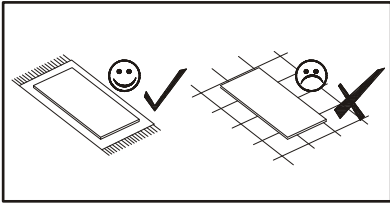

PEDRO HJZ PD _ TYP H

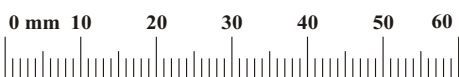
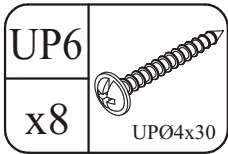
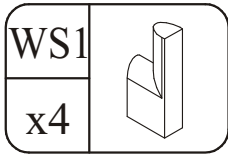
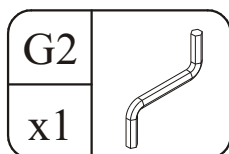
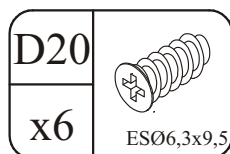
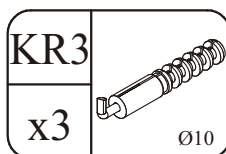
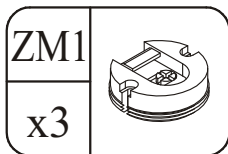
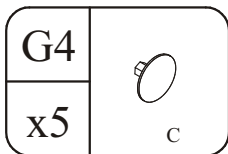
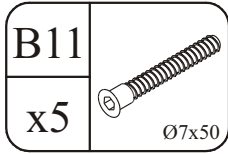

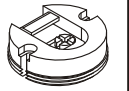
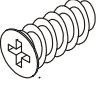

1

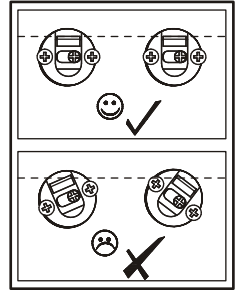
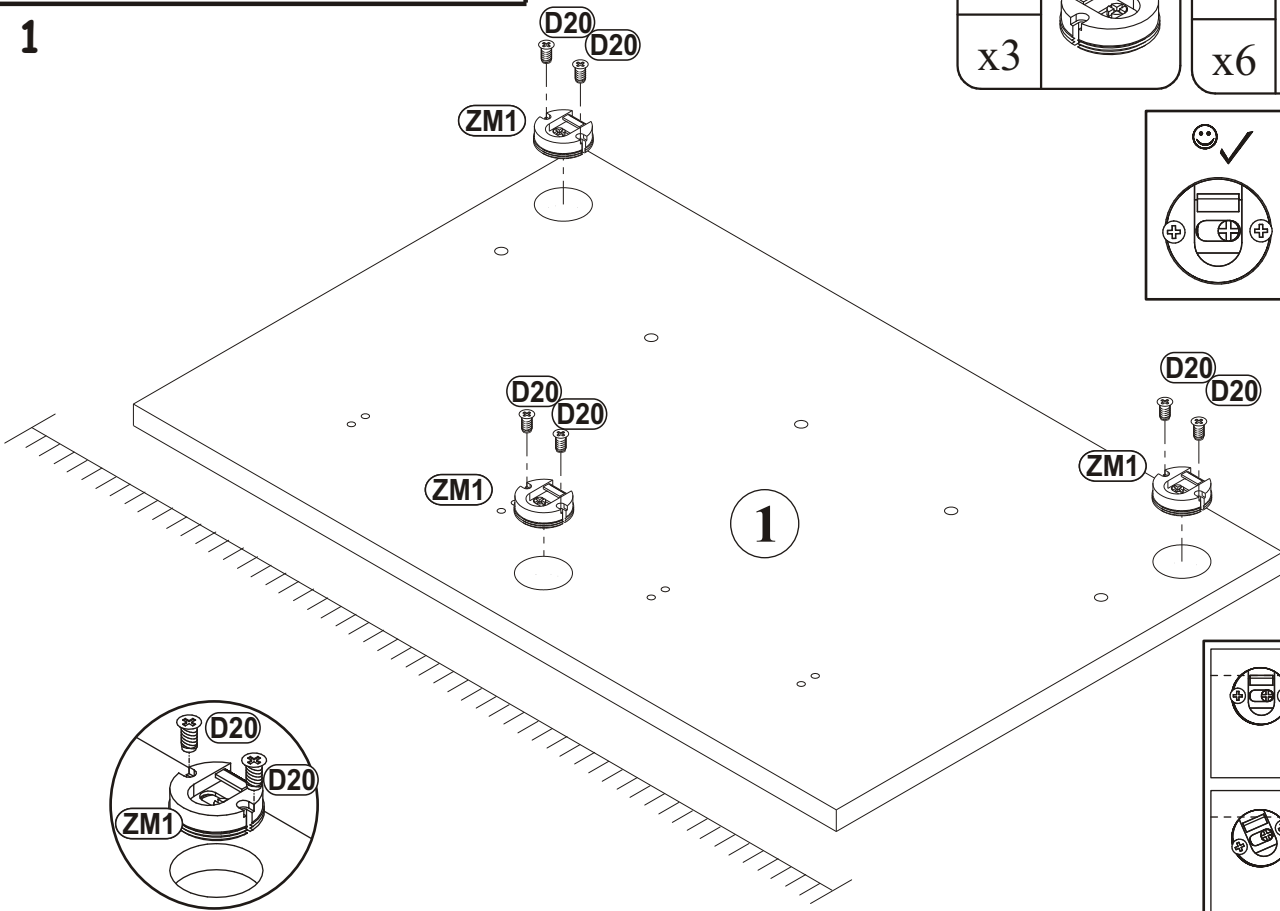
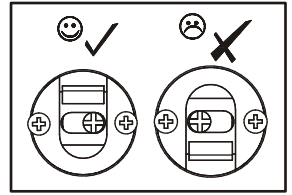
ZM1		D20	
x3		x6	ESØ6,3x9,5



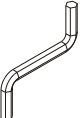

2

B11		G4	
x5	Ø7x50	x5	C

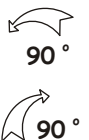
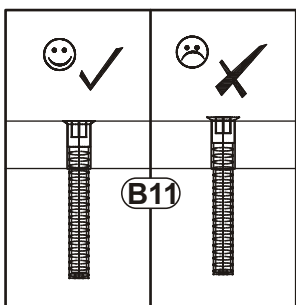
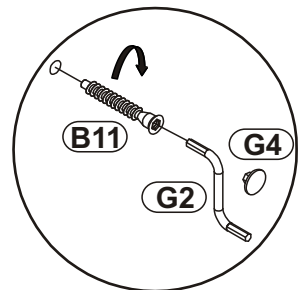
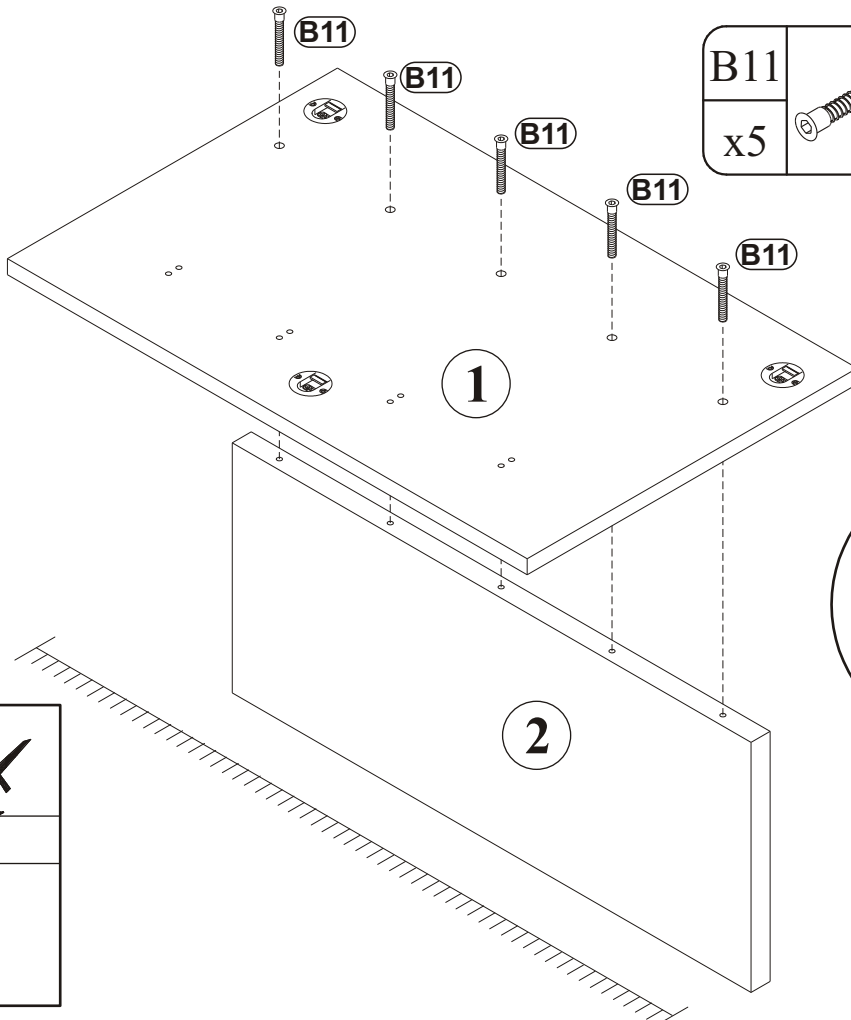
G2	
x1	

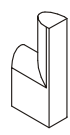

3

WS1		UP6	
x4		x8	UPØ4x30

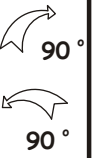
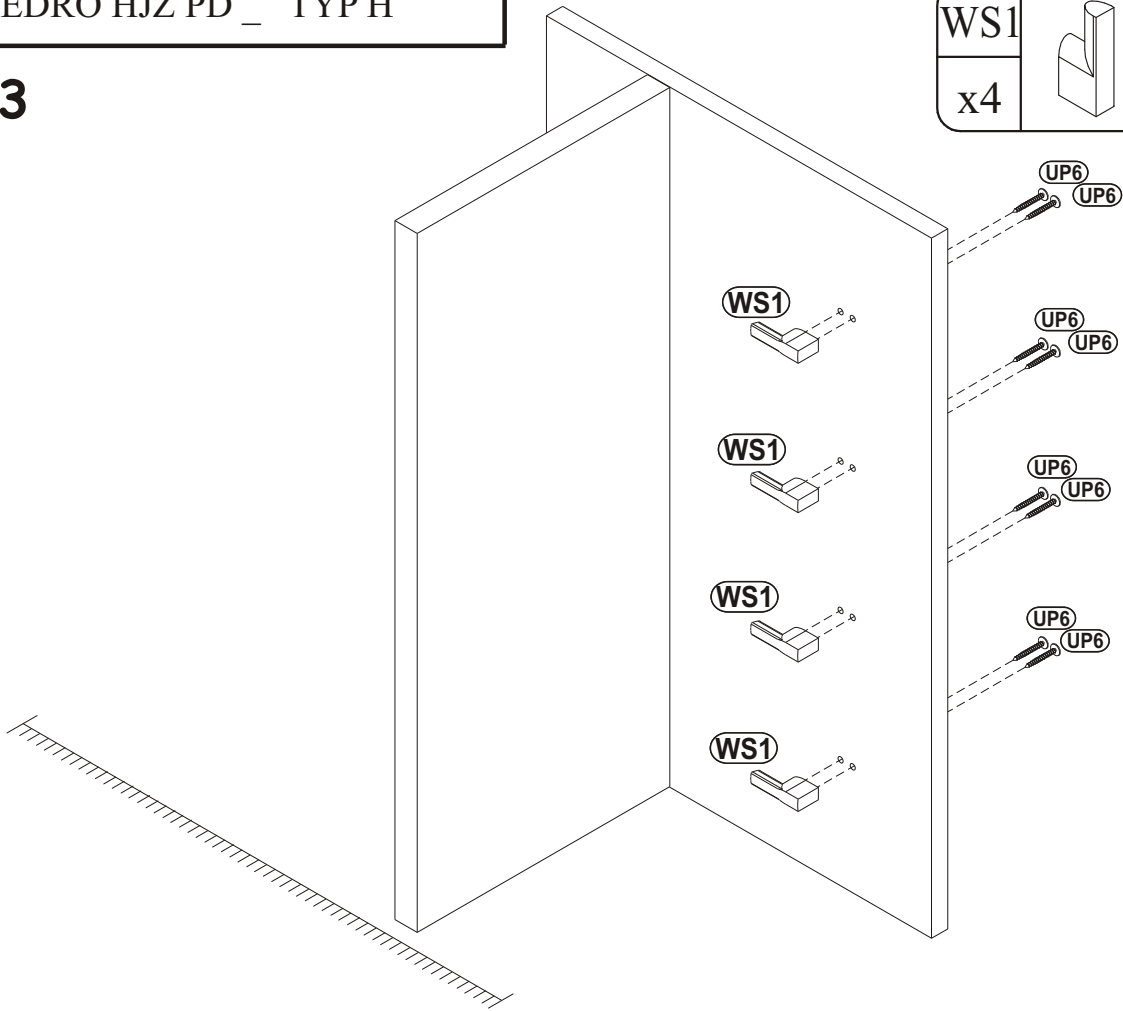

4

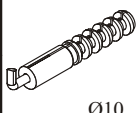
KR3	
x3	Ø10

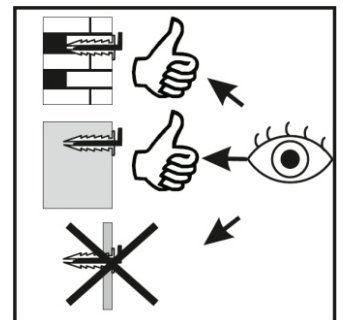
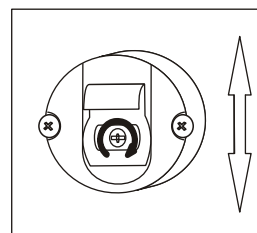
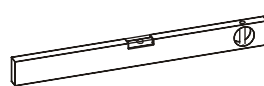
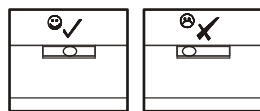
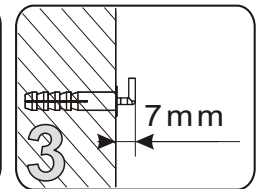
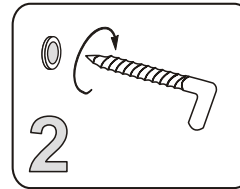
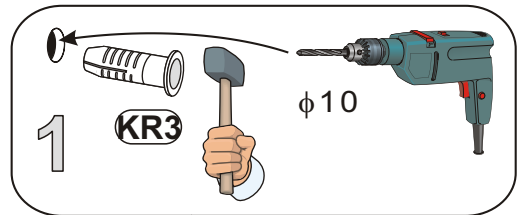
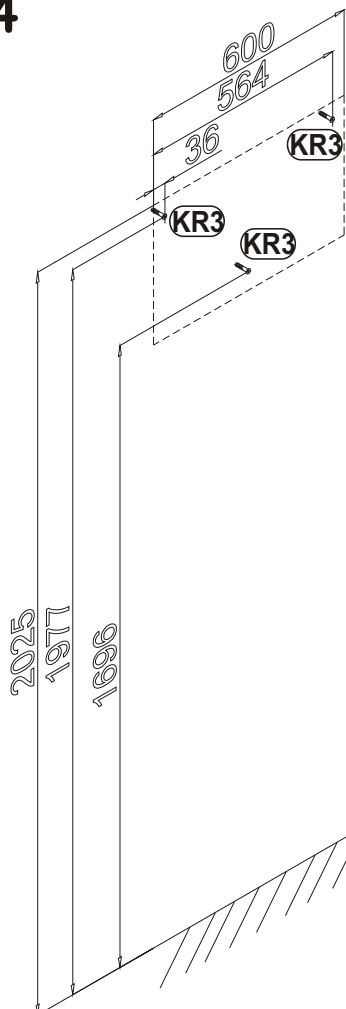

PEDRO HJZ PD ___ TYP F

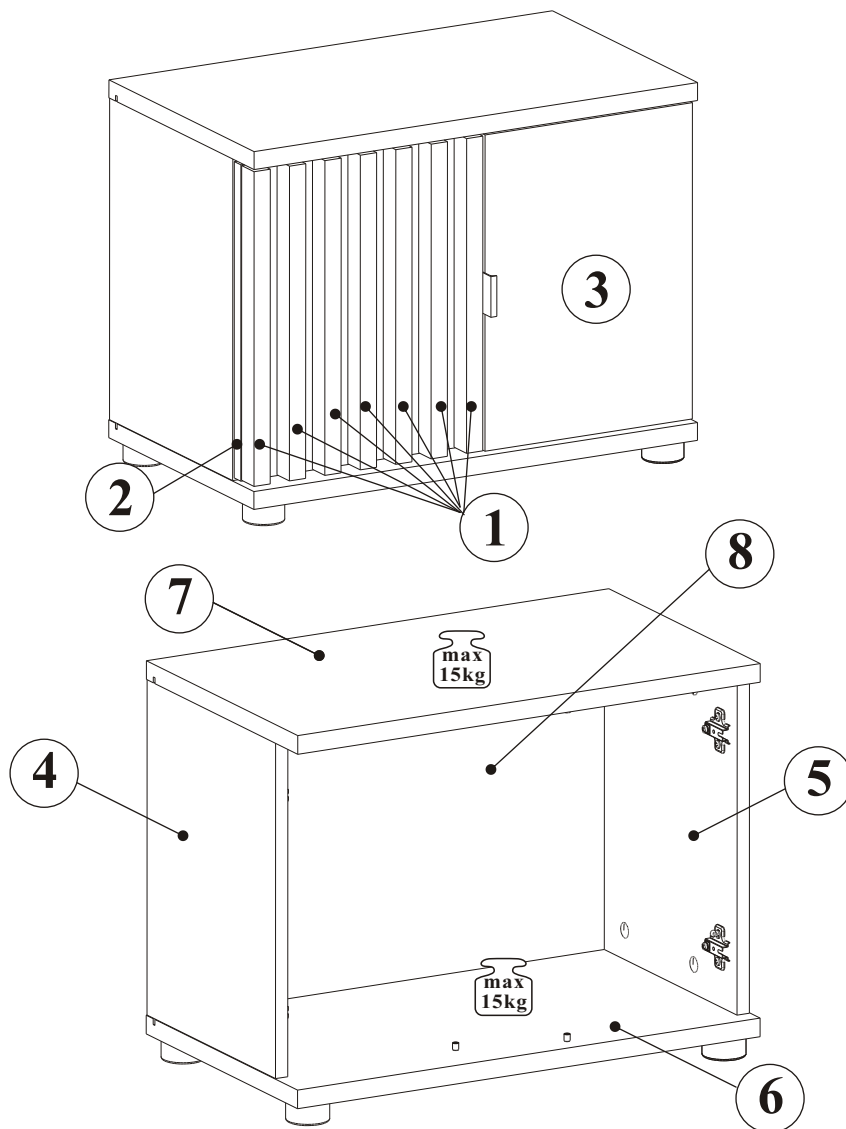
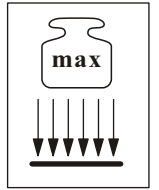

NO	DIM [mm]		COL.-NO	QTY
1	387	30	22 1/1	7
2	312	389	16 1/1	1
3	281	389	16 1/1	1
4	396	297	16 1/1	1
5	396	327	16 1/1	1
6	601	350	22 1/1	1
7	601	350	22 1/1	1
8	408	579	3 1/1	1

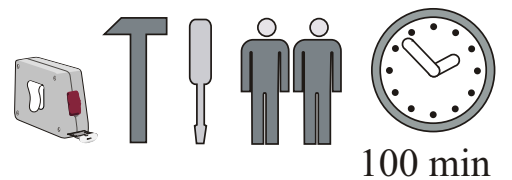



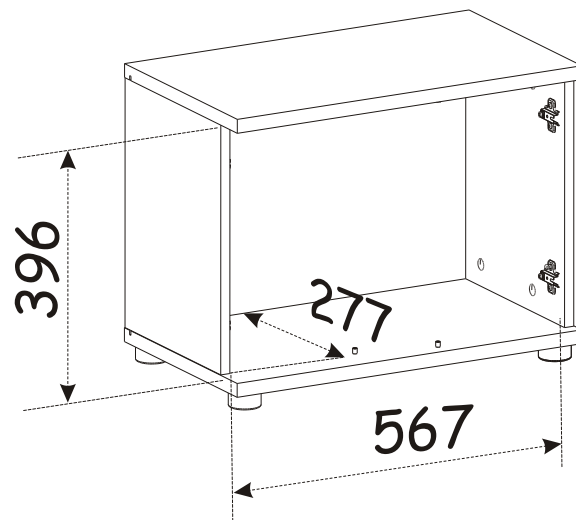
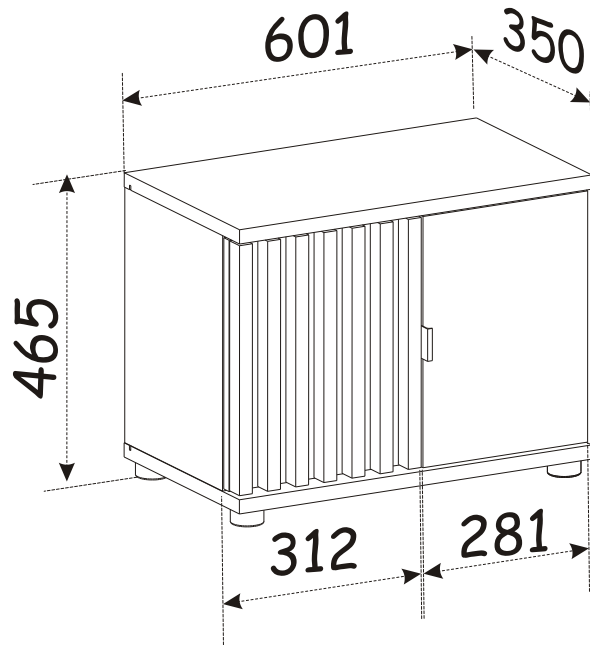

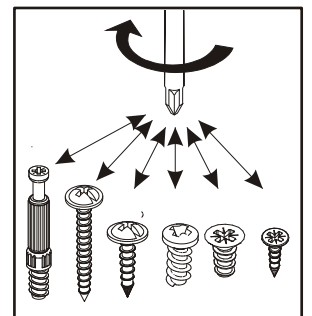
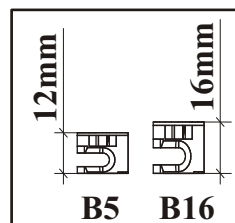
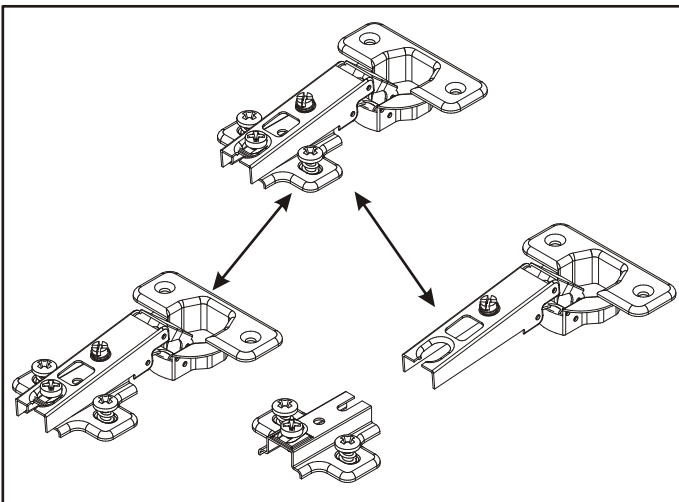
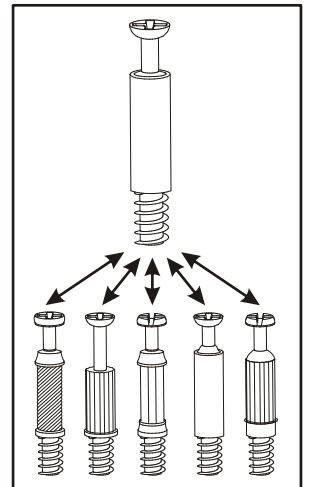
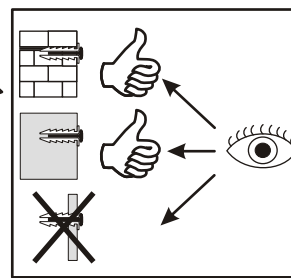
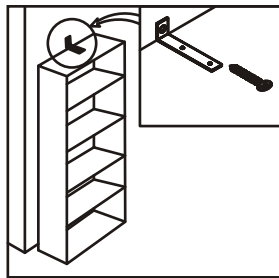
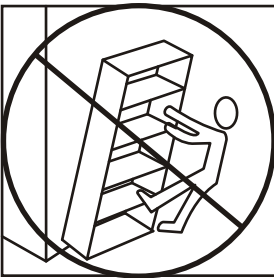
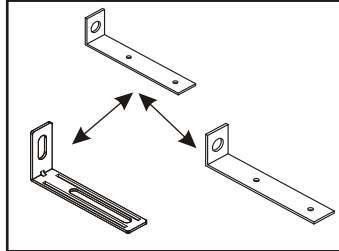
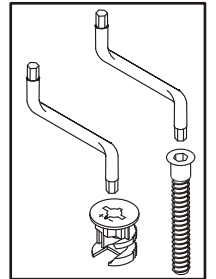
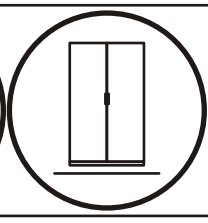
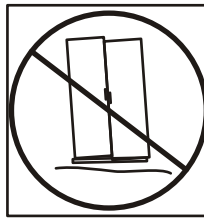
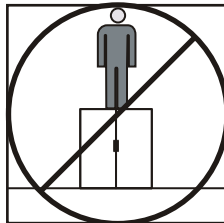
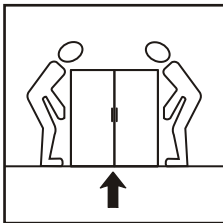
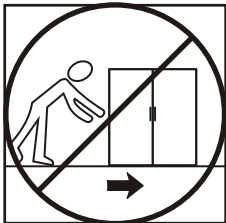
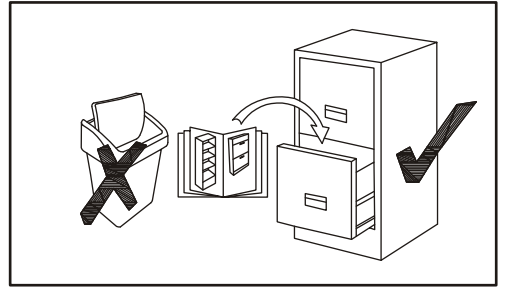
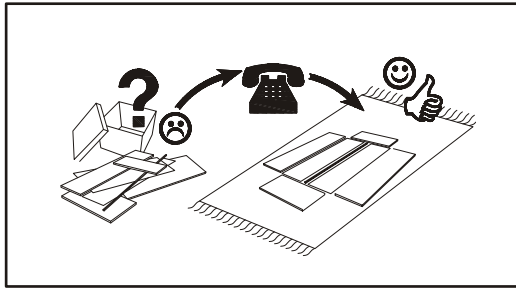
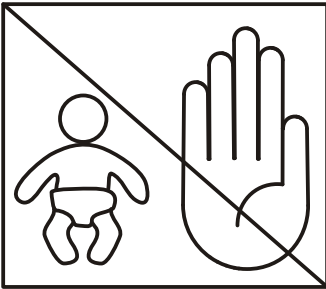
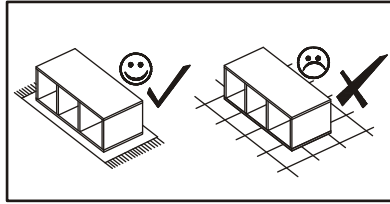
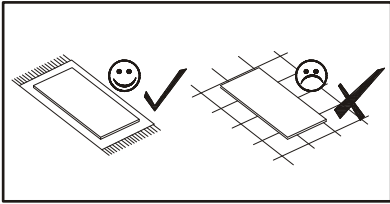

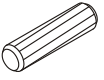

PEDRO HJZ PD _ TYP F

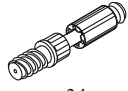

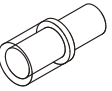
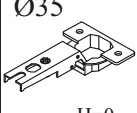
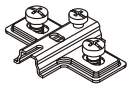
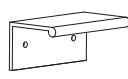
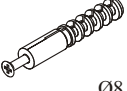
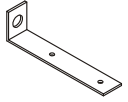
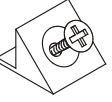
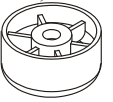

PEDRO HJZ PD _ TYP F

A1 x8  ø8x36	B22 x21  Ø7x40	G4 x18 	B4 x8  34	B5 x8  ø15x12	G5 x8 
G20 x4 	E21 x4  Ø35 H=0	E2 x4  H=0	G02 x1  L-32mm.	KR1 x2  Ø8	L1 x2 
S1 x6 	ST7 x4  Ø50, h=25	UP17 x4  UPØ4x25	D10 x14  USØ3,5x13	G2 x1 	G12 x3  Ø14

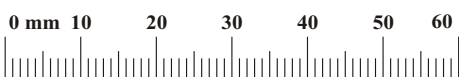

1

G12	
x3	Ø14

B22	
x21	Ø7x40

G4	
x18	

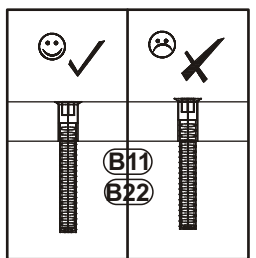
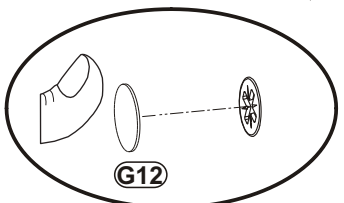
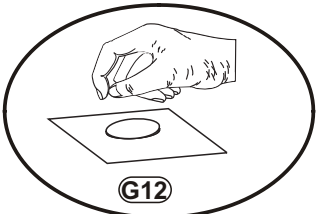
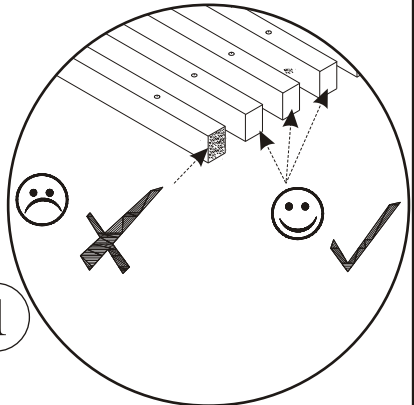
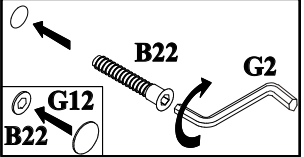
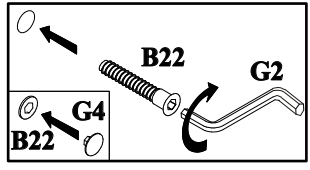
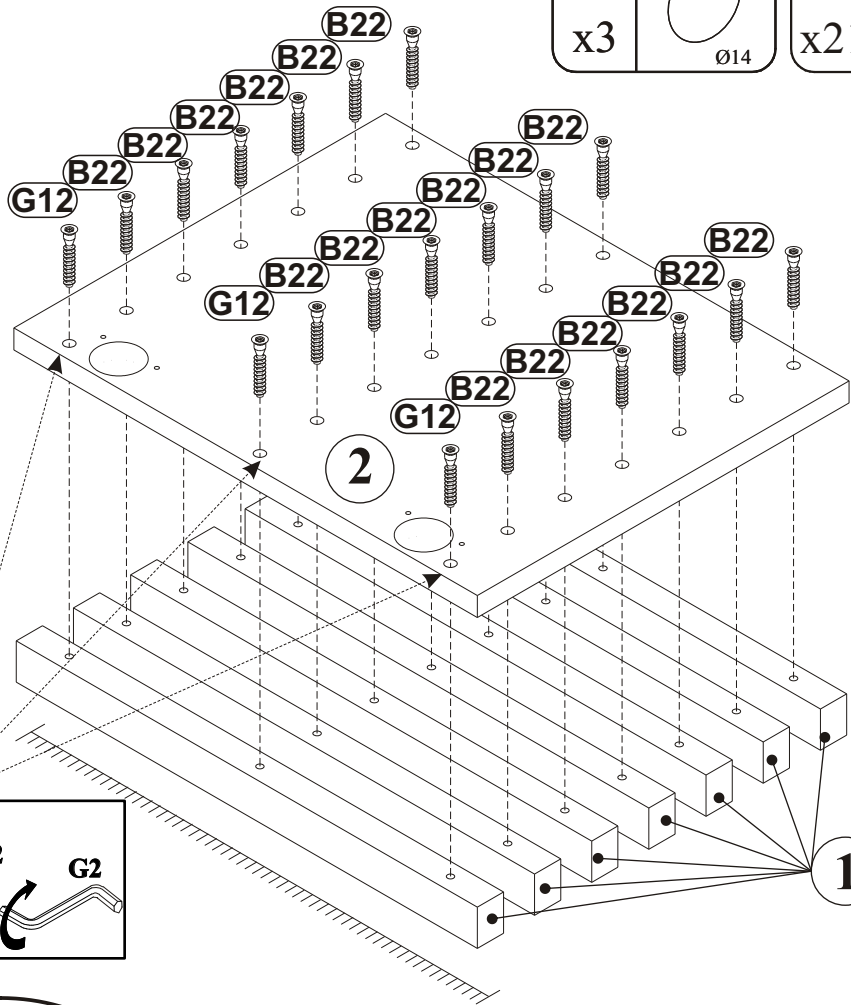

2

D10	
x4	USØ3,5x13

E21	Ø35
x2	H=0

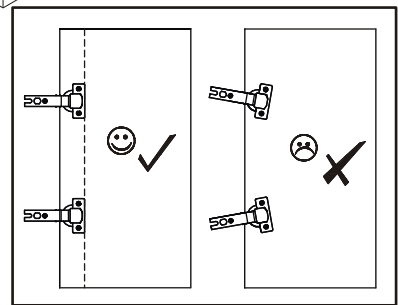
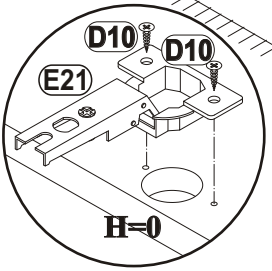
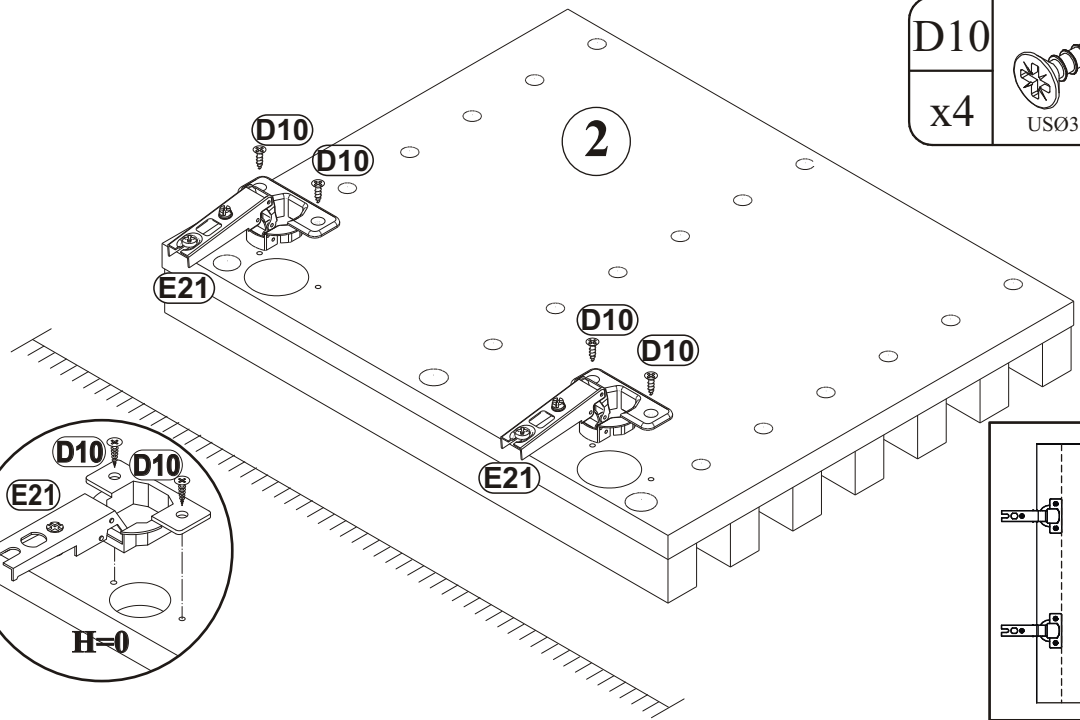

3

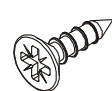
D10	
x6	USØ3,5x13

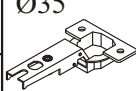
E21	Ø35 
x2	H=0

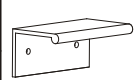
G02	
x1	L-32mm.

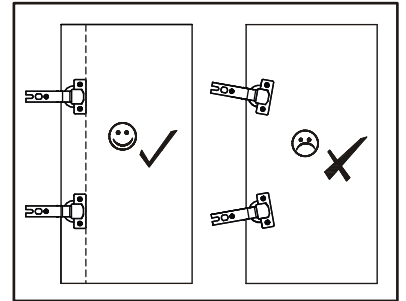
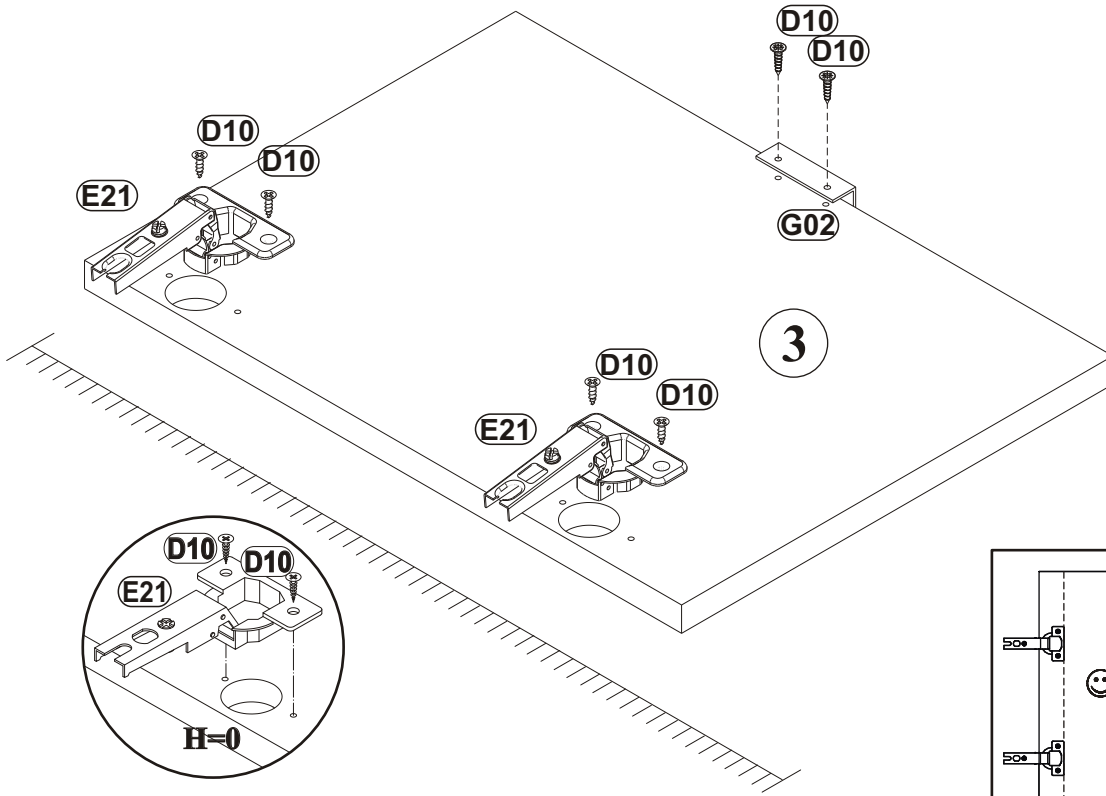

4

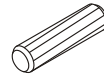
A1	
x4	ø8x36

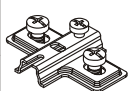
E2	
x2	H=0

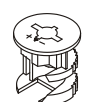
B5	
x4	ø15x12

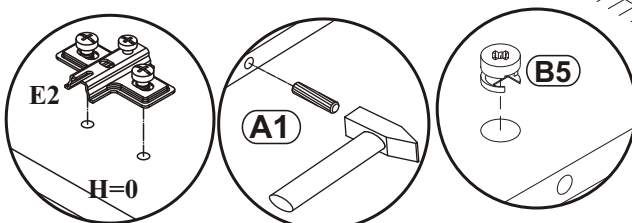
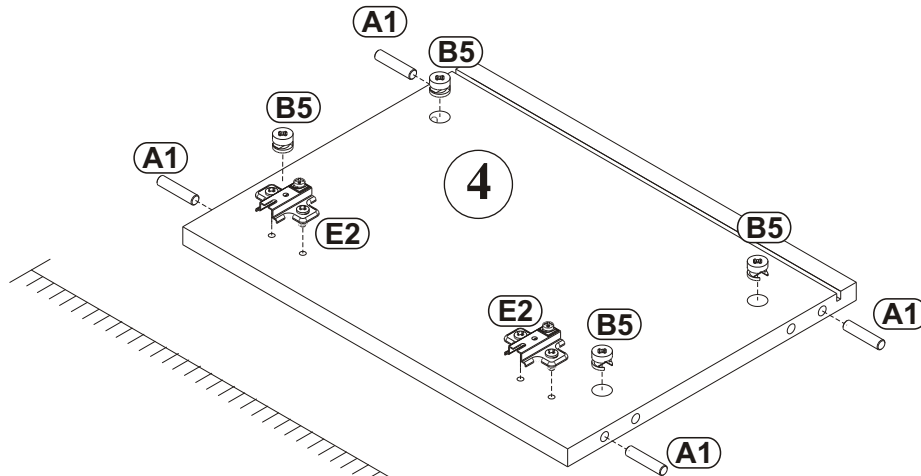

5

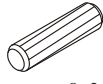
A1	
x4	ø8x36

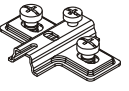
E2	
x2	H=0

B5	
x4	ø15x12

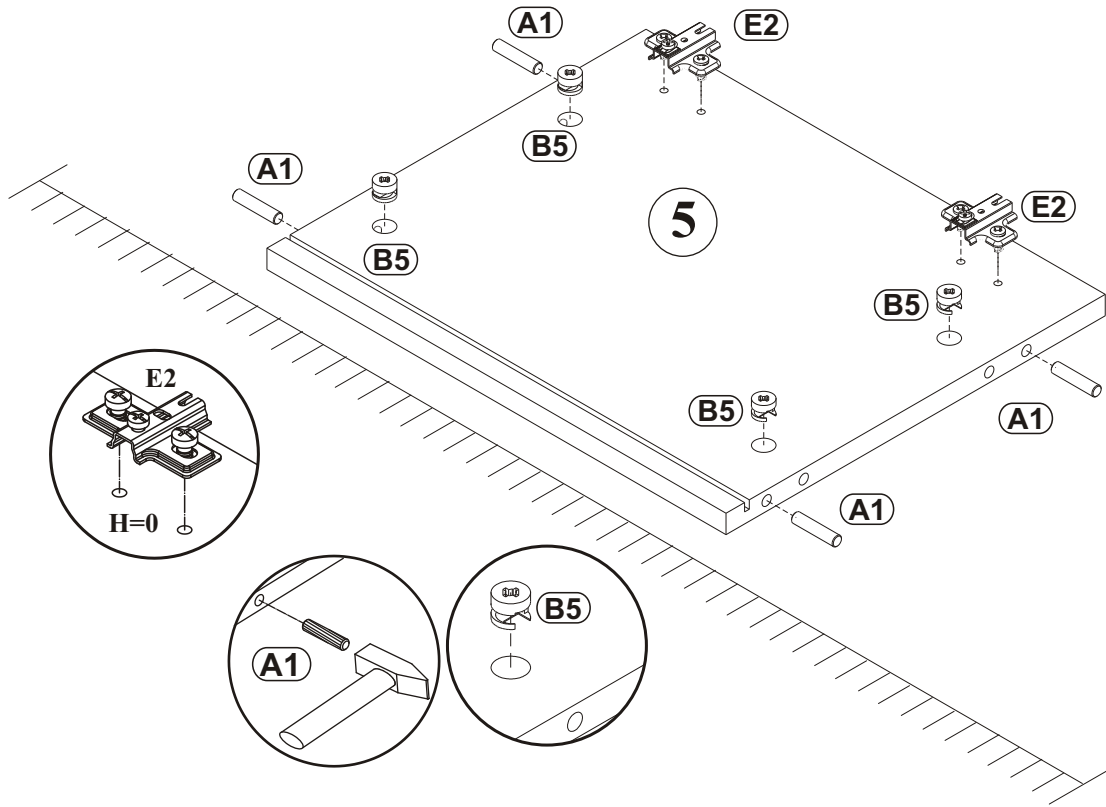

6

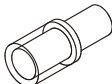
G20	
x2	

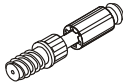
B4	
x4	34

UP17	
x4	UPØ4x25

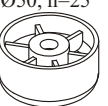
ST7	Ø50, h=25
x4	

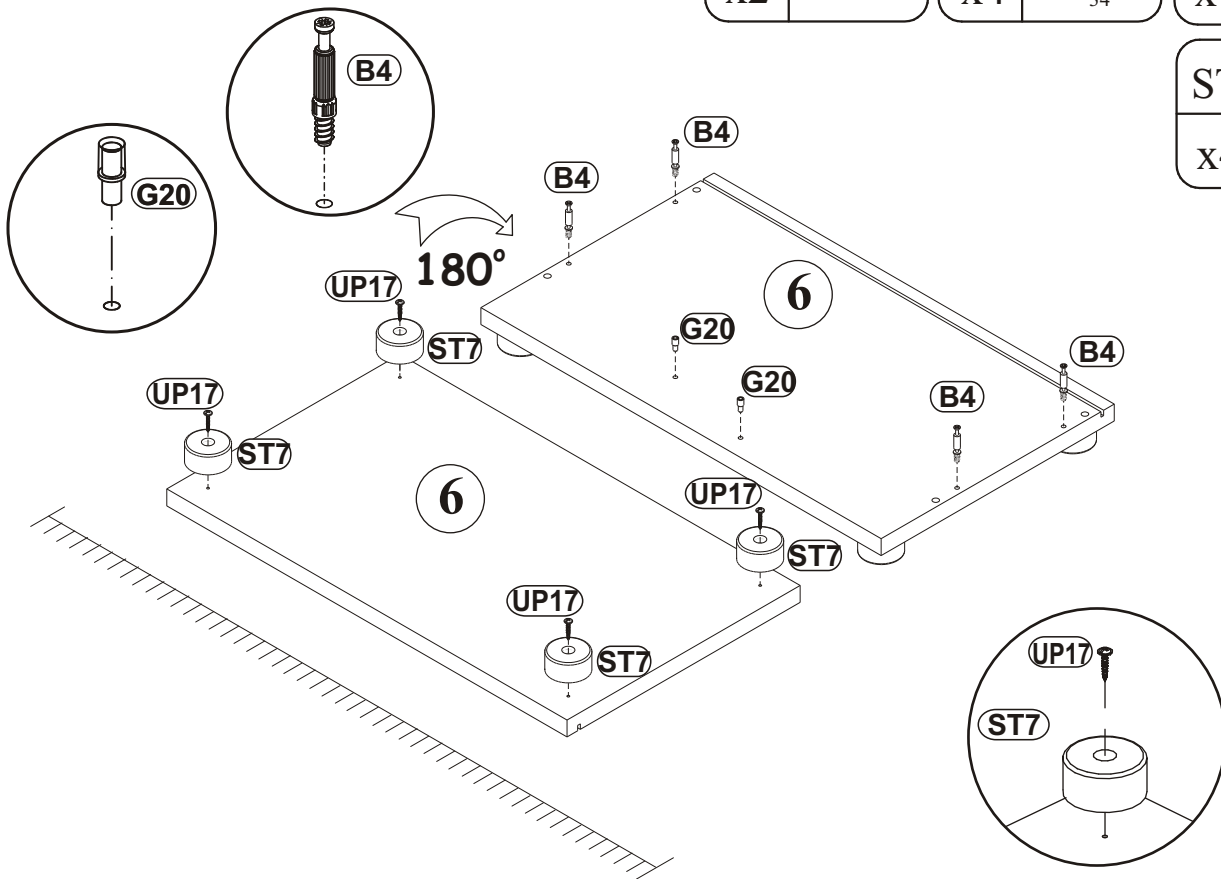

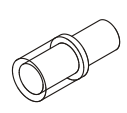
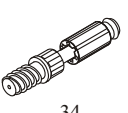

G20		B4	
x2		x4	34

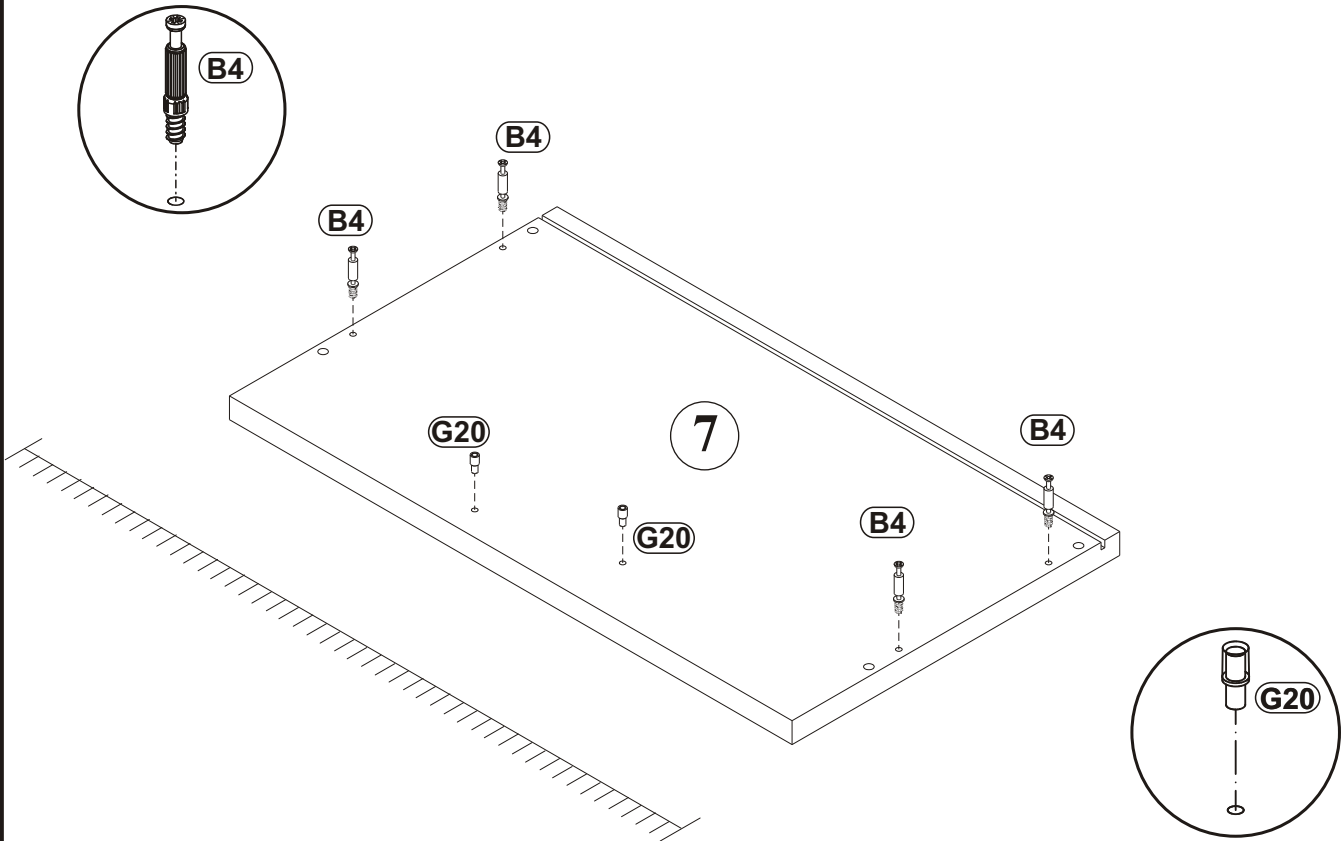
7

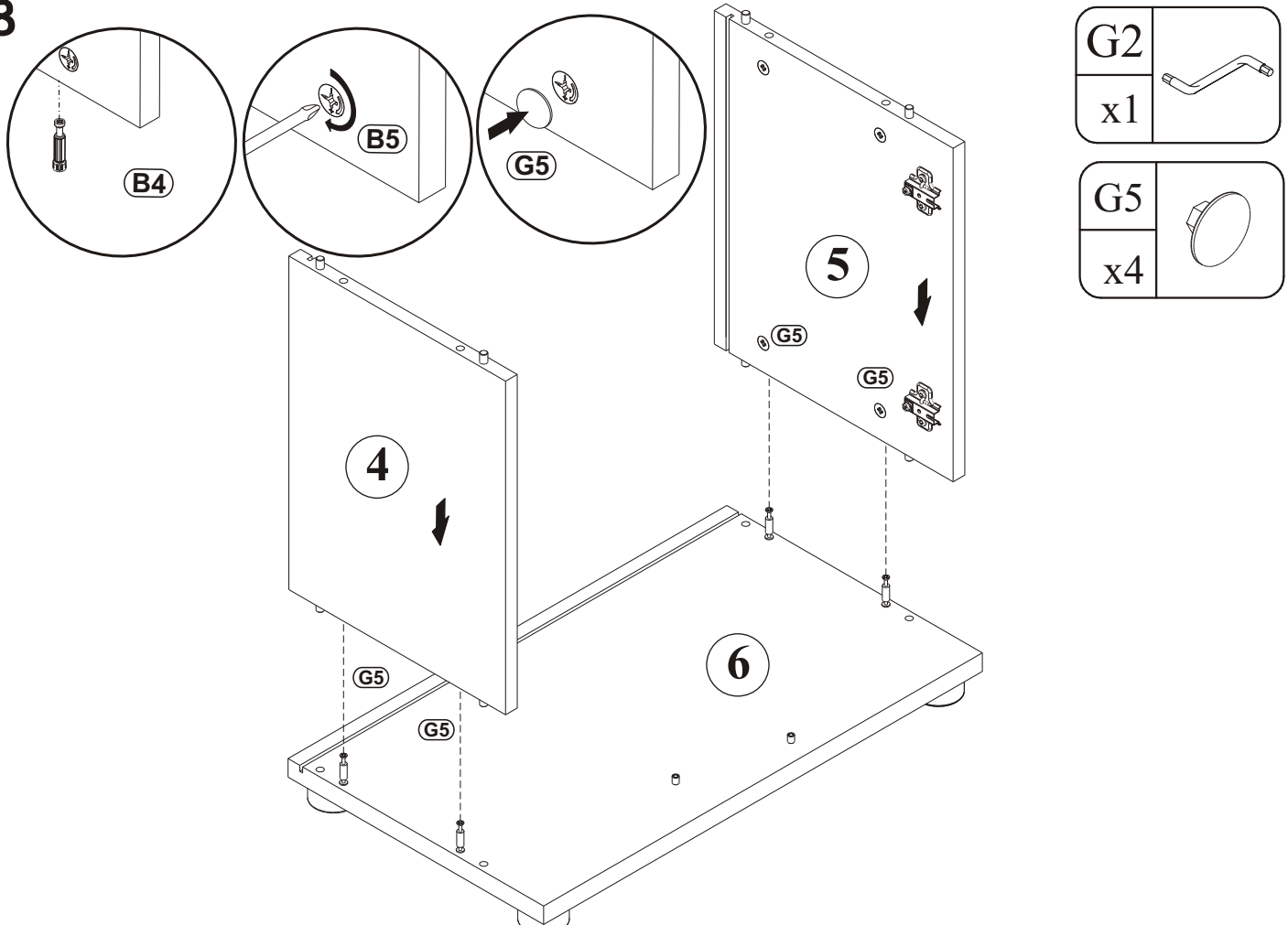

8



G2	
x1	
G5	
x4	

9

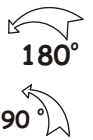
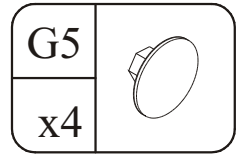
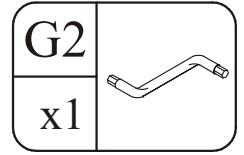
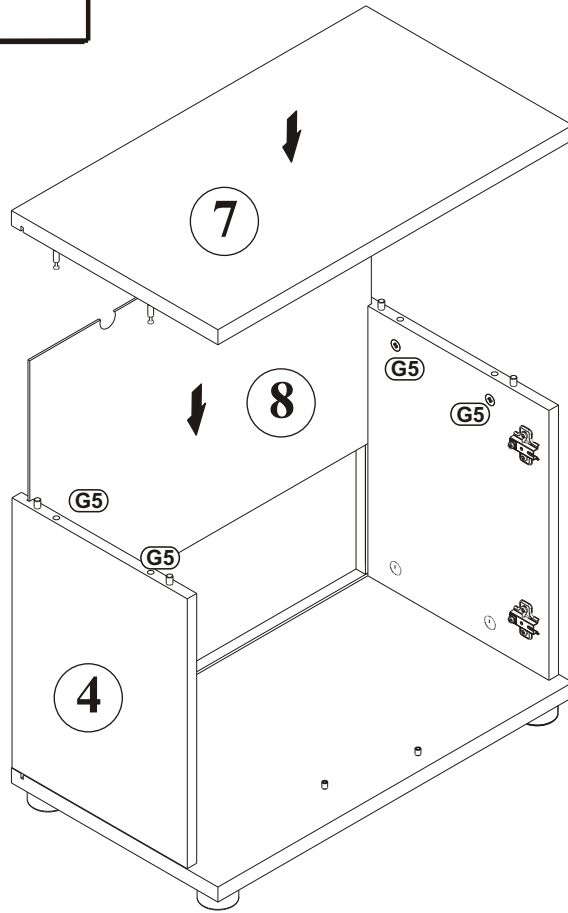
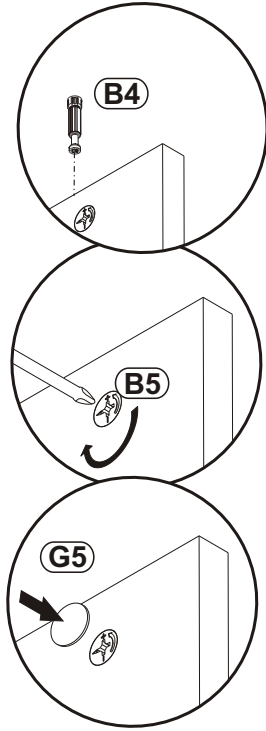

10

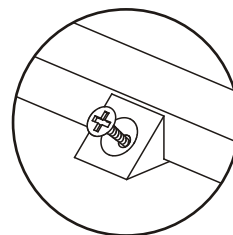
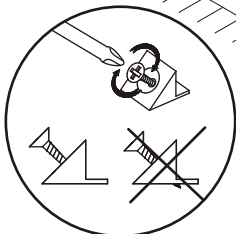
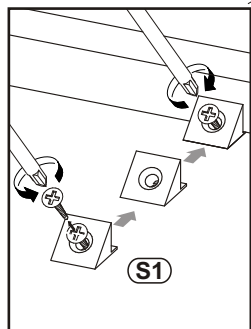
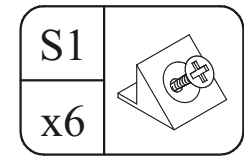
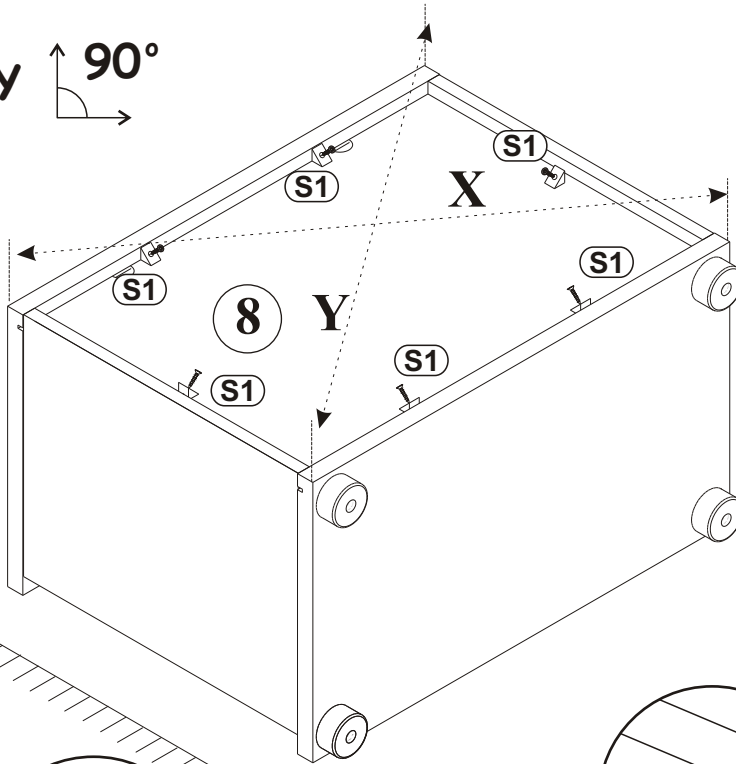

11

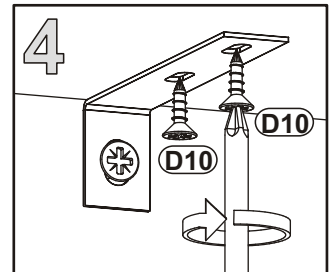
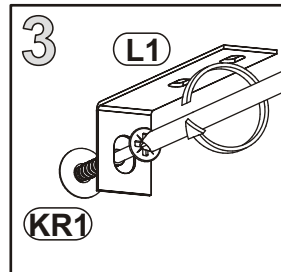
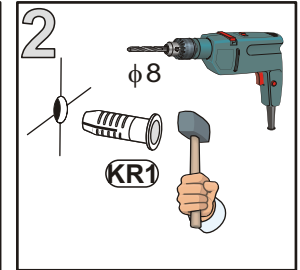
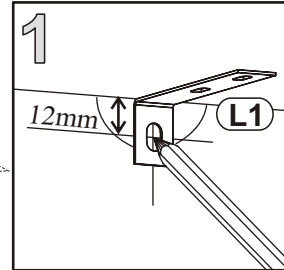
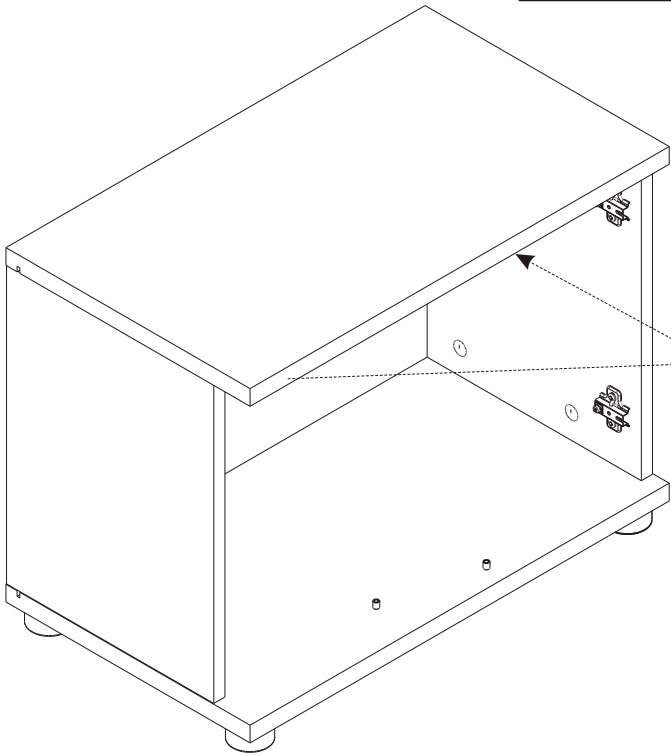
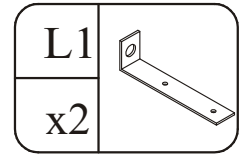
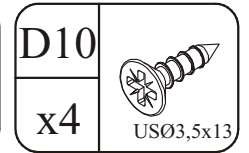
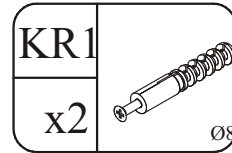
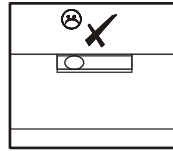
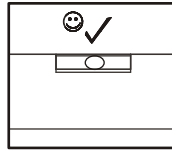

12

