

# PEDRO HJZ PD \_\_\_ TYP A

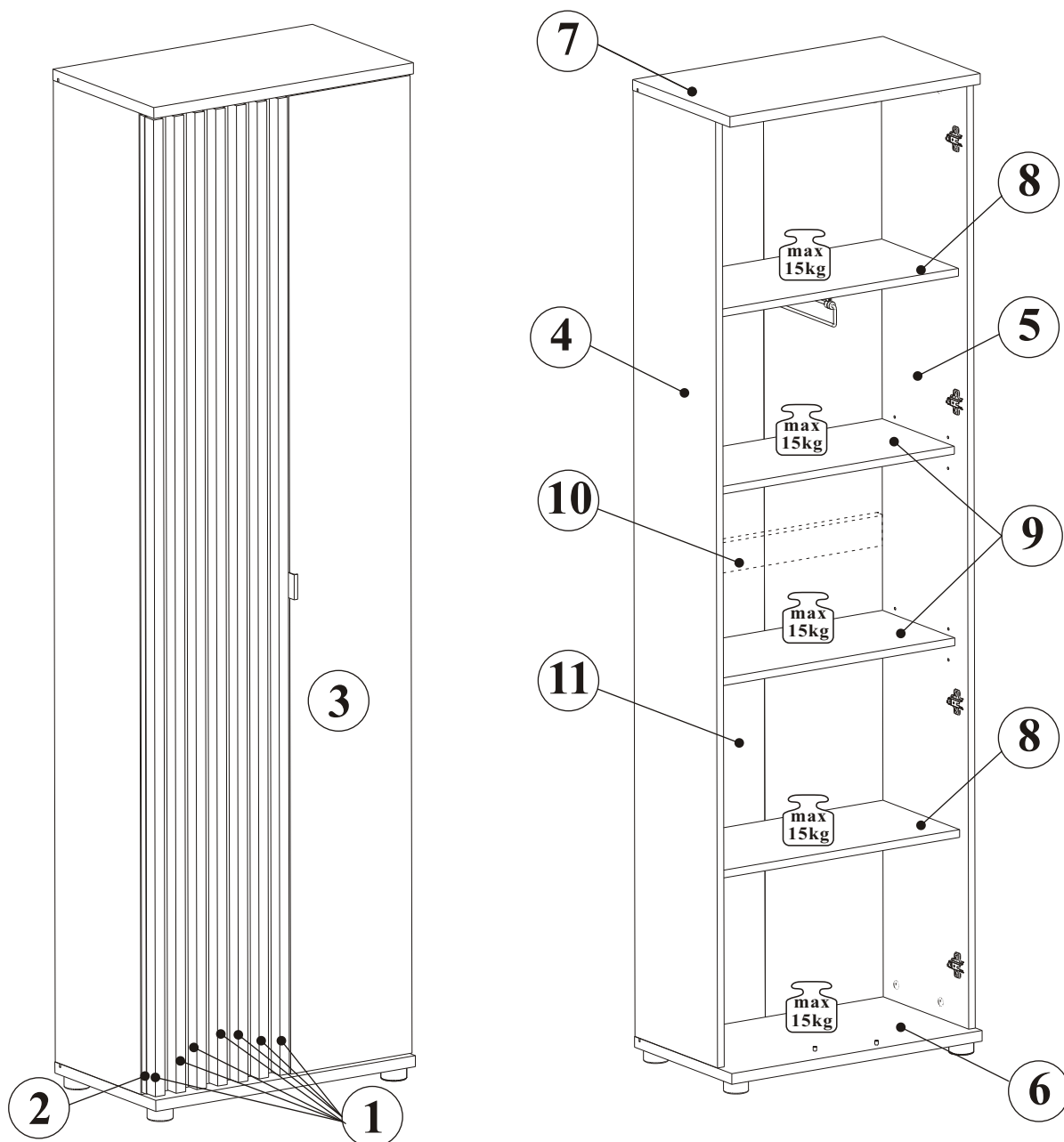

NO	DIM [mm]		COL.-NO	QTY
1	1946	30	22 1/2	7
2	312	1948	16 1/2	1
3	281	1948	16 1/2	1
4	1956	297	16 2/2	1
5	1956	327	16 2/2	1
6	601	350	22 2/2	1
7	601	350	22 2/2	1
8	567	276	16 2/2	2
9	567	260	16 2/2	2
10	567	60	16 2/2	1
11	1967	578	3 1/2	1

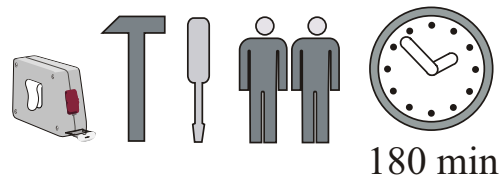



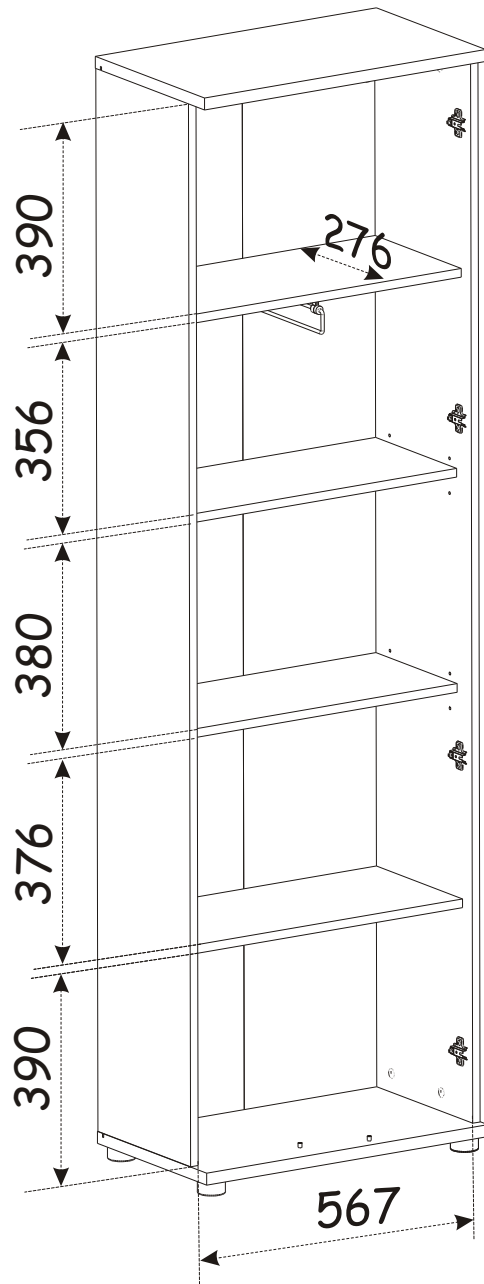
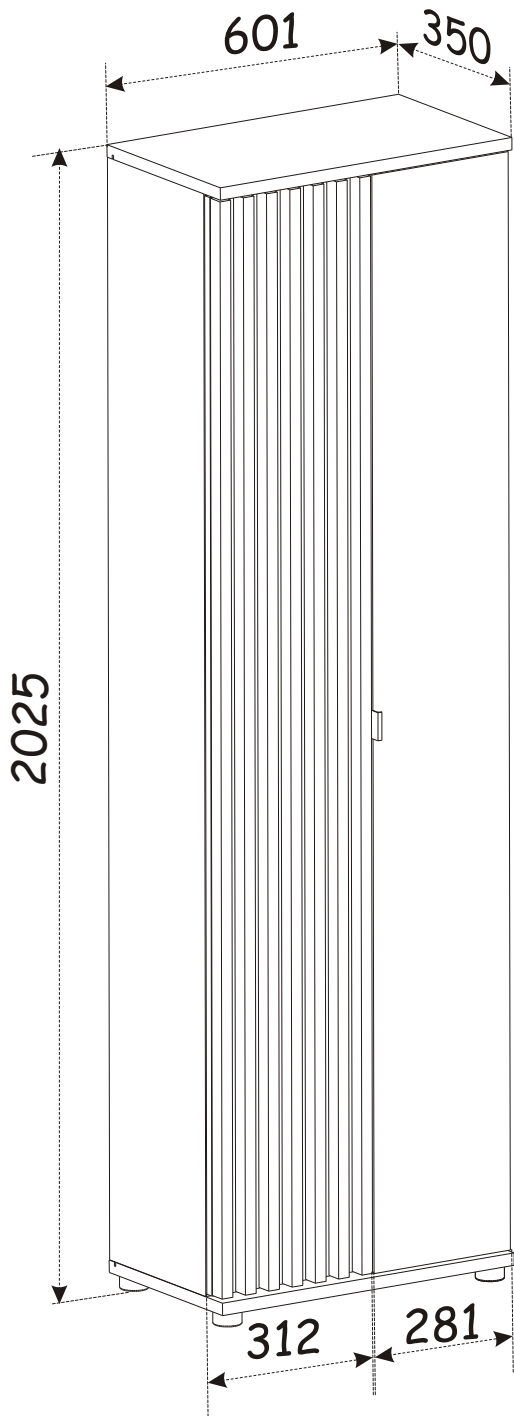

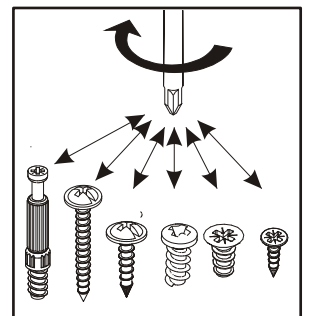
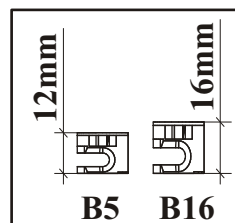
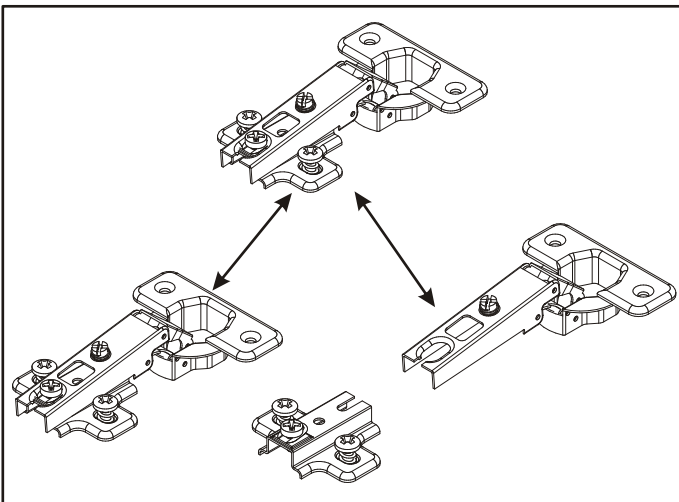
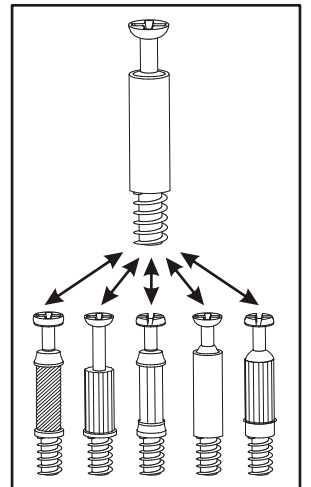
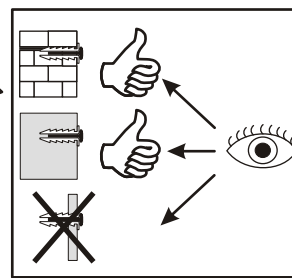
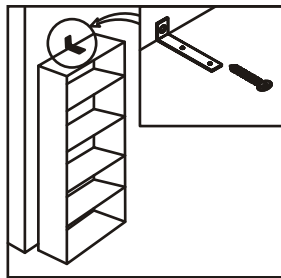
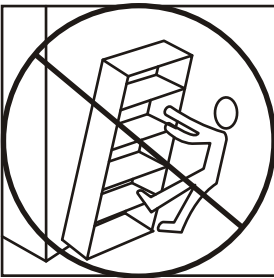
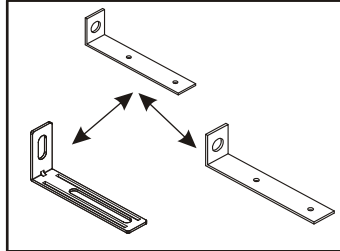
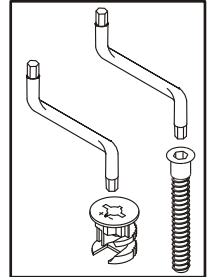
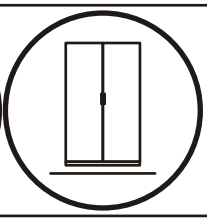
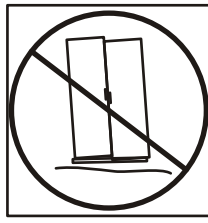
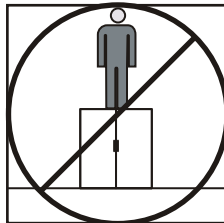
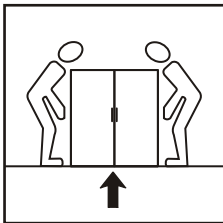
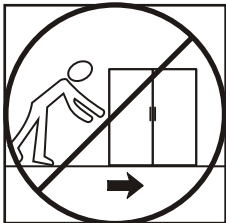
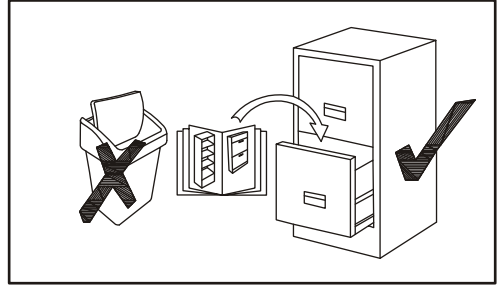
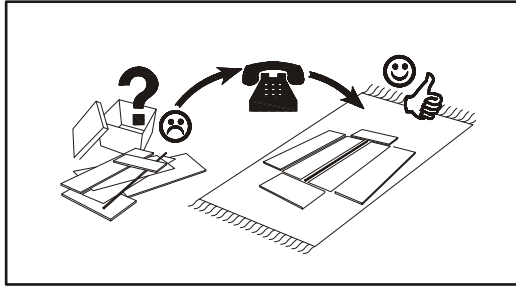
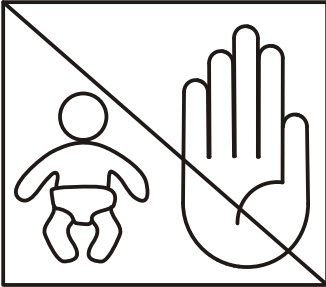
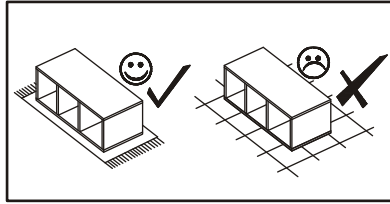
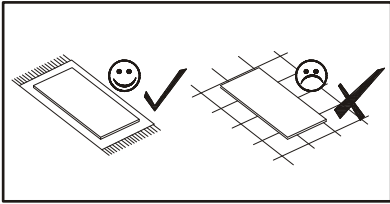



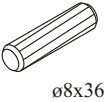

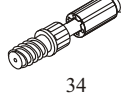
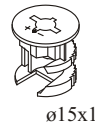
# PEDRO HJZ PD \_ TYP A

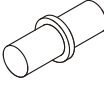
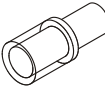
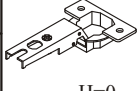
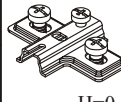
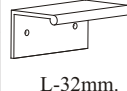

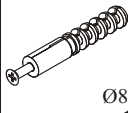
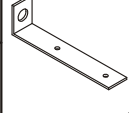
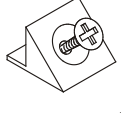
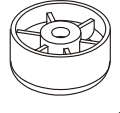
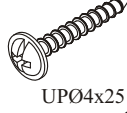

PEDRO HJZ PD \_ TYP A

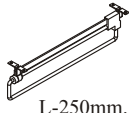
A1 x20  ø8x36	B22 x35  Ø7x40	G4 x30 	B4 x16  34	B5 x16  ø15x12	G5 x16 
G7 x8 	G20 x4 	E21 x8  Ø35 H=0	E2 x8  H=0	G02 x1  L-32mm.	G12 x5  Ø14
KR1 x2  Ø8	L1 x2 	S1 x16 	ST7 x4  Ø50, h=25	UP17 x4  UPØ4x25	D10 x22  USØ3,5x13
UP9 x16  UPØ3,5x16	G2 x1 	C6 x1  L-250mm.			

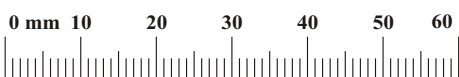



PEDRO HJZ PD \_ TYP A

1

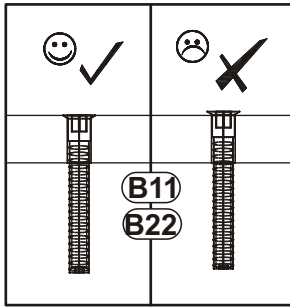
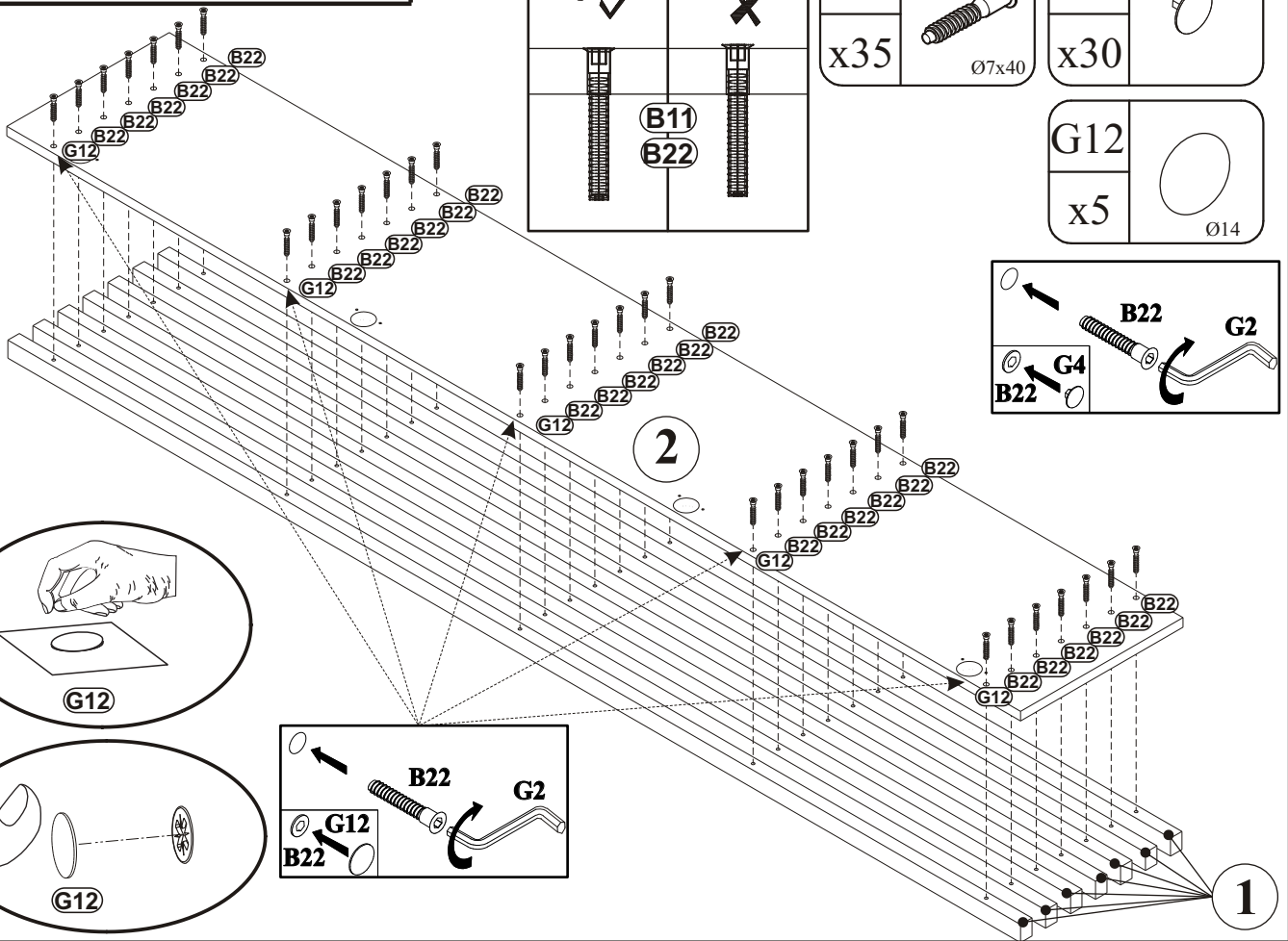

B22	
x35	Ø7x40

G4	
x30	

G12	
x5	Ø14

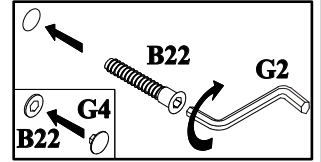

2

2

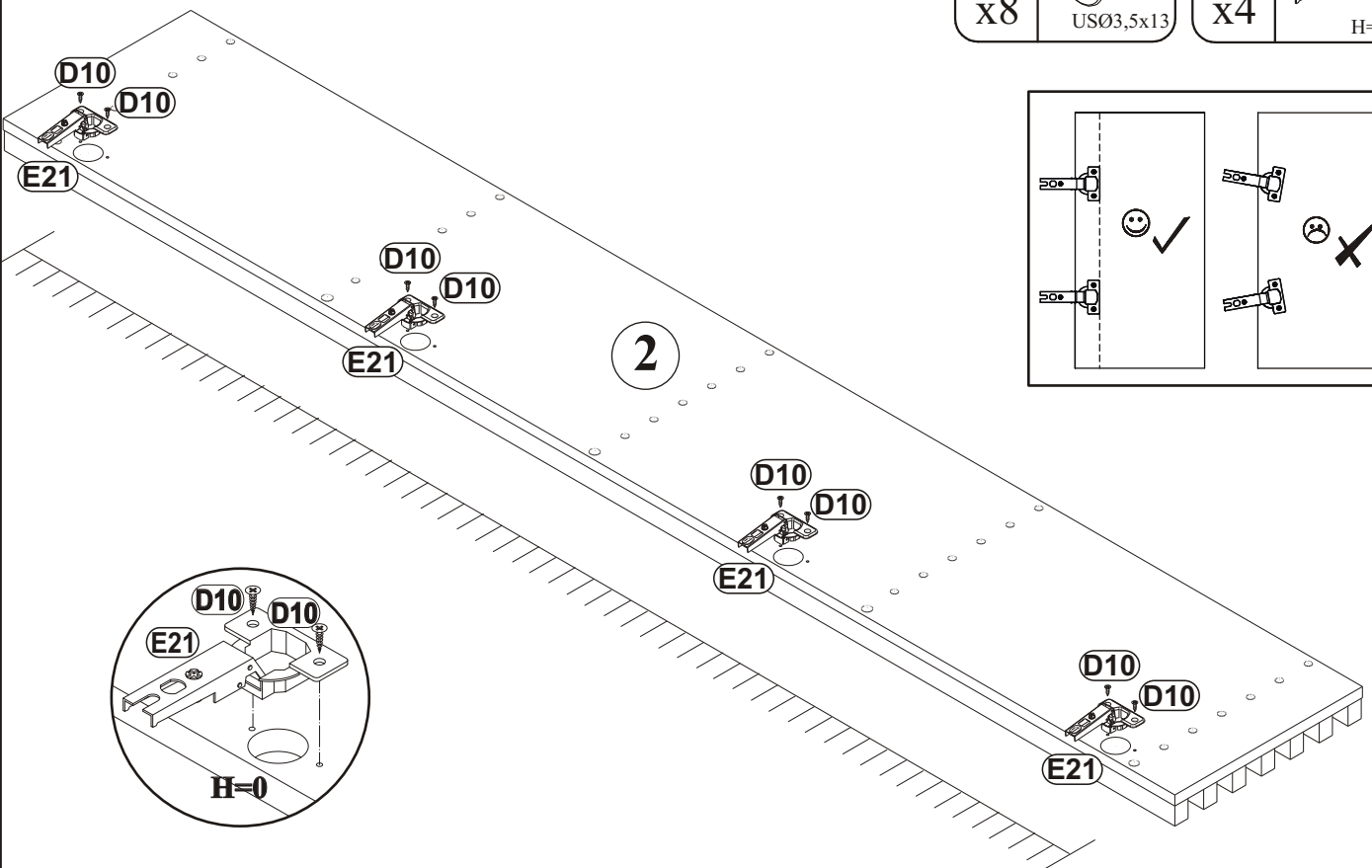

D10	
x8	USØ3,5x13

E21	
x4	Ø35 H=0

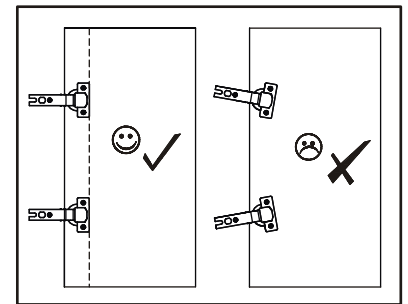

D10	
x10	USØ3,5x13

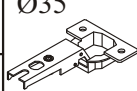
E21	
x4	Ø35 H=0

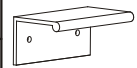
G02	
x1	L-32mm.

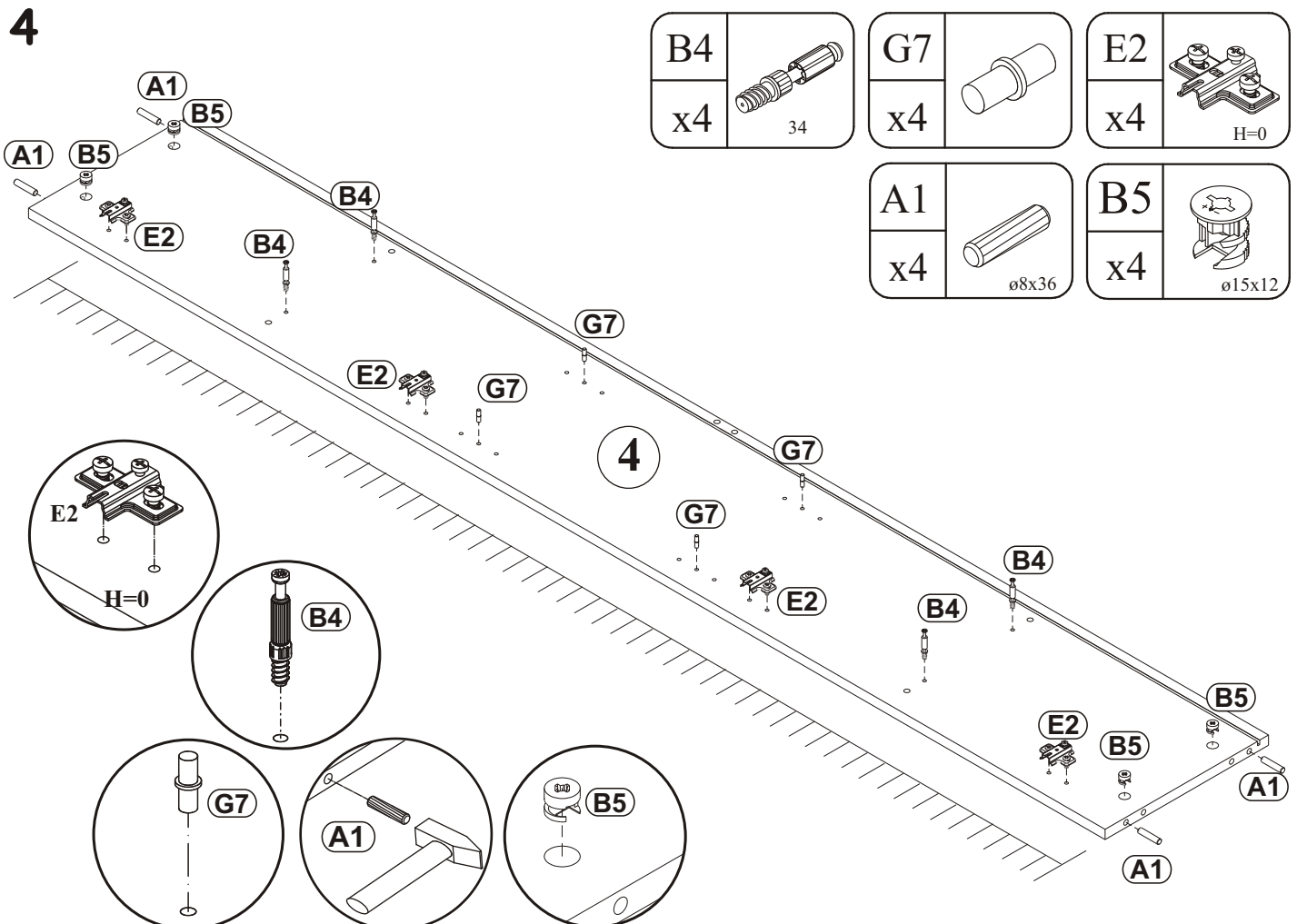
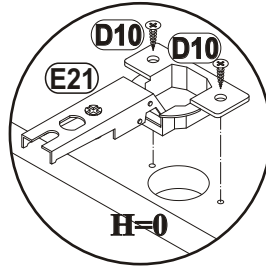
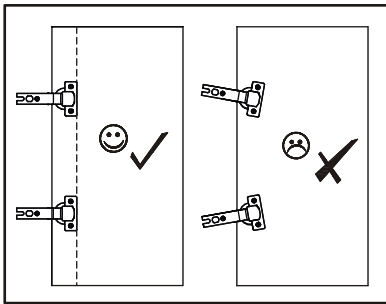
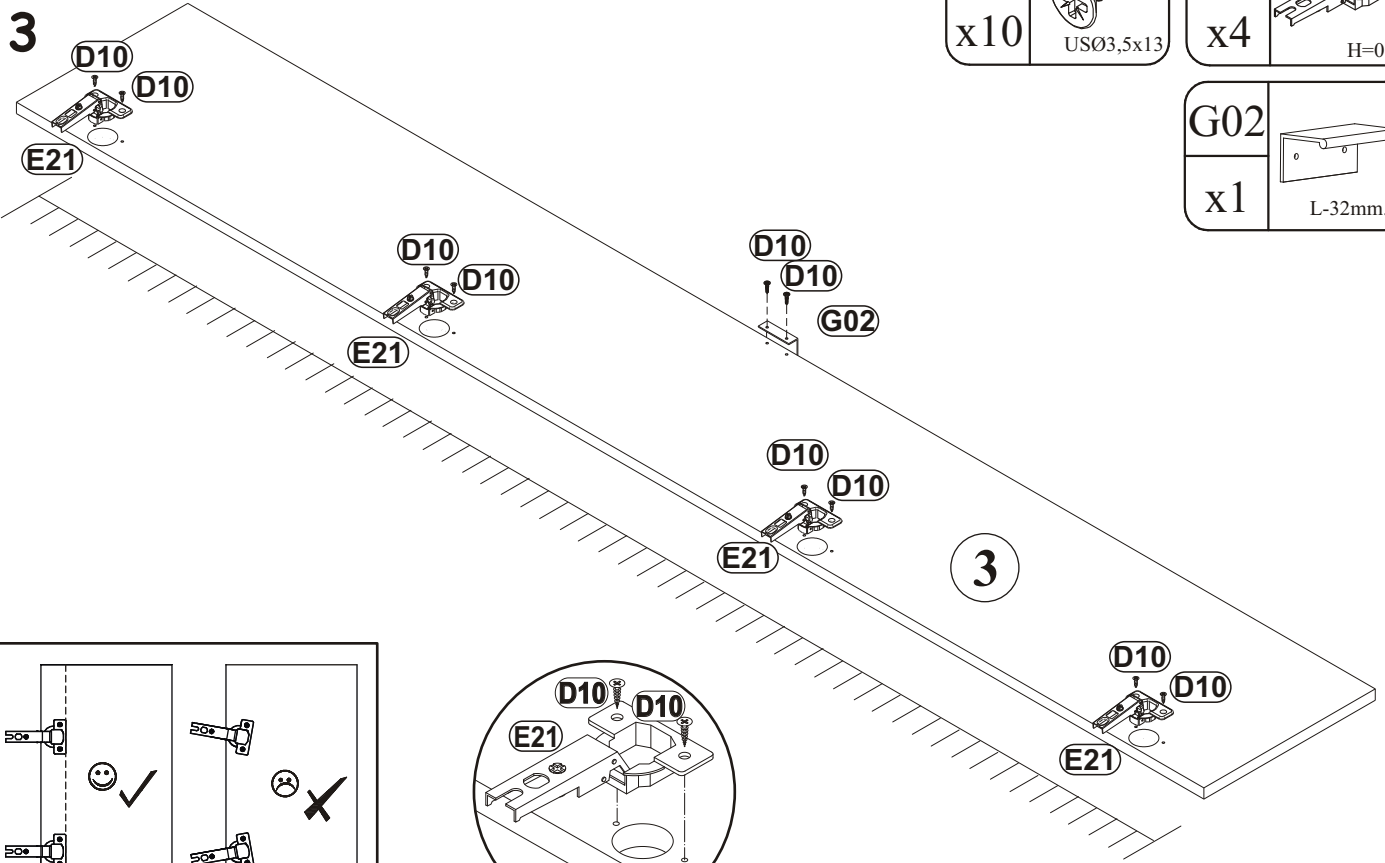

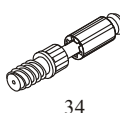
B4	
x4	34

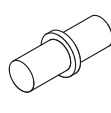
G7	
x4	

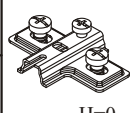

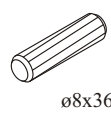
E2	
x4	H=0

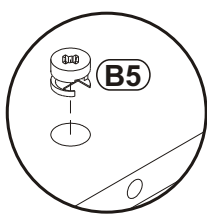
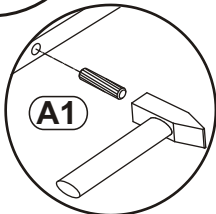
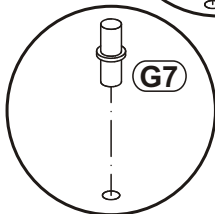
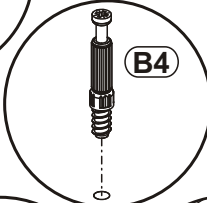
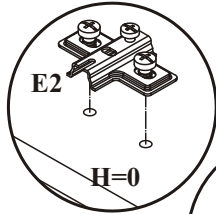

A1	
x4	ø8x36

B5	
x4	ø15x12

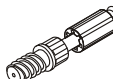

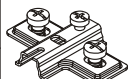

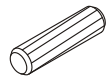
5

B4		G7		E2	
x4	34	x4		x4	H=0

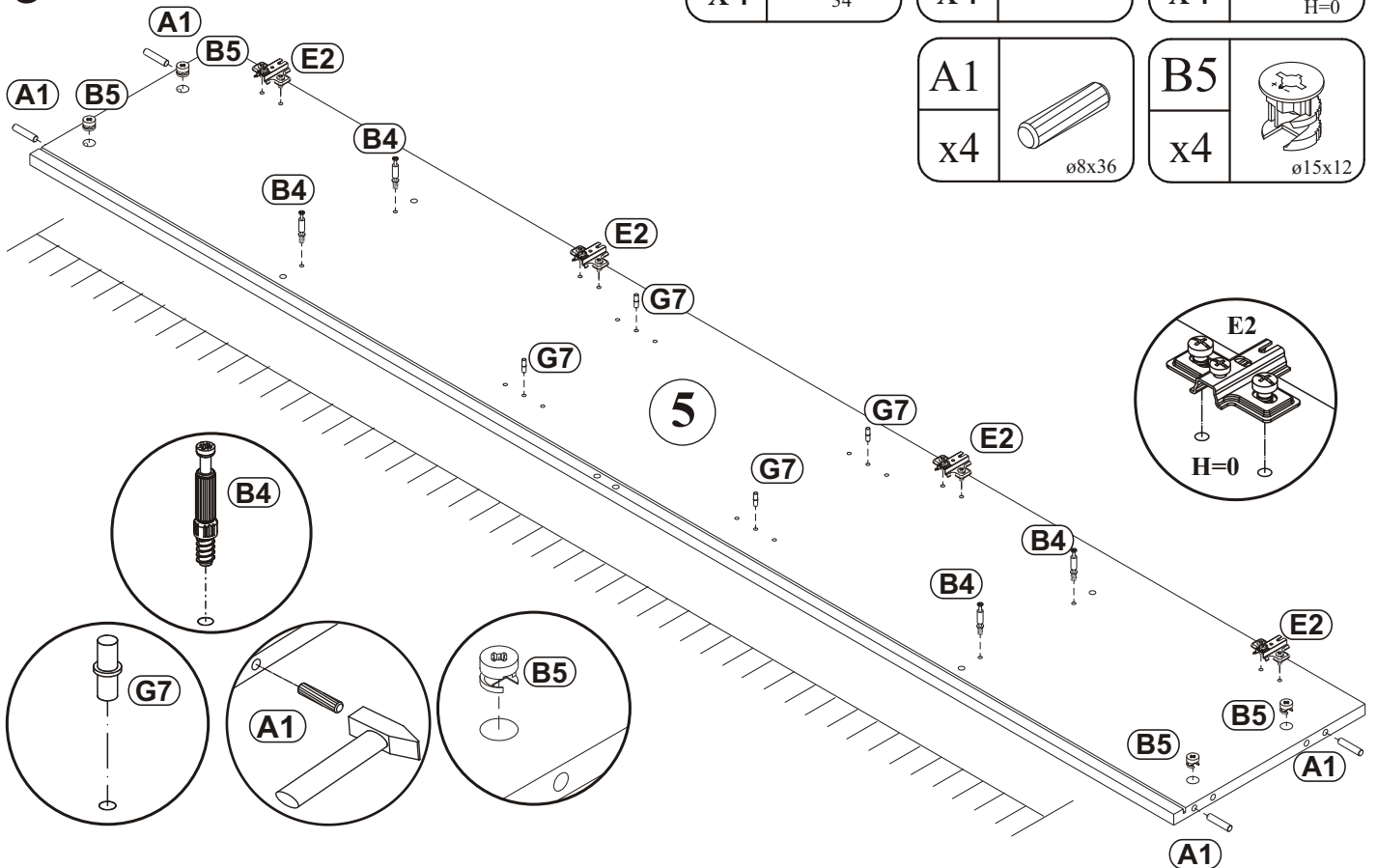
A1		B5	
x4	ø8x36	x4	ø15x12

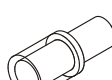
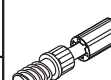

6

G20		B4		UP17	
x2		x4	34	x4	UPØ4x25

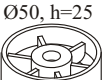
ST7	
x4	Ø50, h=25

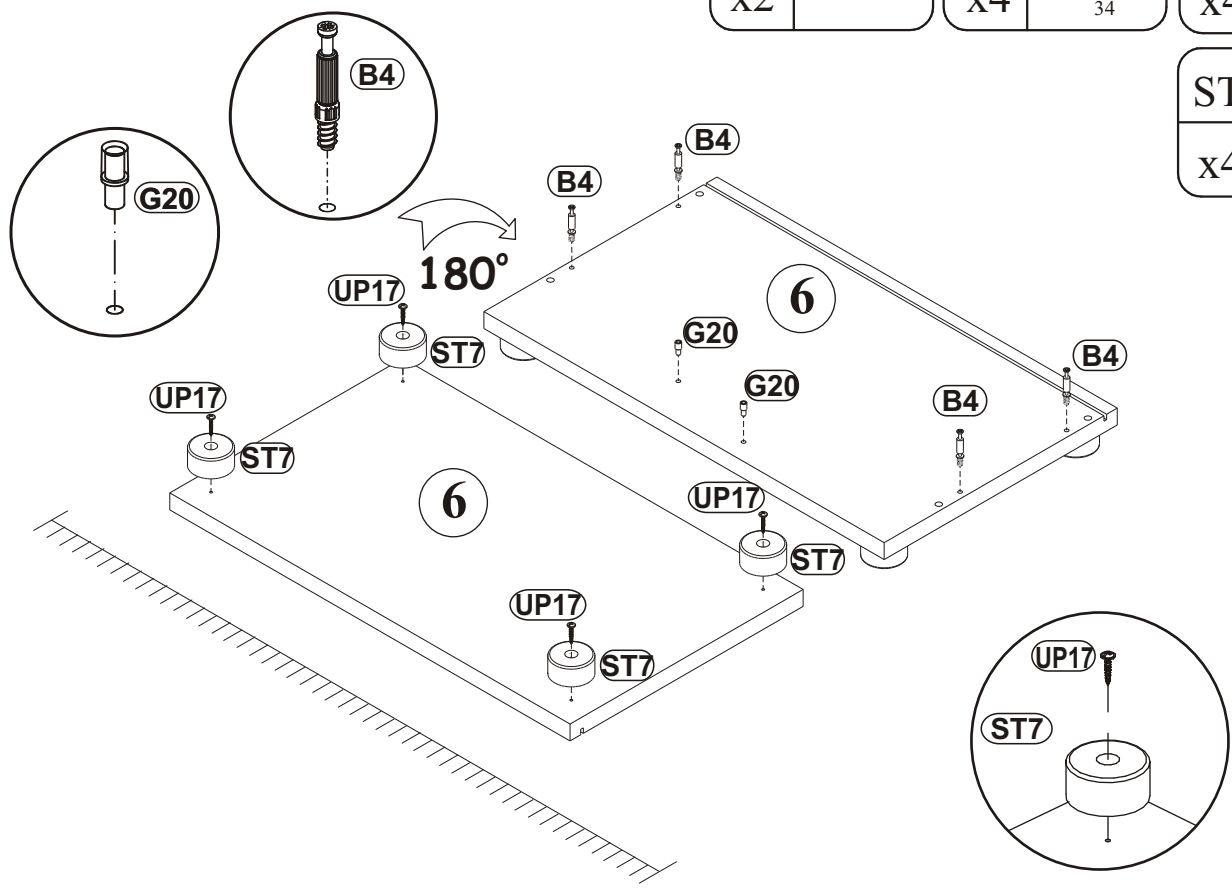

7

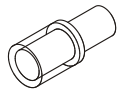
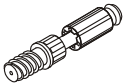

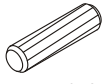
G20		B4	
x2		x4	34

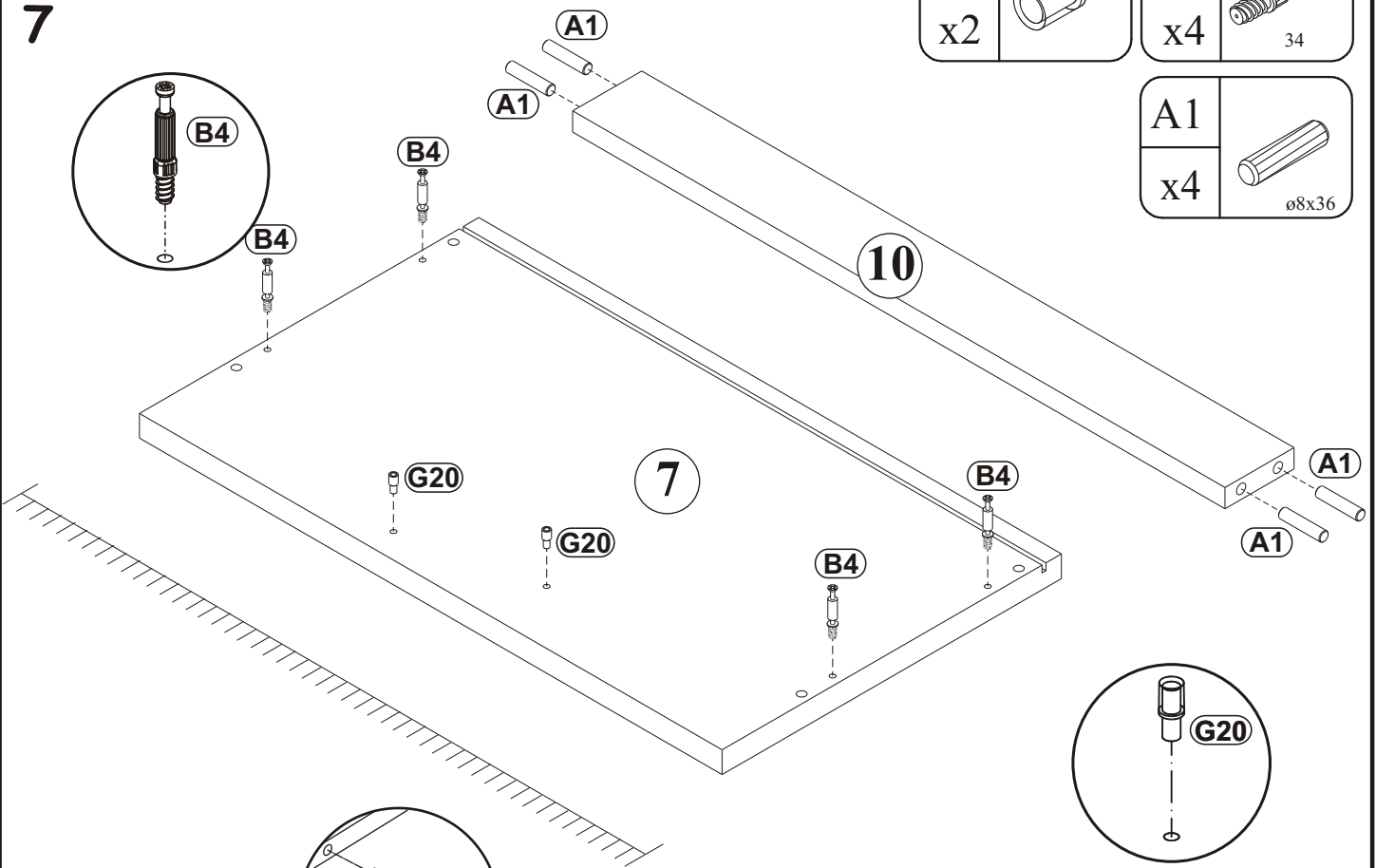
A1	
x4	ø8x36

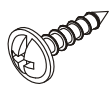
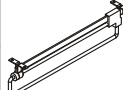

8

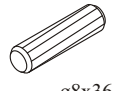
UP9		C6	
x4	UPØ3,5x16	x1	L-250mm.

A1		B5	
x8	ø8x36	x8	ø15x12

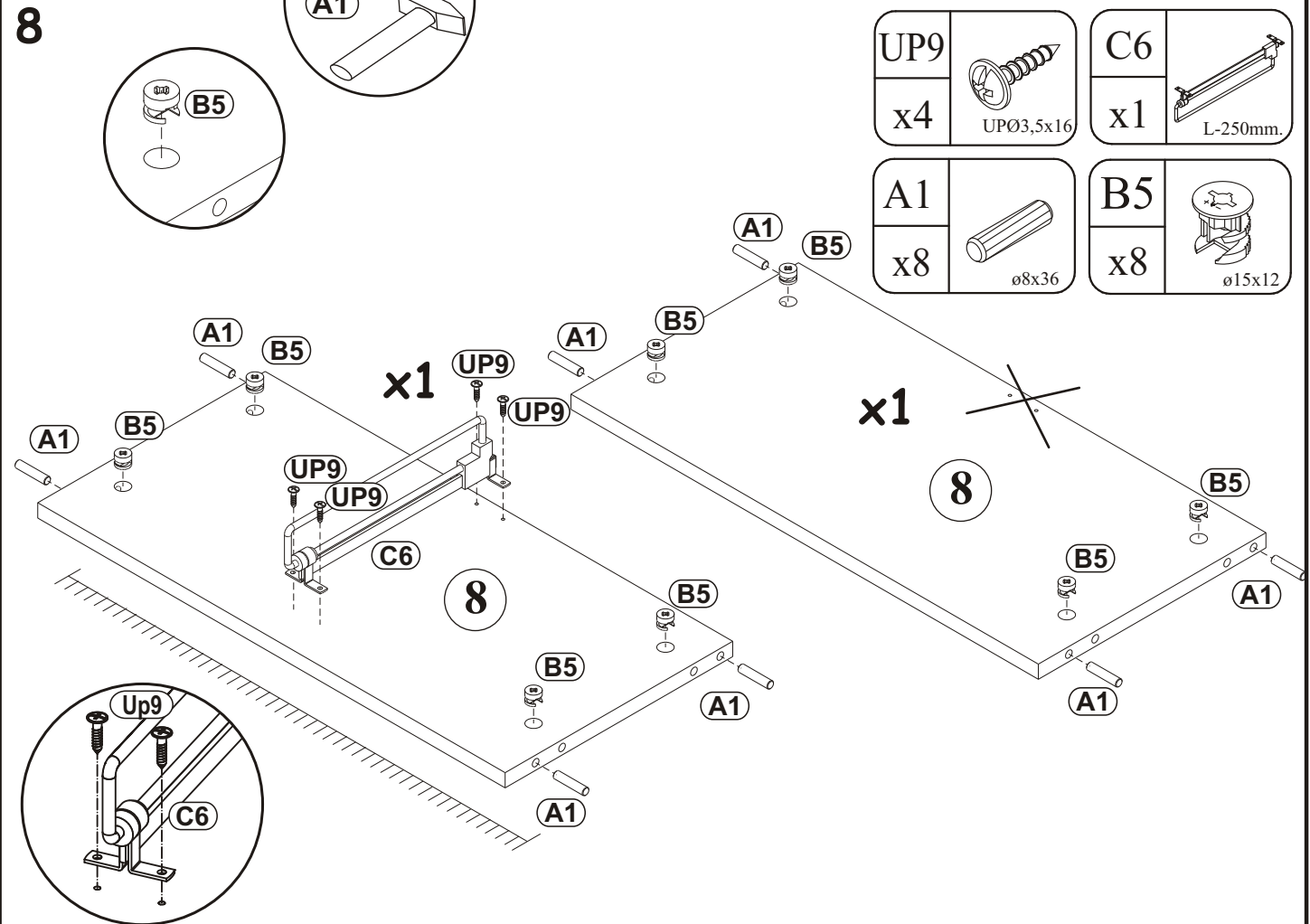

9

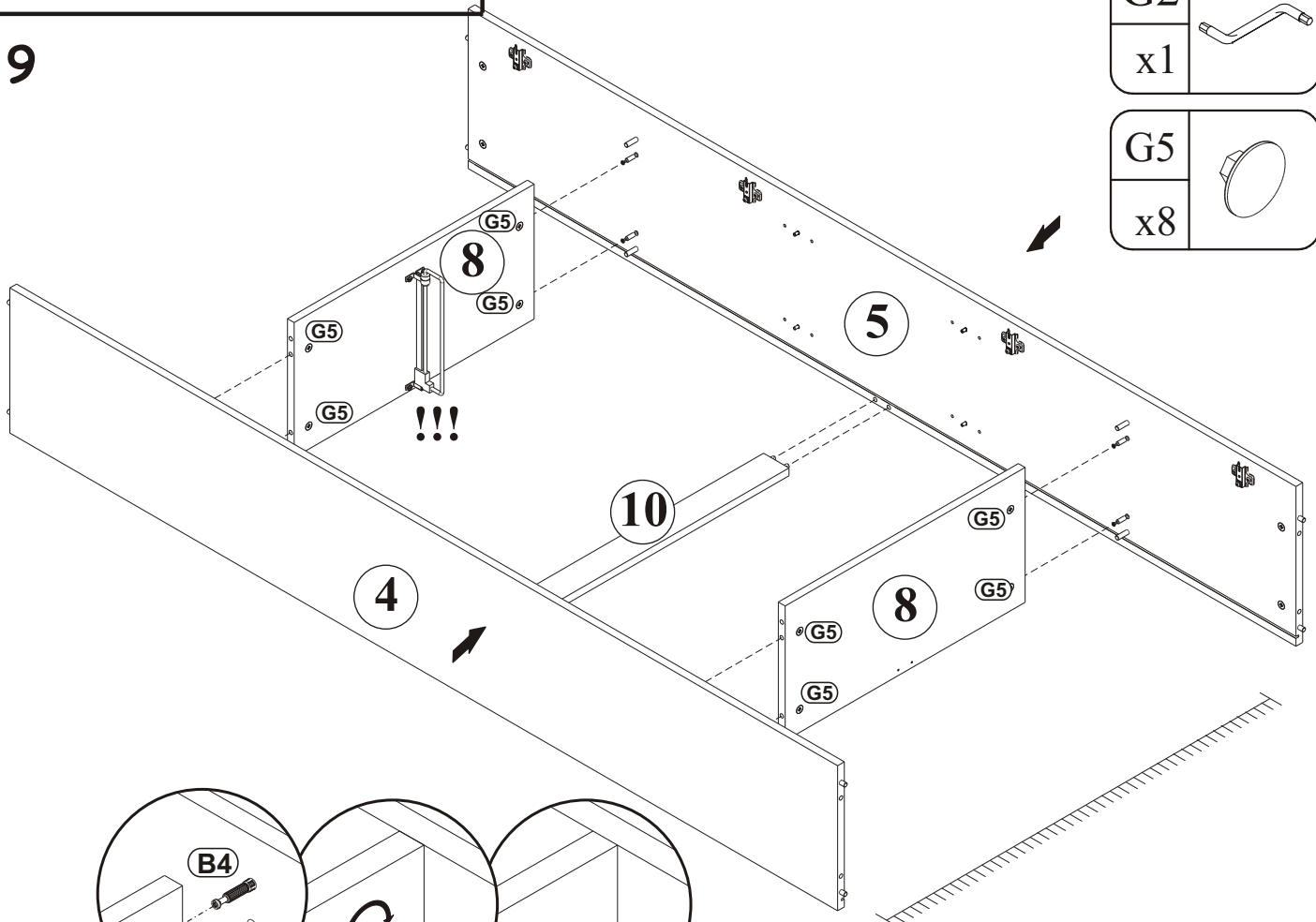

G2	
x1	

G5	
x8	

10

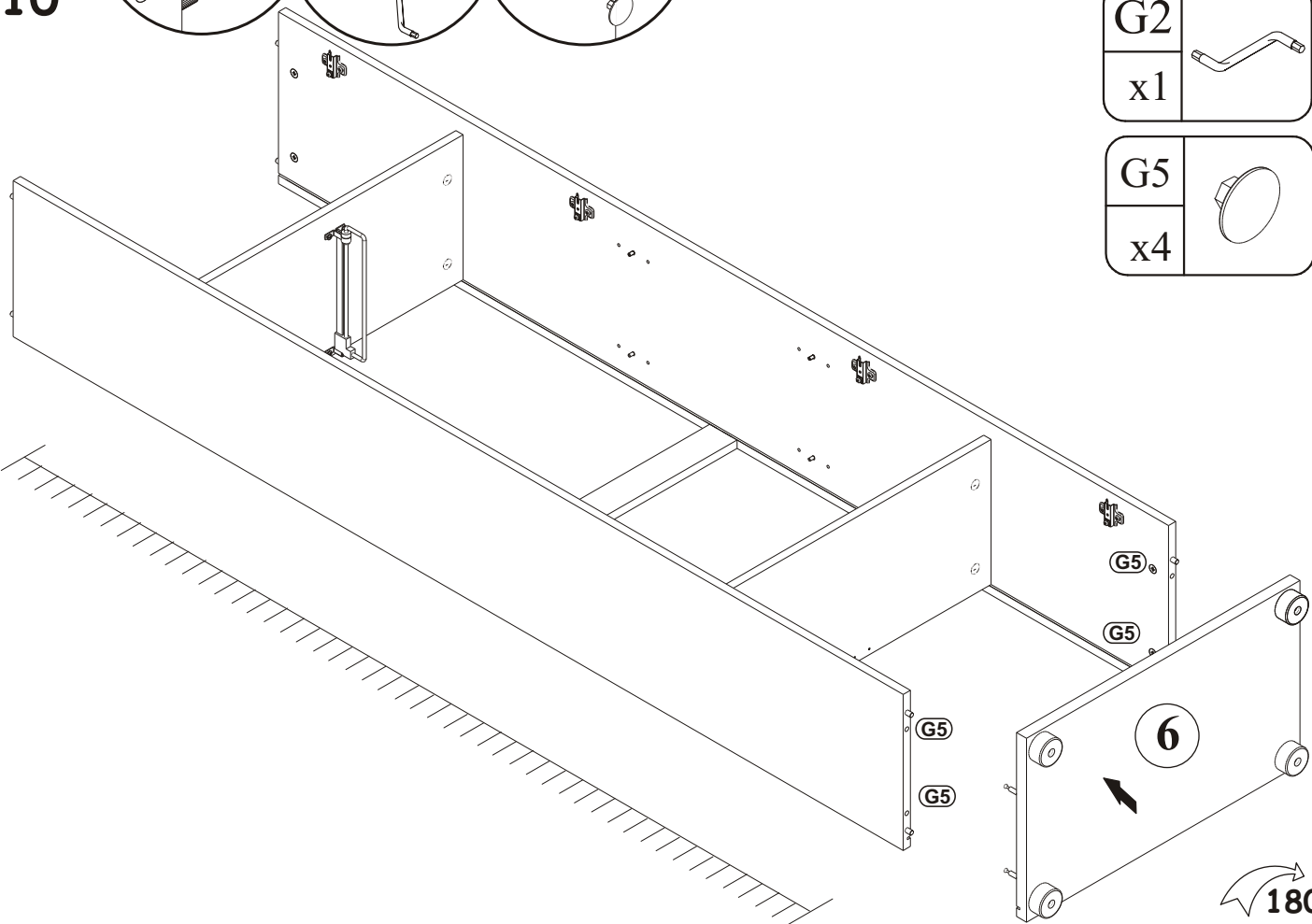
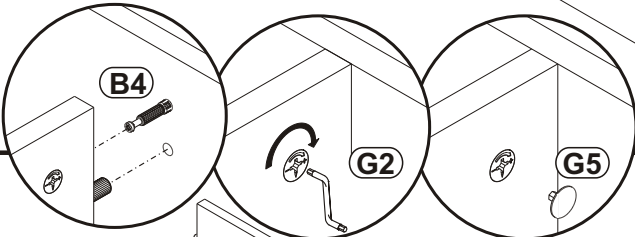

G2	
x1	

G5	
x4	

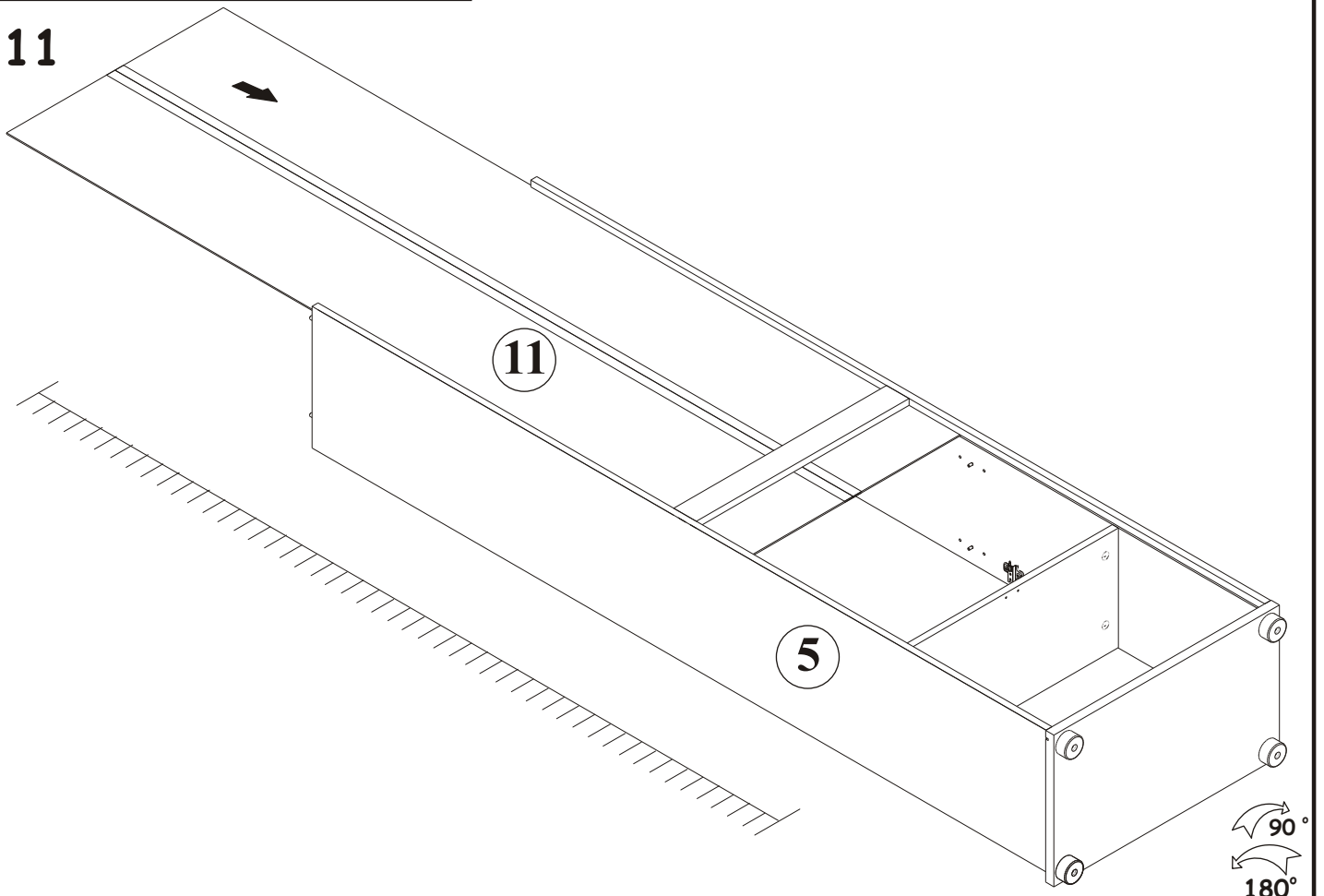

180°

11

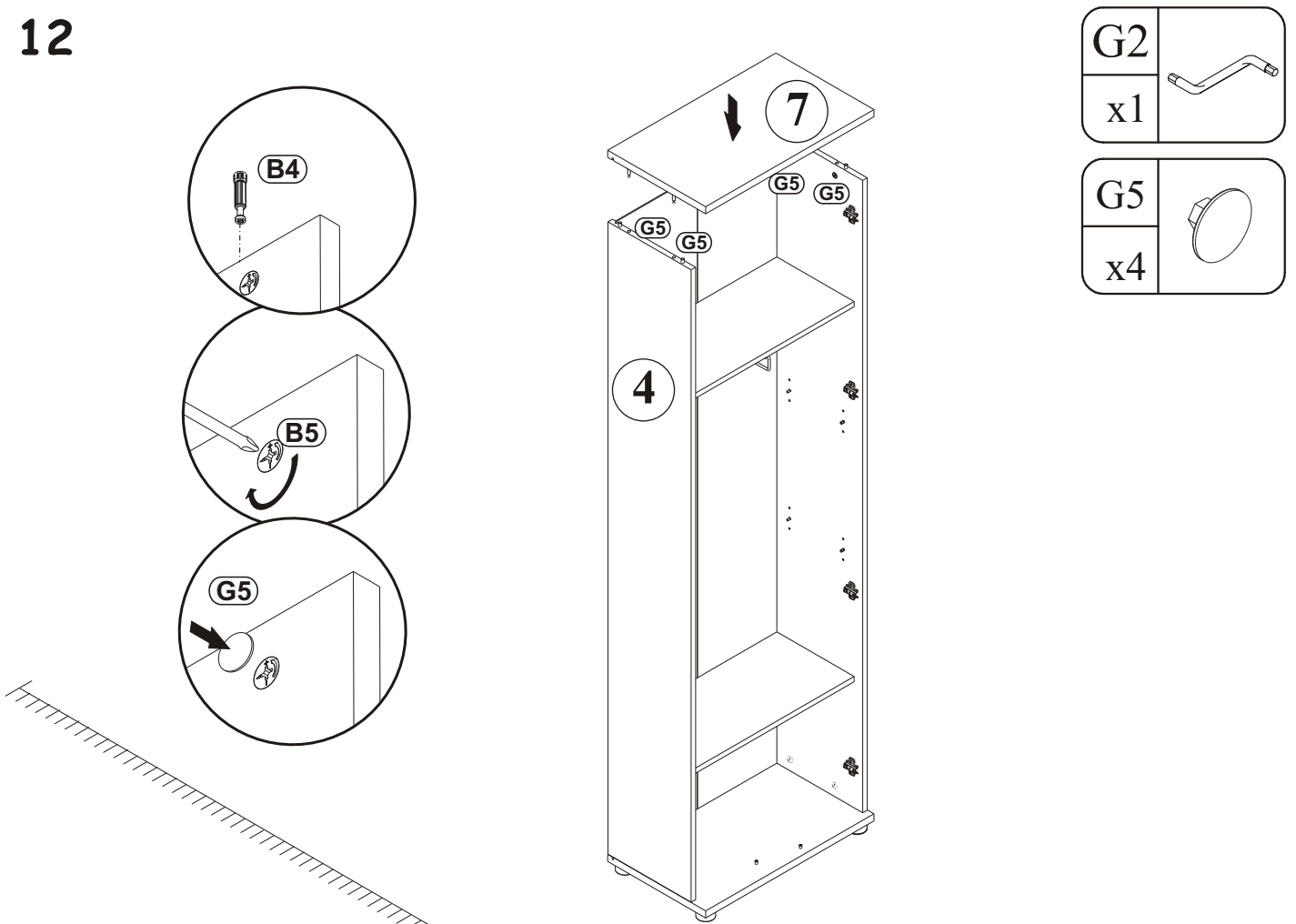

12

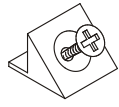

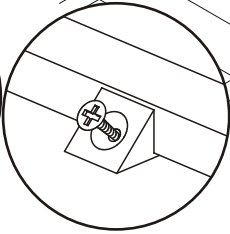
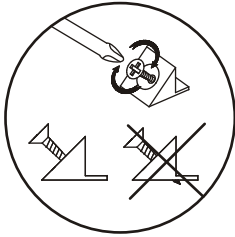
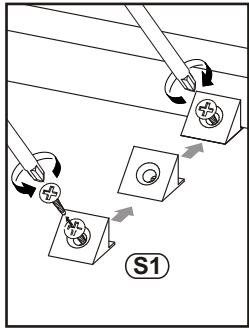
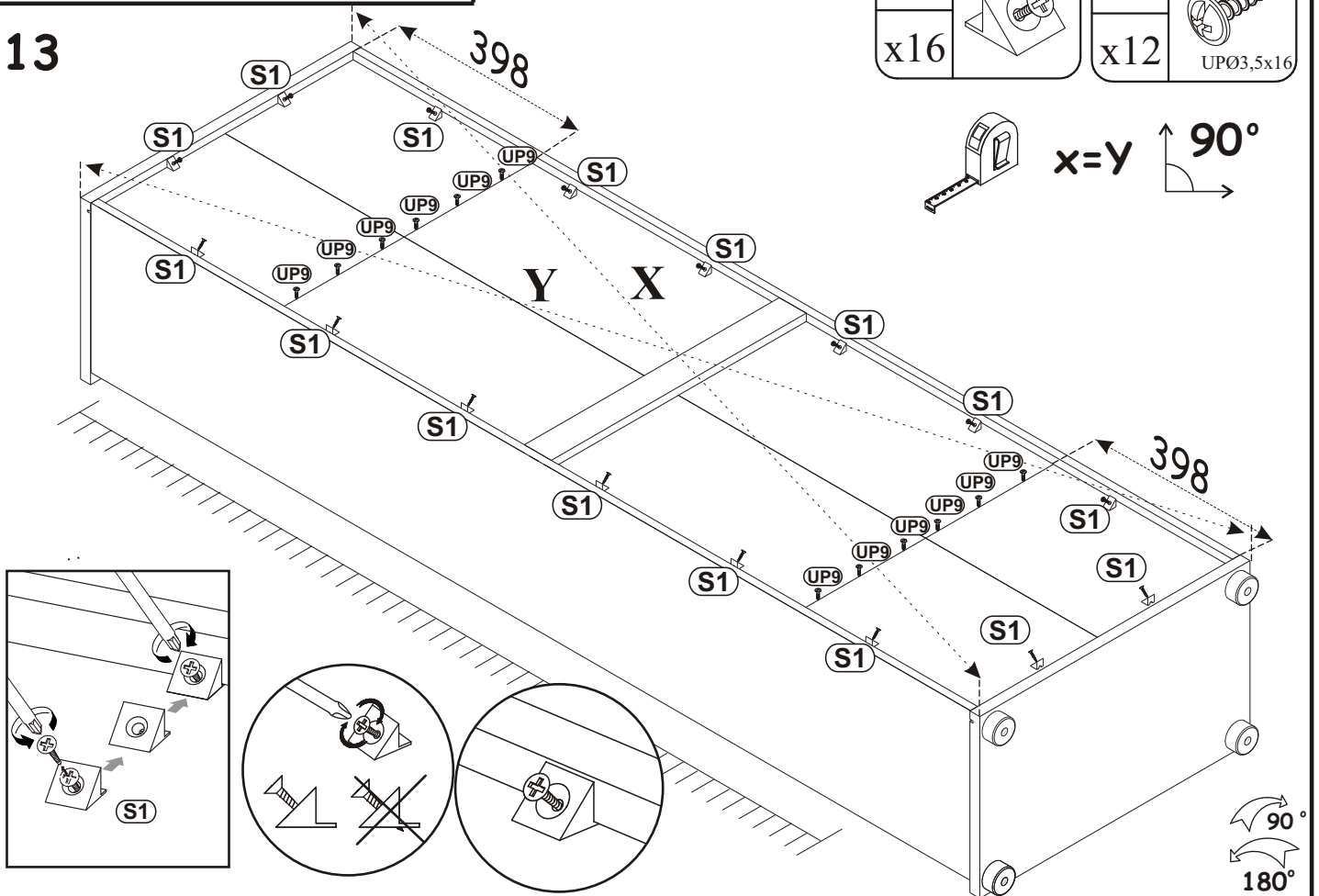

S1		UP9	
x16		x12	UPØ3,5x16

13

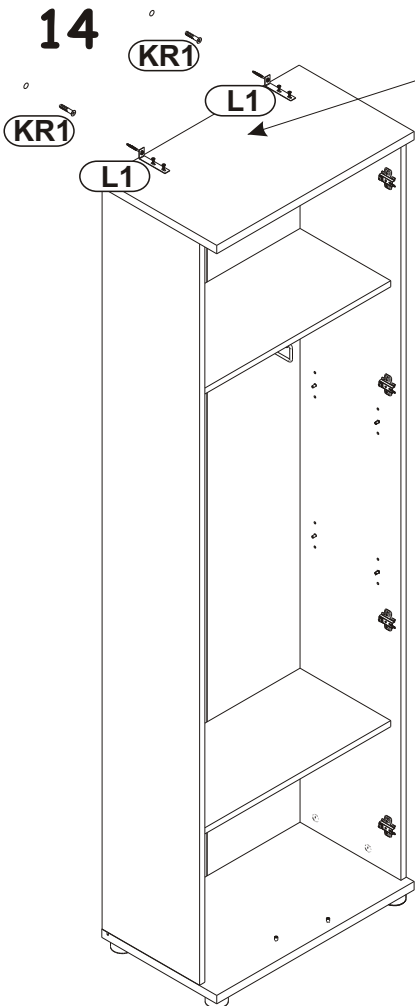

14

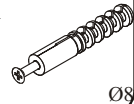

KR1		D10	
x2	Ø8	x4	USØ3,5x13

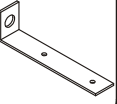
L1	
x2	

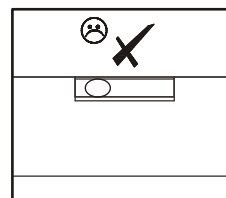
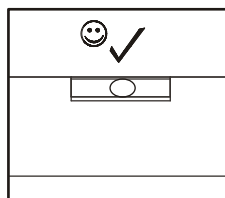
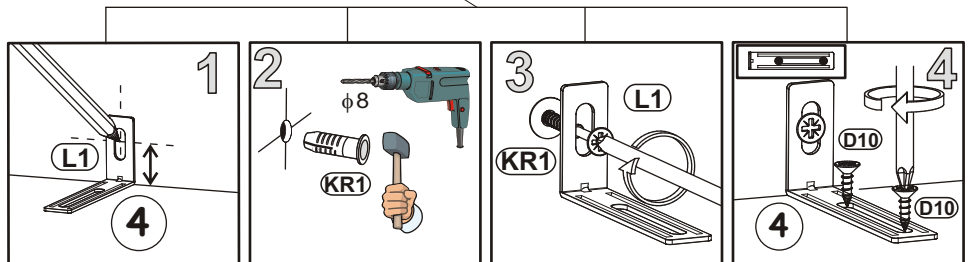



15

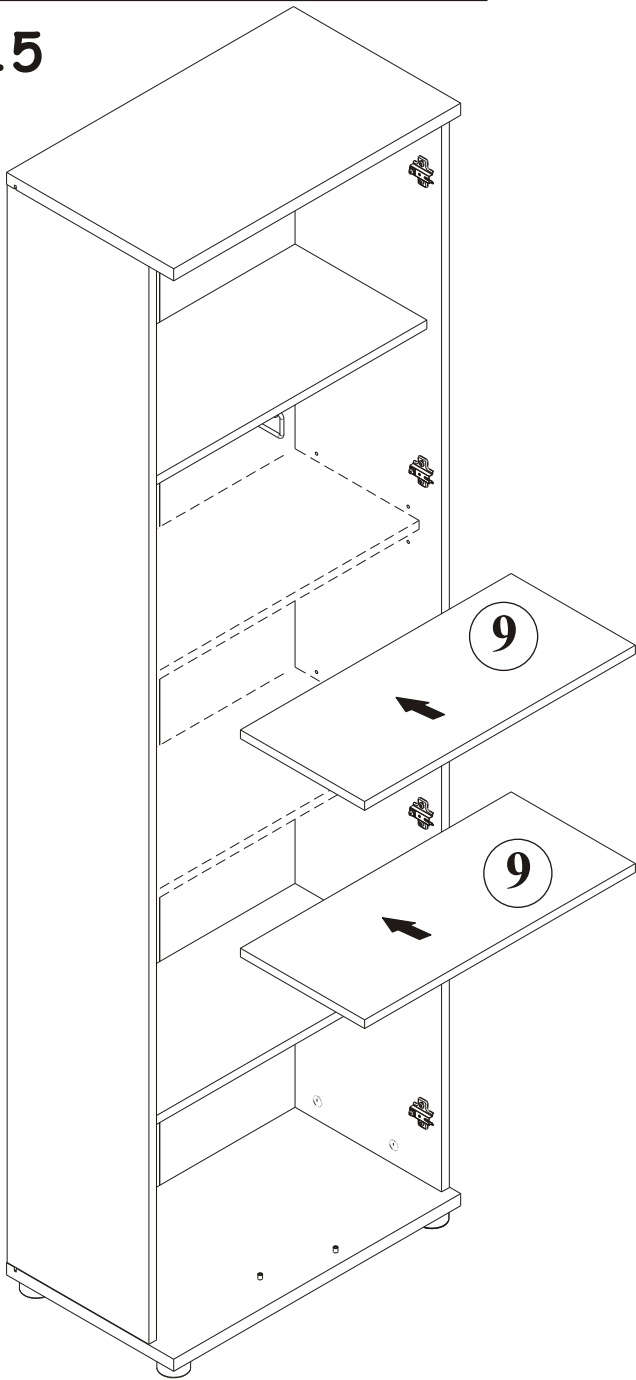

16

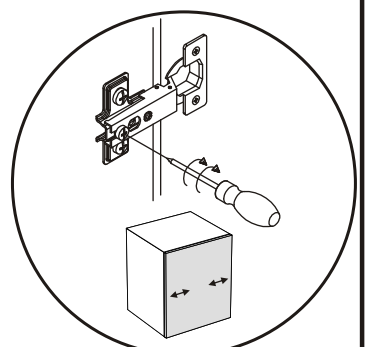
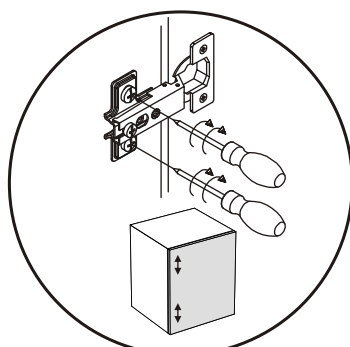
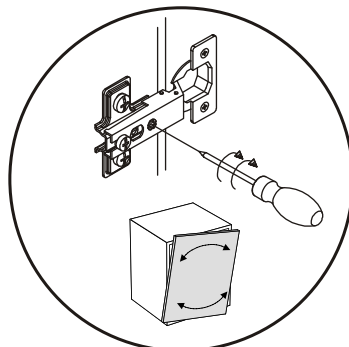
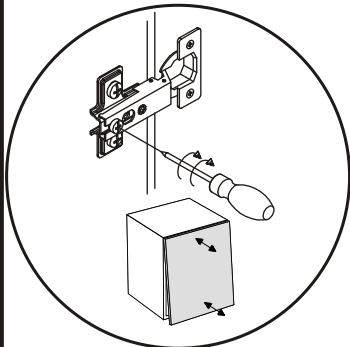
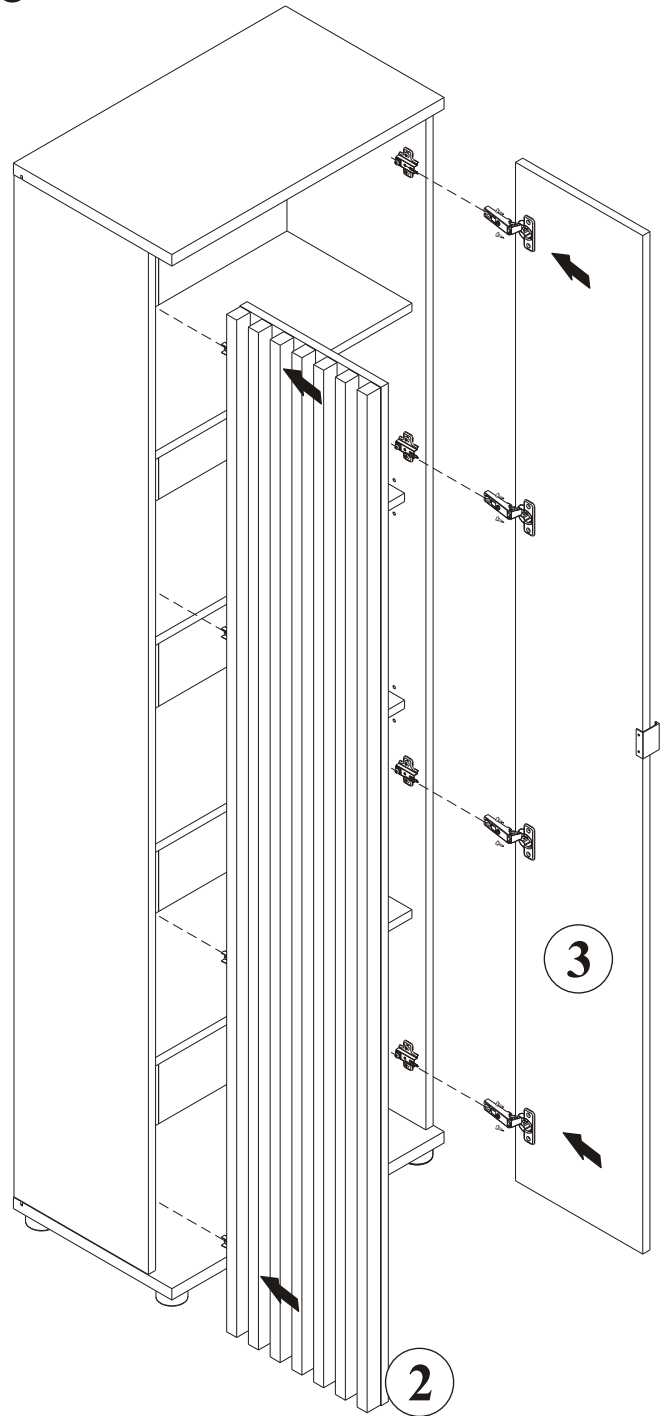



# ARMARIO / GUSTAVO / PEDRO TYP H

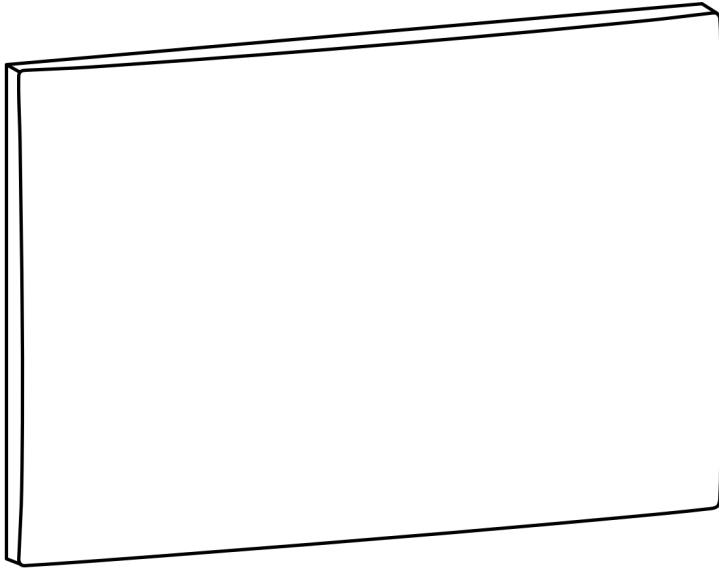

**3x**

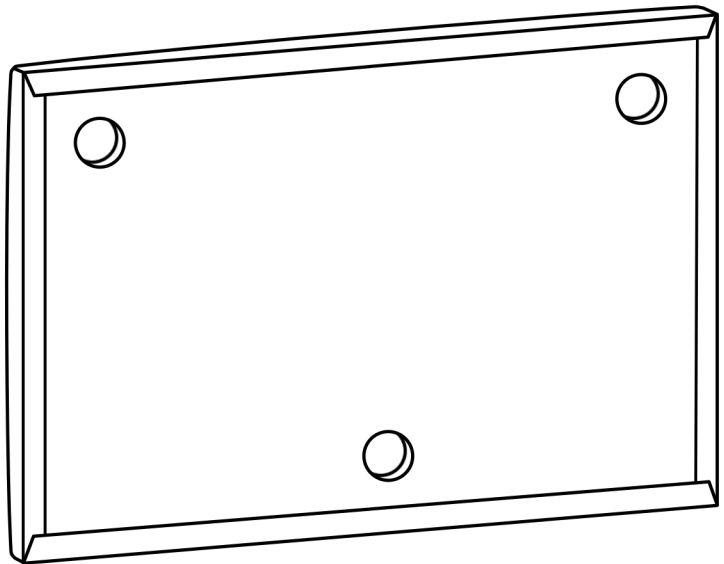

NO	Dim.		Col.-No	Qty
1	600	390	1	3

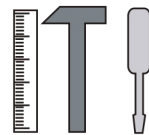
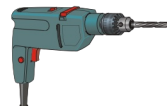

40 min

# AR / GV / PD TYP H

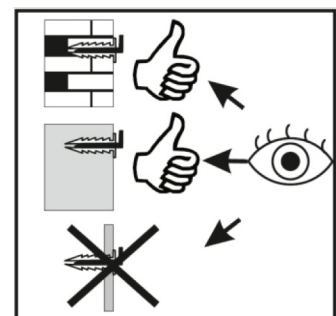
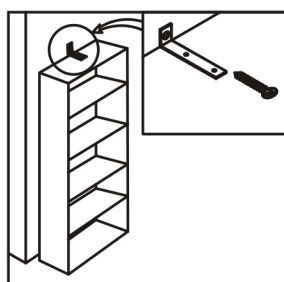
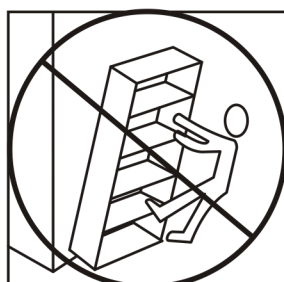
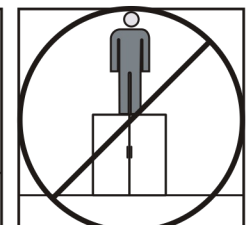
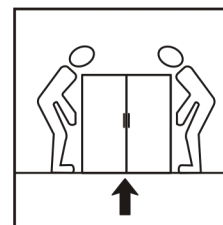
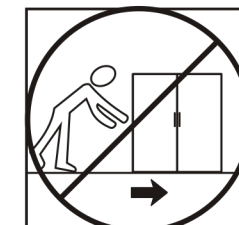
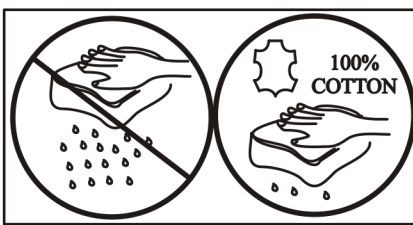
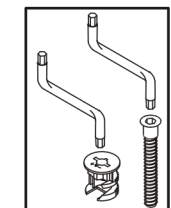
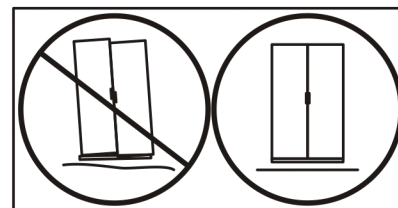
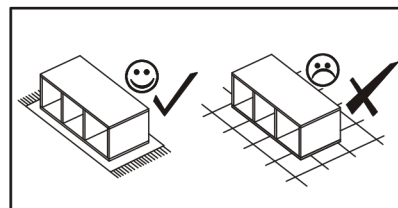
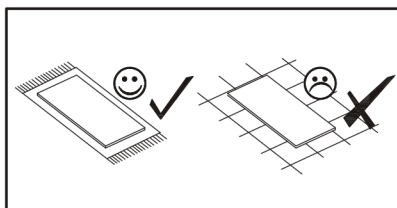
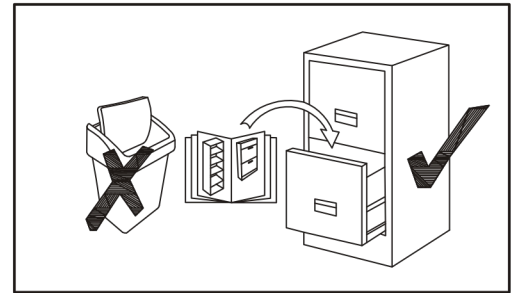
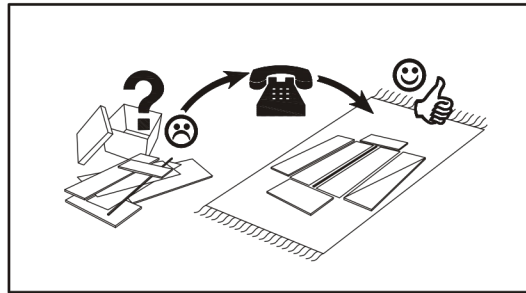
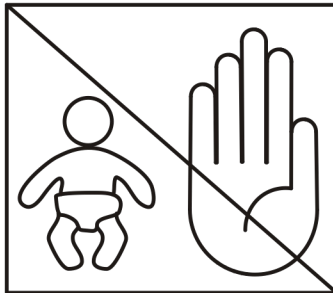
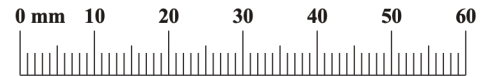
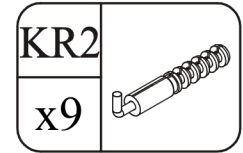
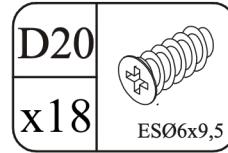
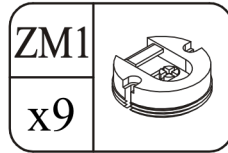

AR / GV / PD TYP H

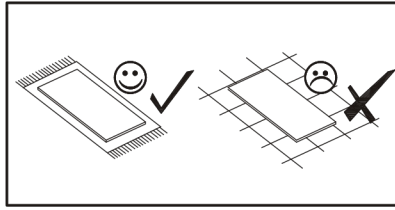

ZM1		D20	
x3		x6	ESØ6x9,5

3x

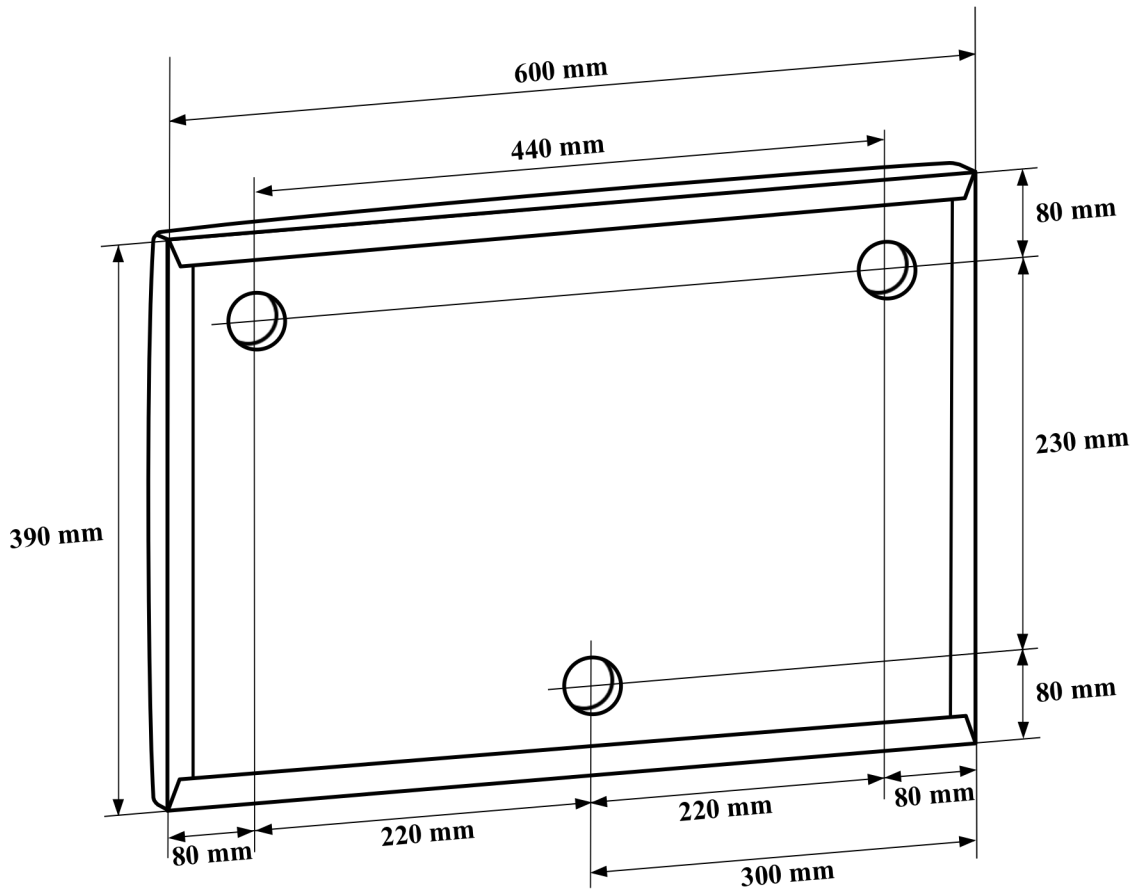
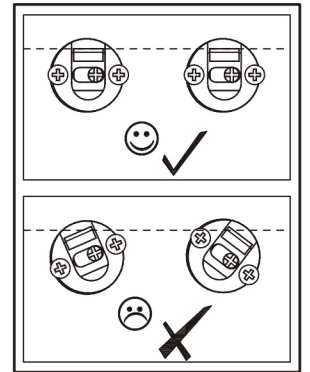
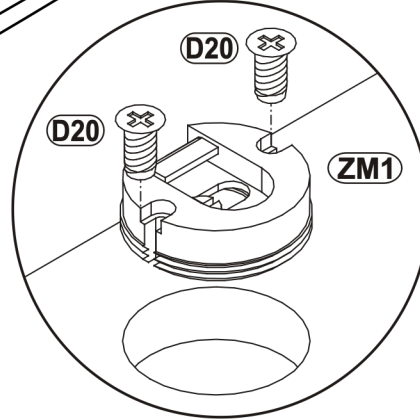
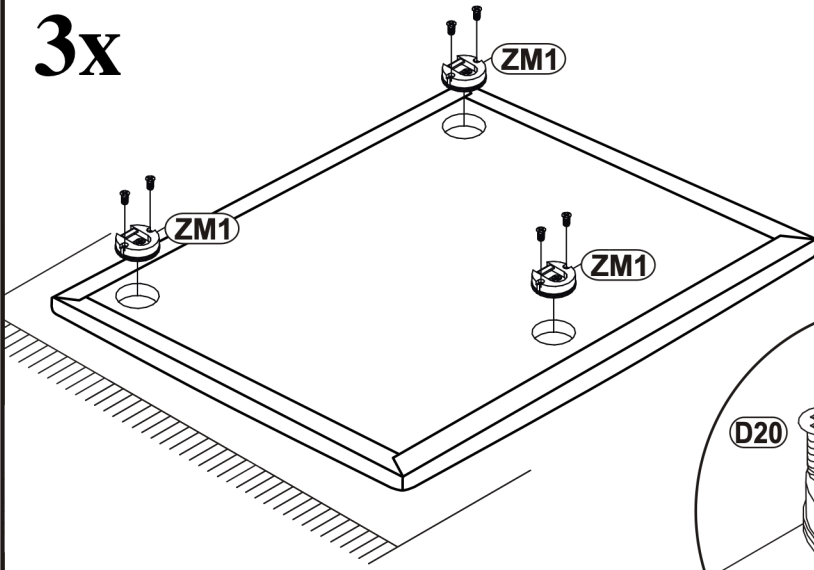

# AR / GV / PD TYP H

KR2  
x9

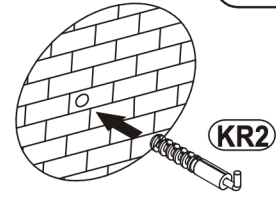
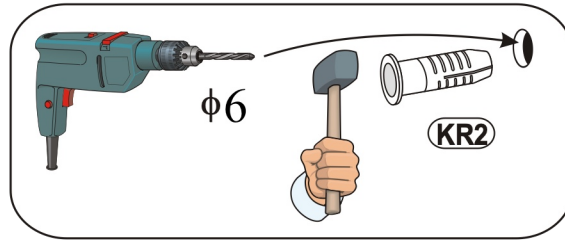
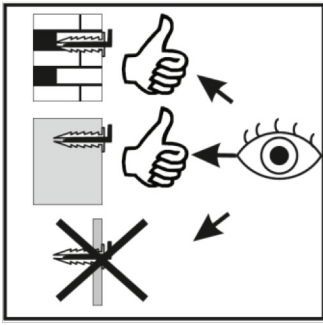
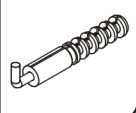

3x

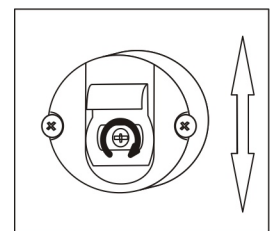
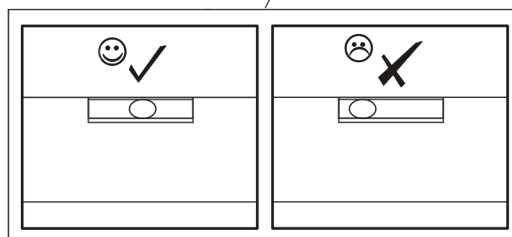
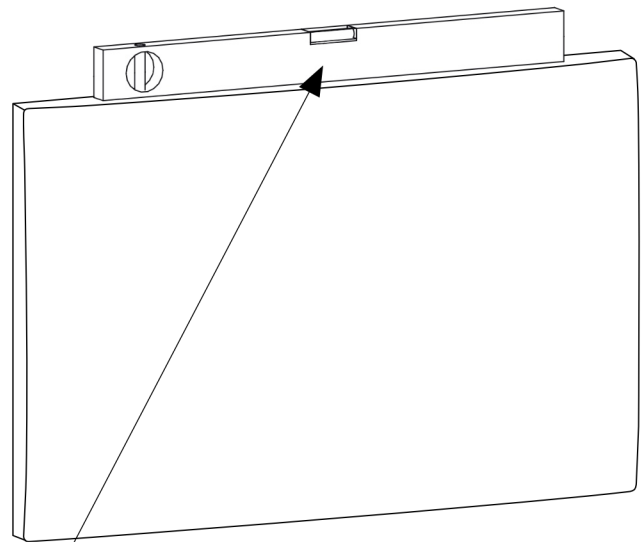
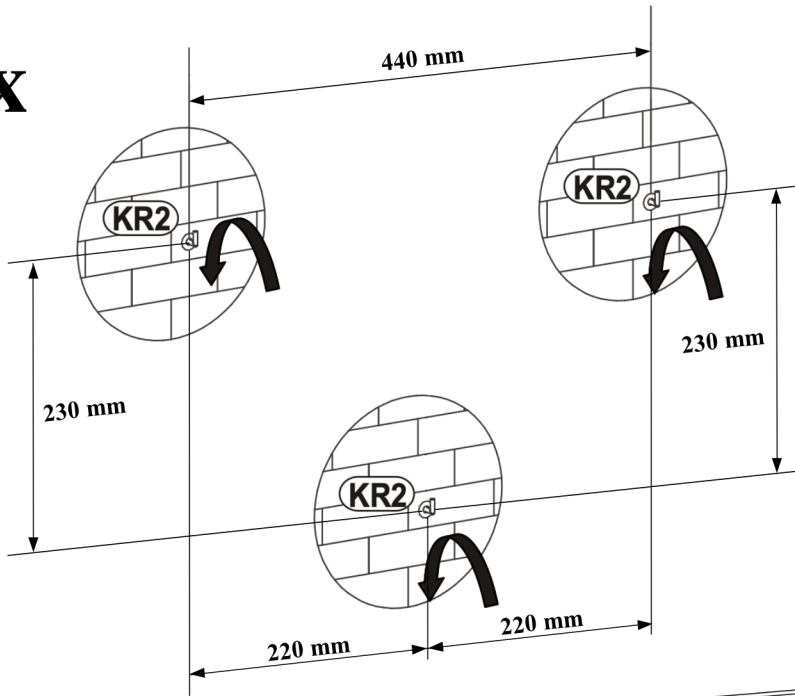

# PEDRO HJZ PD \_\_\_ TYP H

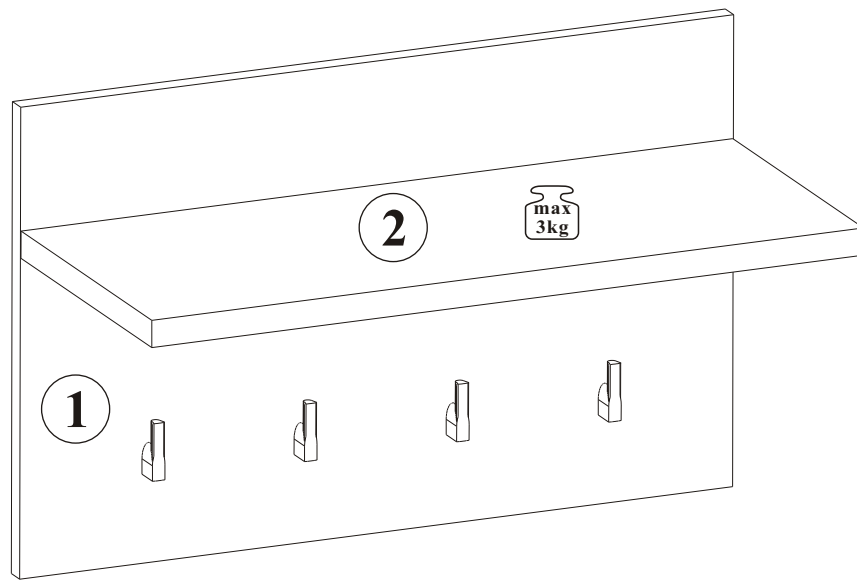
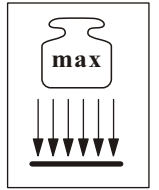

NO	DIM [mm]		COL.-NO	QTY
1	600	381	16	1/1
2	599	250	22	1/1

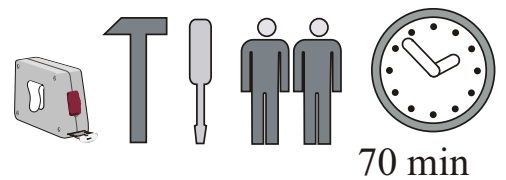



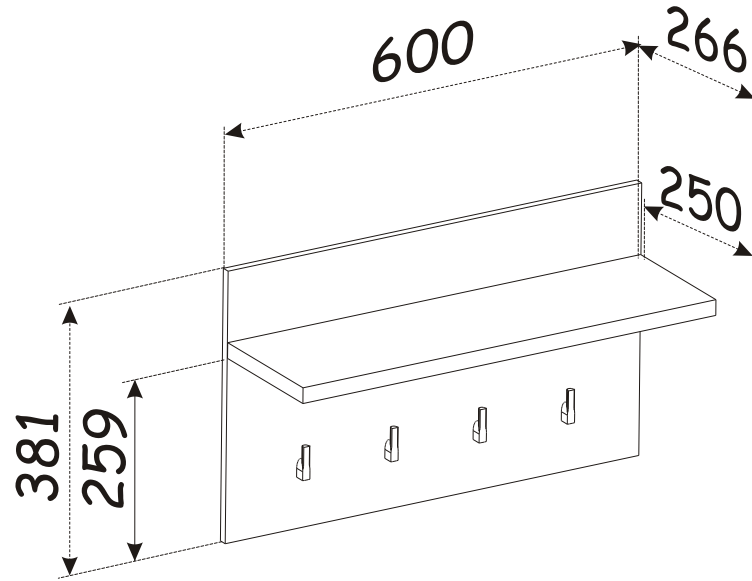

70 min

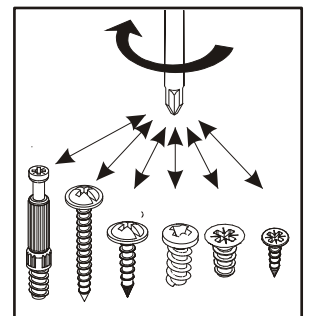
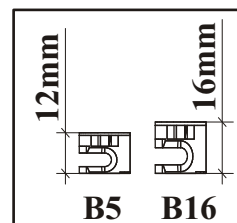
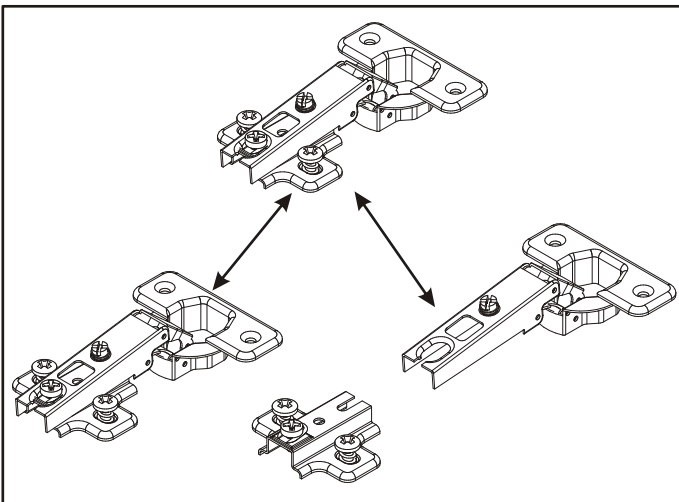
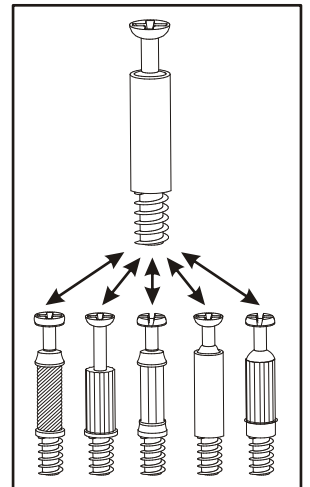
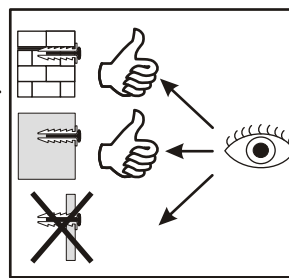
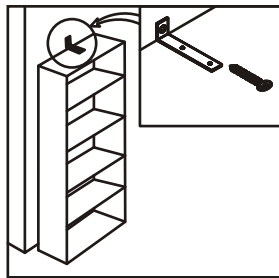
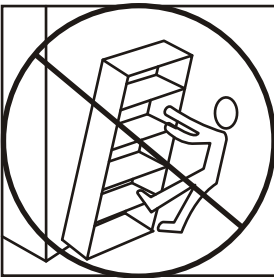
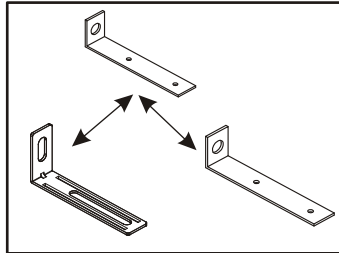
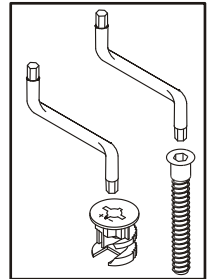
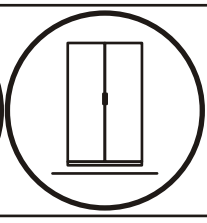
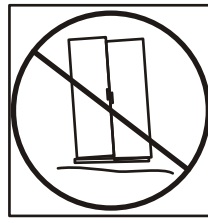
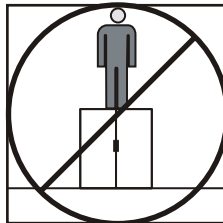
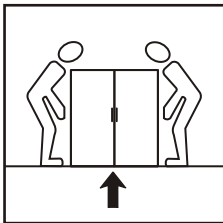
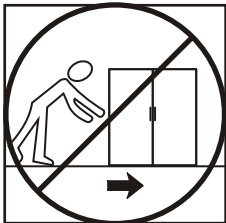
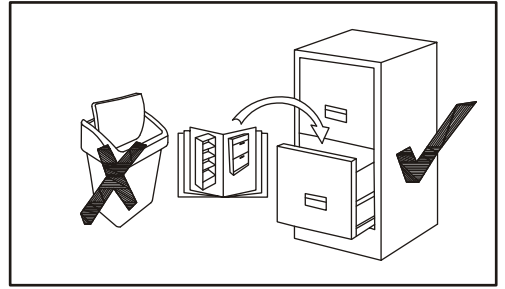
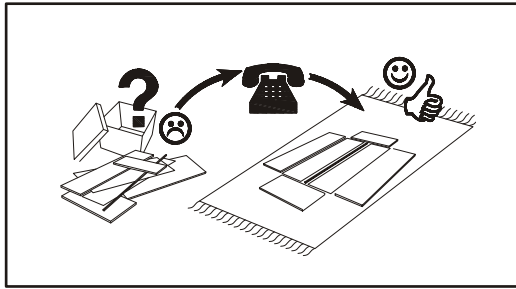
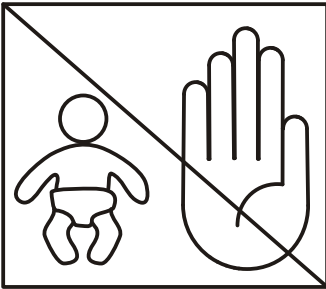
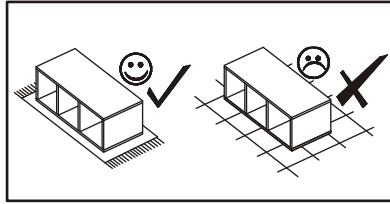
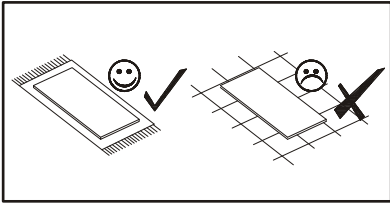
# PEDRO HJZ PD \_ TYP H



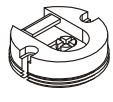
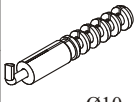
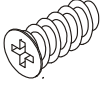
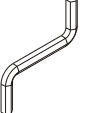
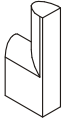

PEDRO HJZ PD \_ TYP H

B11 x5	 Ø7x50	G4 x5	 C	ZM1 x3		KR3 x3	 Ø10	D20 x6	 ESØ6,3x9,5	G2 x1	
WS1 x4		UP6 x8	 UPØ4x30								

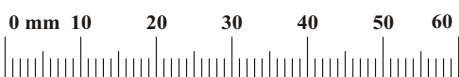



1

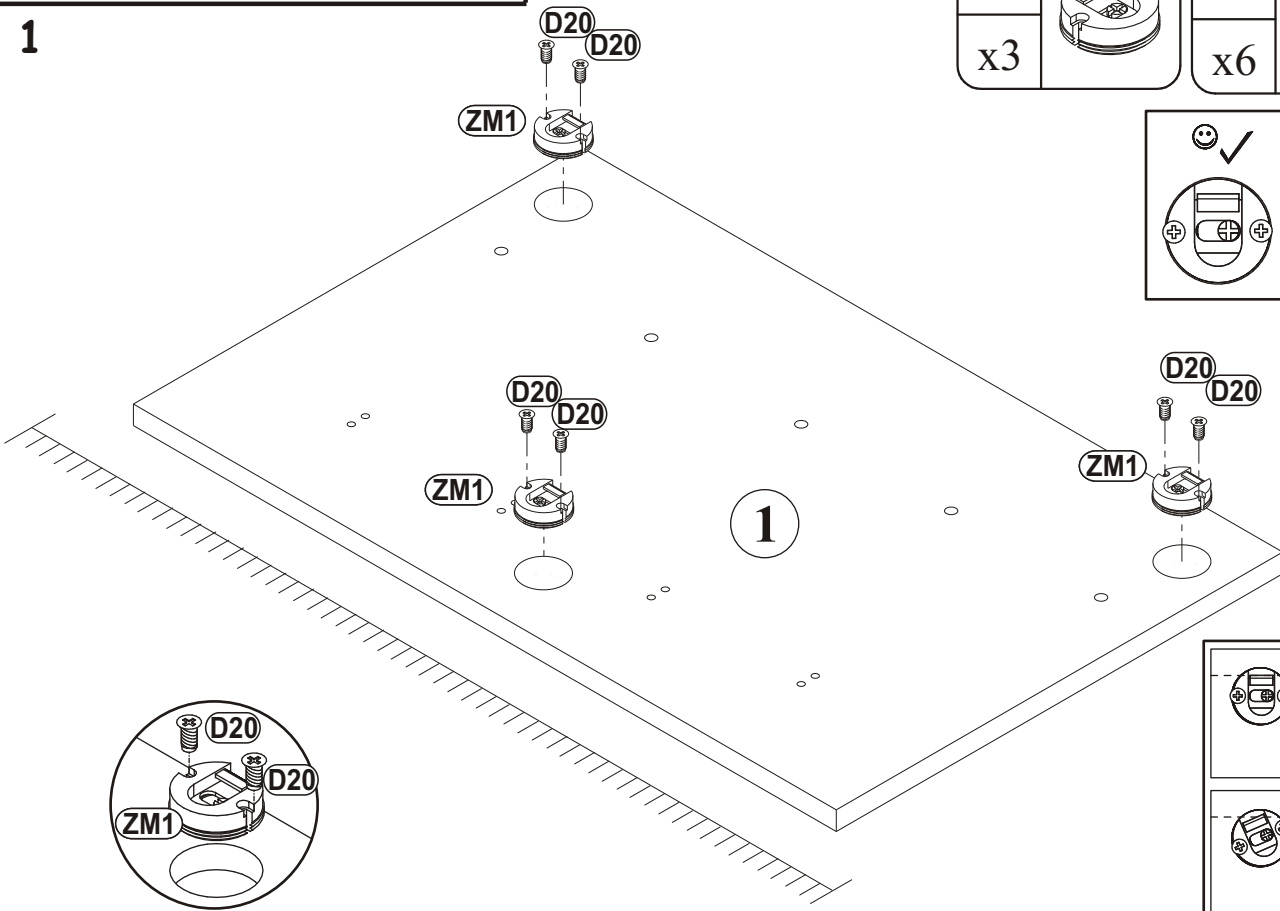

ZM1	
x3	

D20	
x6	ESØ6,3x9,5

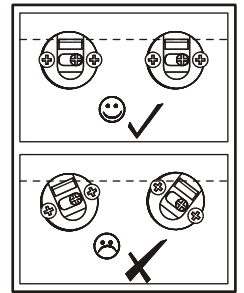
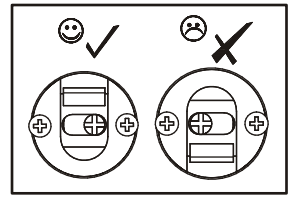

2

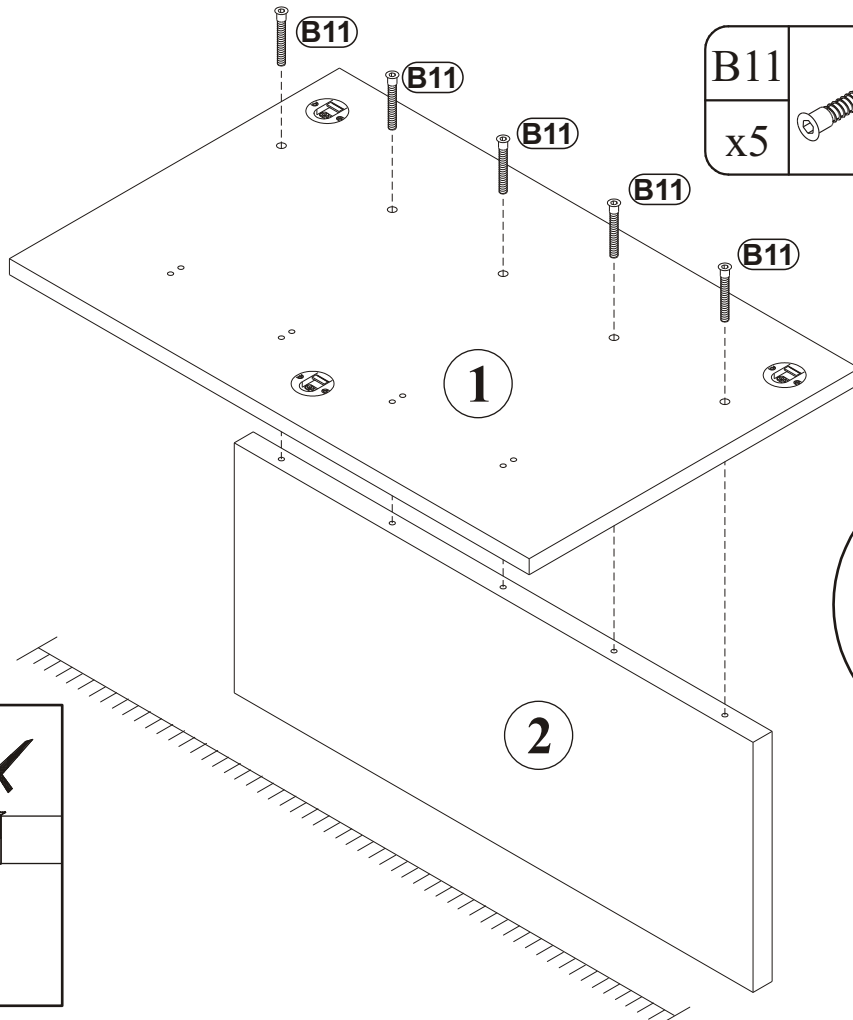

B11	
x5	Ø7x50

G4	
x5	C

G2	
x1	

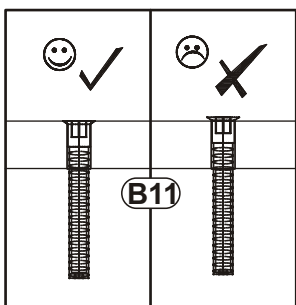
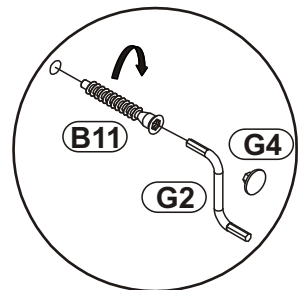

90°

90°

3

WS1		UP6	
x4		x8	UPØ4x30

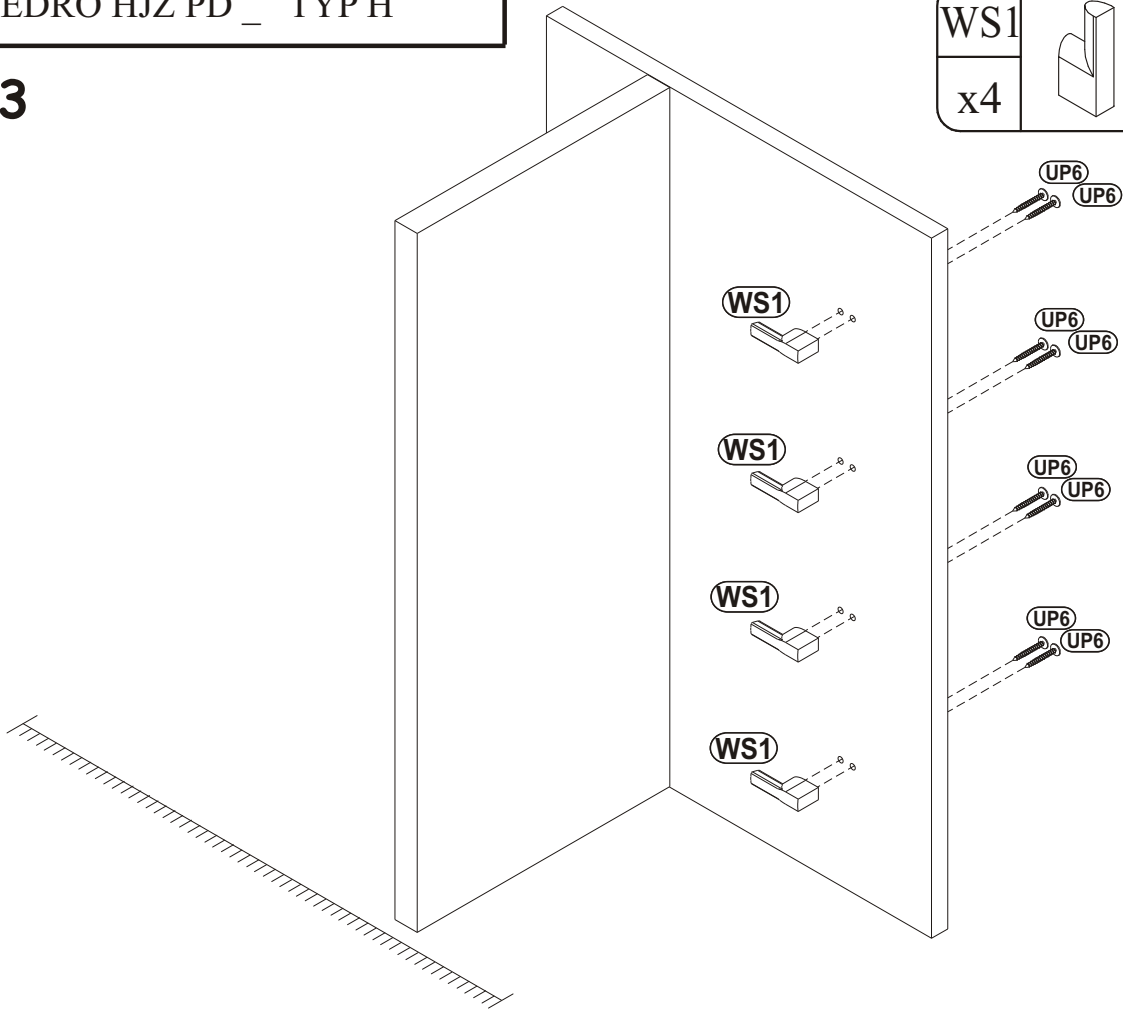

4

KR3	
x3	Ø10

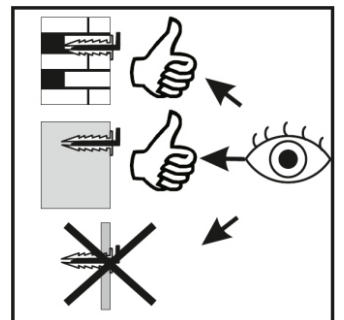
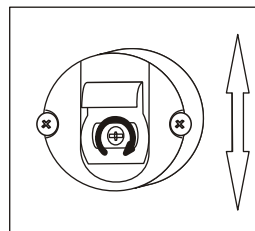
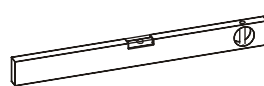
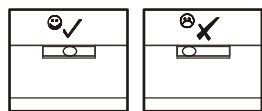
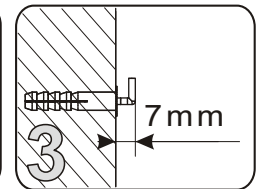
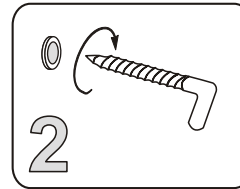
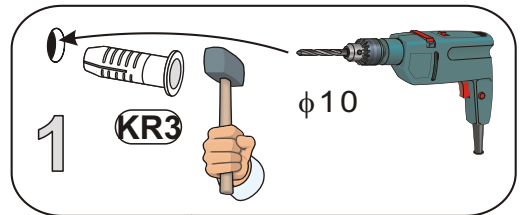
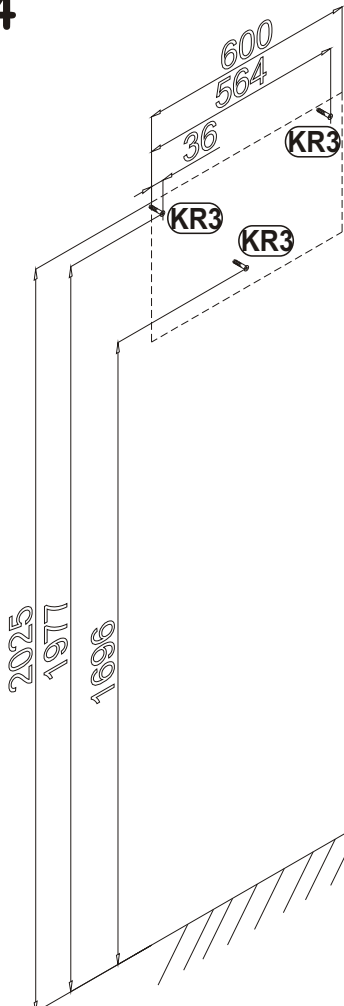

# PEDRO HJZ PD \_\_\_ TYP F

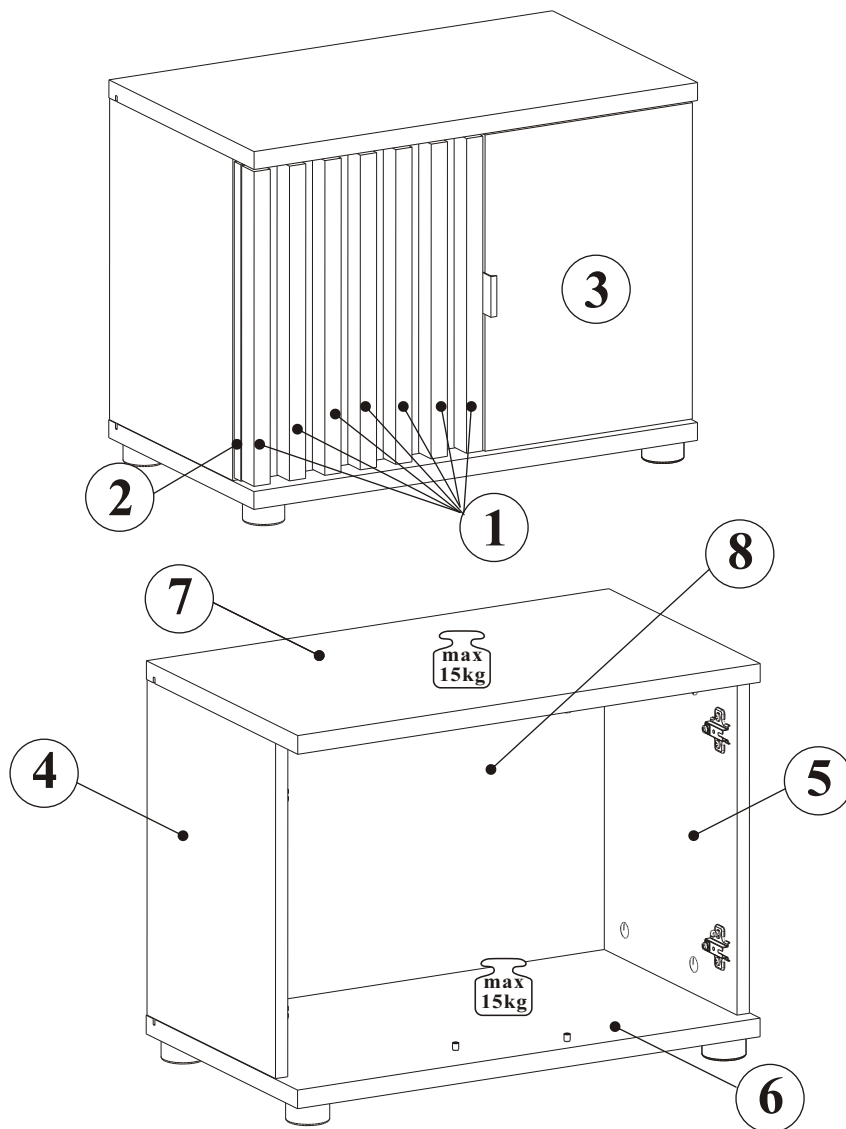
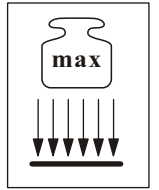

NO	DIM [mm]		COL.-NO	QTY
1	387	30	22 1/1	7
2	312	389	16 1/1	1
3	281	389	16 1/1	1
4	396	297	16 1/1	1
5	396	327	16 1/1	1
6	601	350	22 1/1	1
7	601	350	22 1/1	1
8	408	579	3 1/1	1

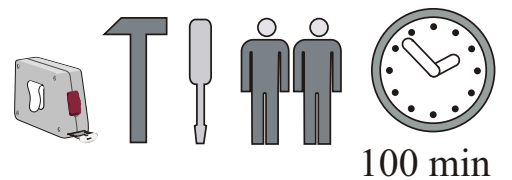



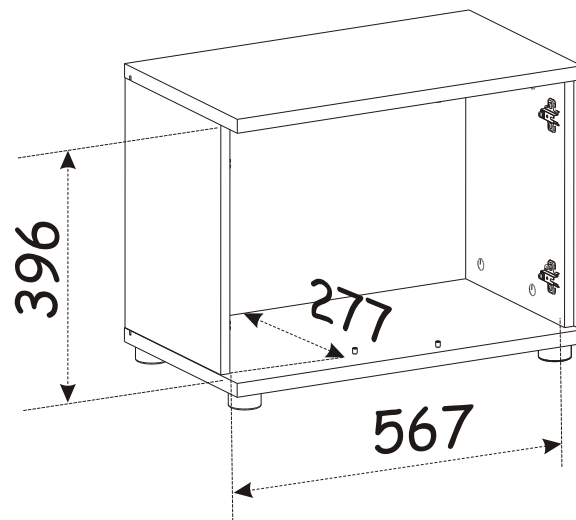
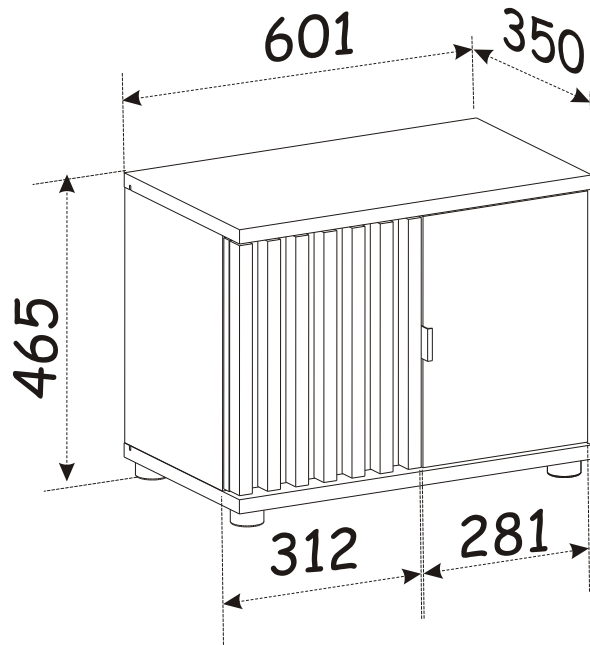

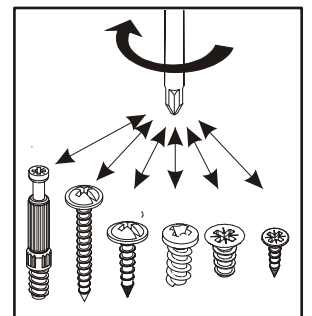
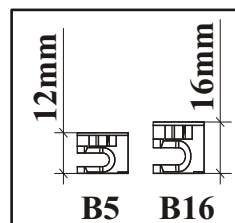
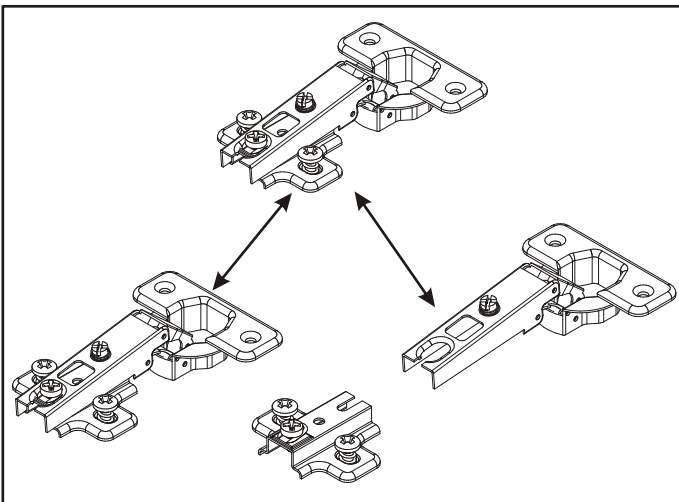
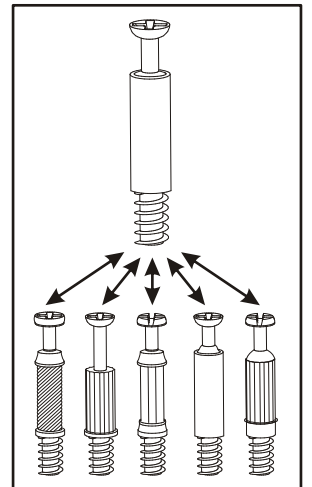
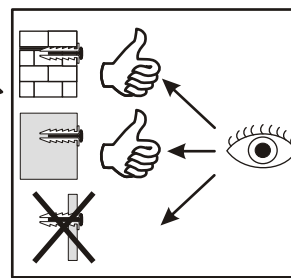
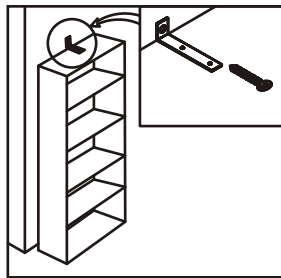
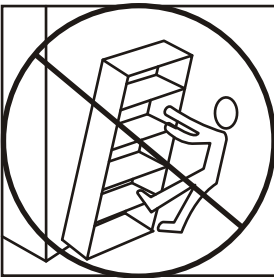
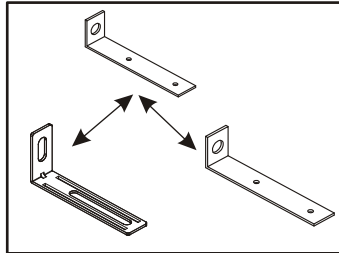
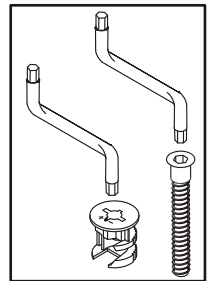
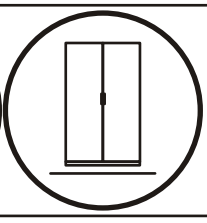
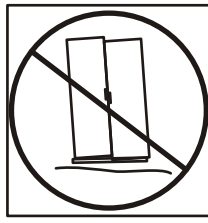
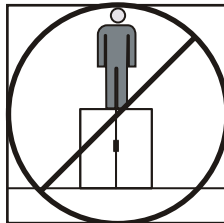
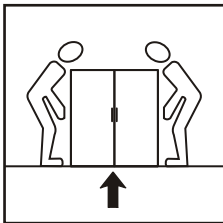
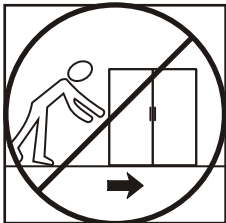
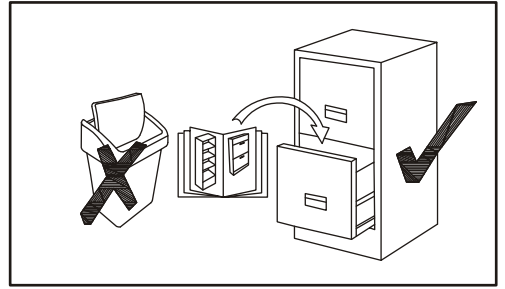
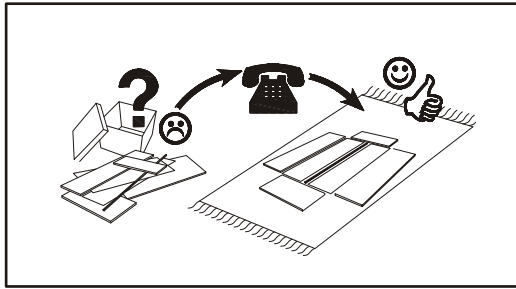
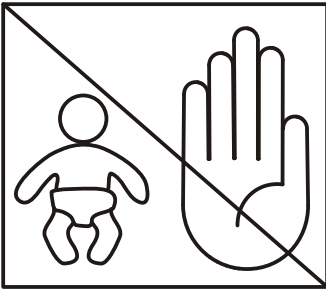
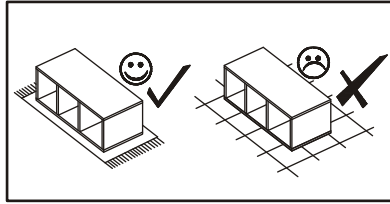
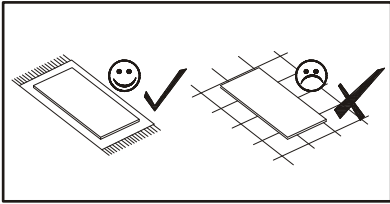

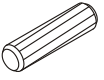

# PEDRO HJZ PD \_ TYP F

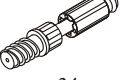

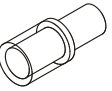
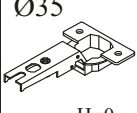
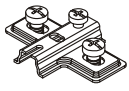
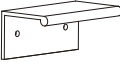
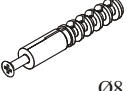
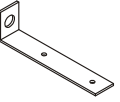
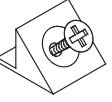
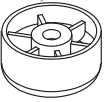

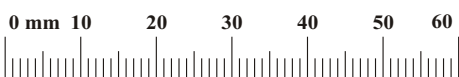

PEDRO HJZ PD \_ TYP F

A1 x8  ø8x36	B22 x21  Ø7x40	G4 x18 	B4 x8  34	B5 x8  ø15x12	G5 x8 
G20 x4 	E21 x4  Ø35 H=0	E2 x4  H=0	G02 x1  L-32mm.	KR1 x2  Ø8	L1 x2 
S1 x6 	ST7 x4  Ø50, h=25	UP17 x4  UPØ4x25	D10 x14  USØ3,5x13	G2 x1 	G12 x3  Ø14

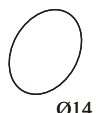

1

G12	
x3	Ø14

B22	
x21	Ø7x40

G4	
x18	

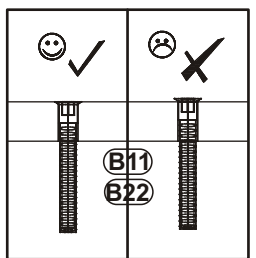
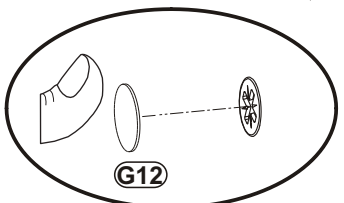
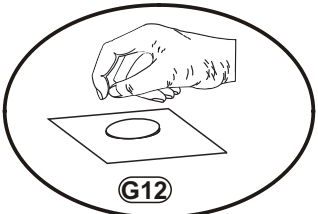
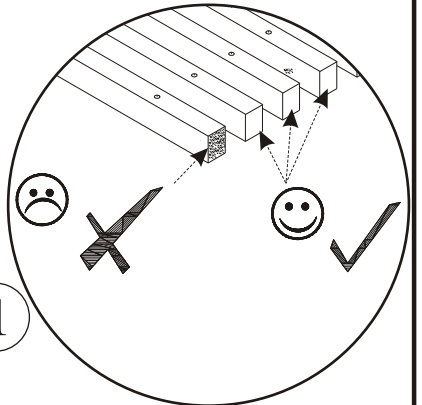
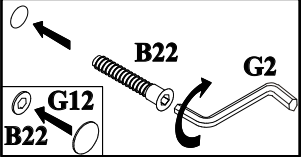
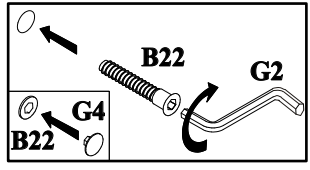
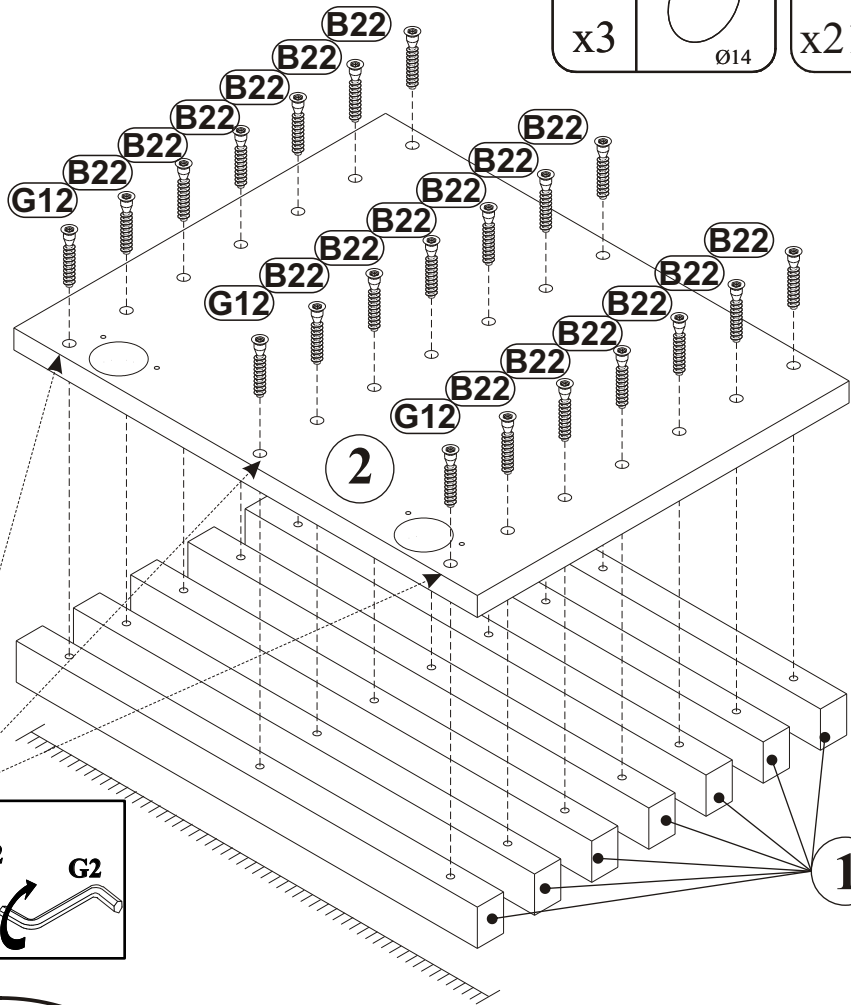

2

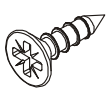
D10	
x4	USØ3,5x13

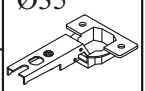
E21	
x2	Ø35 H=0

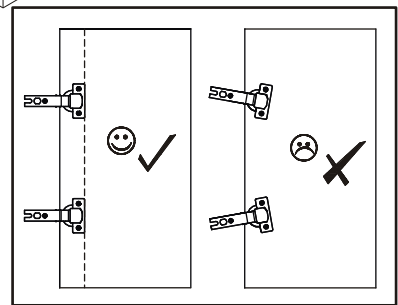
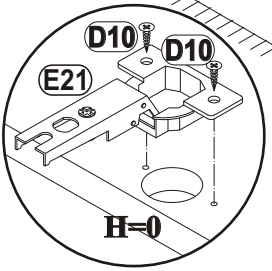
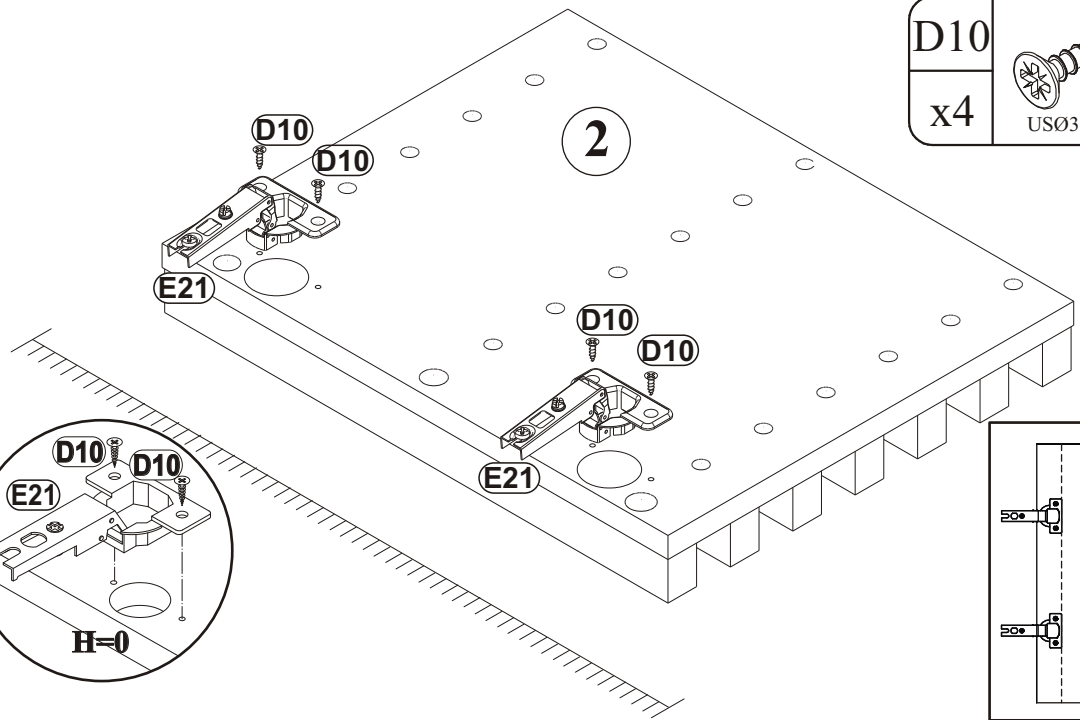

3

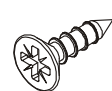
D10	
x6	USØ3,5x13

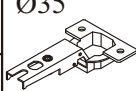
E21	Ø35 
x2	H=0

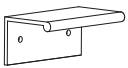
G02	
x1	L-32mm.

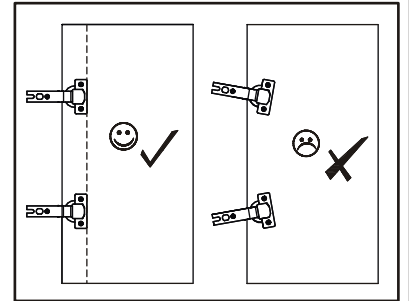
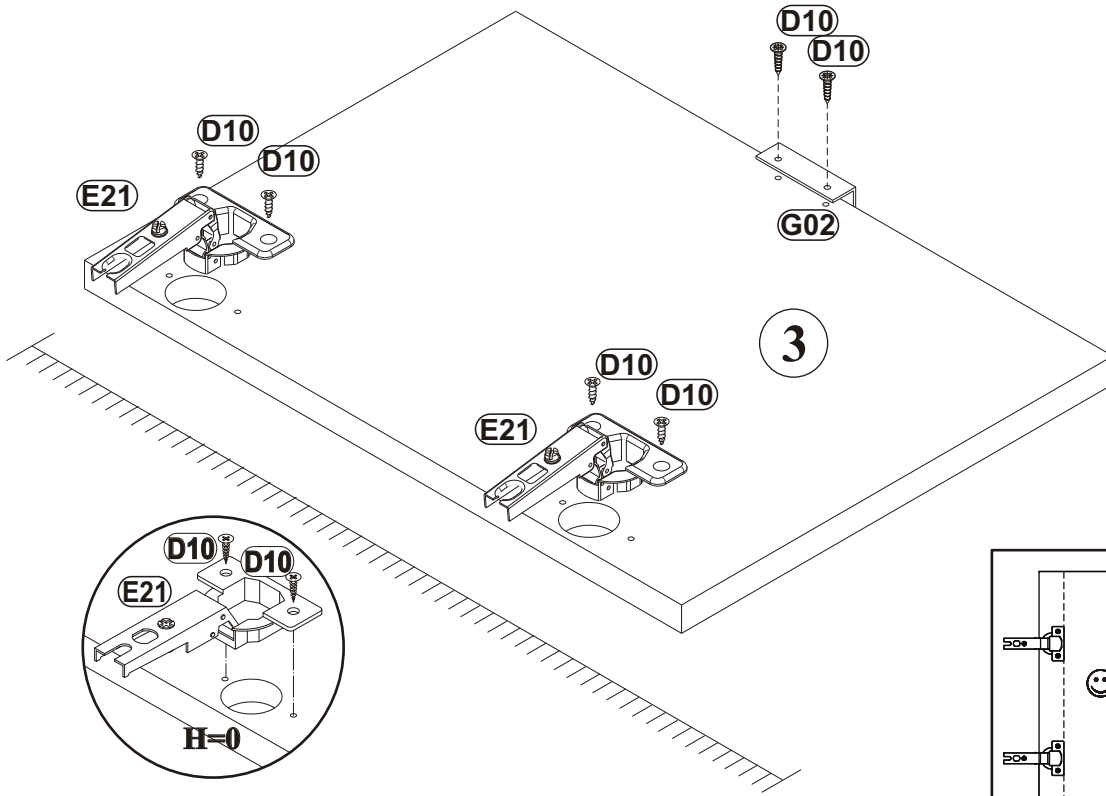

4

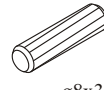
A1	
x4	ø8x36

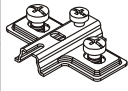
E2	
x2	H=0

B5	
x4	ø15x12

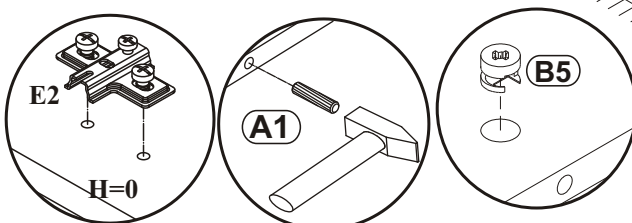
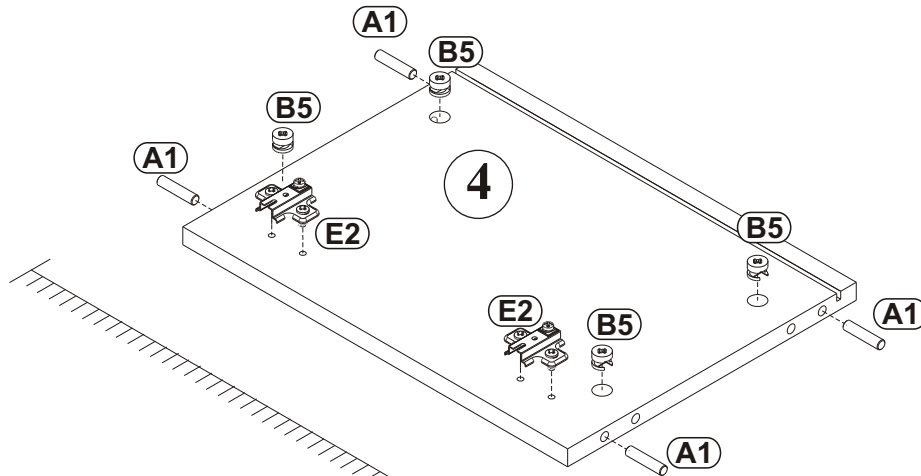

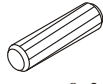

5

A1	
x4	ø8x36

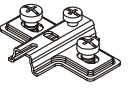
E2	
x2	H=0

B5	
x4	ø15x12

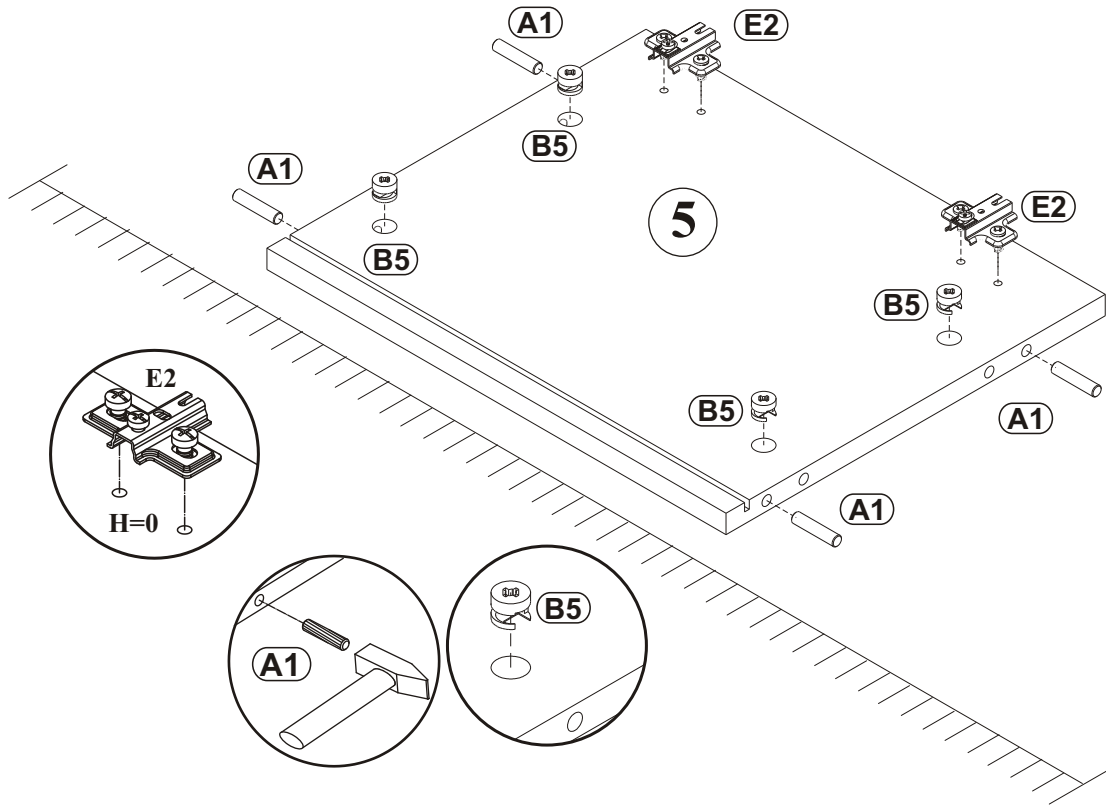

6

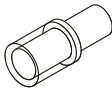
G20	
x2	

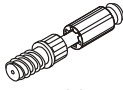
B4	
x4	34

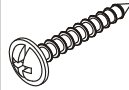
UP17	
x4	UPØ4x25

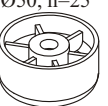
ST7	Ø50, h=25
x4	

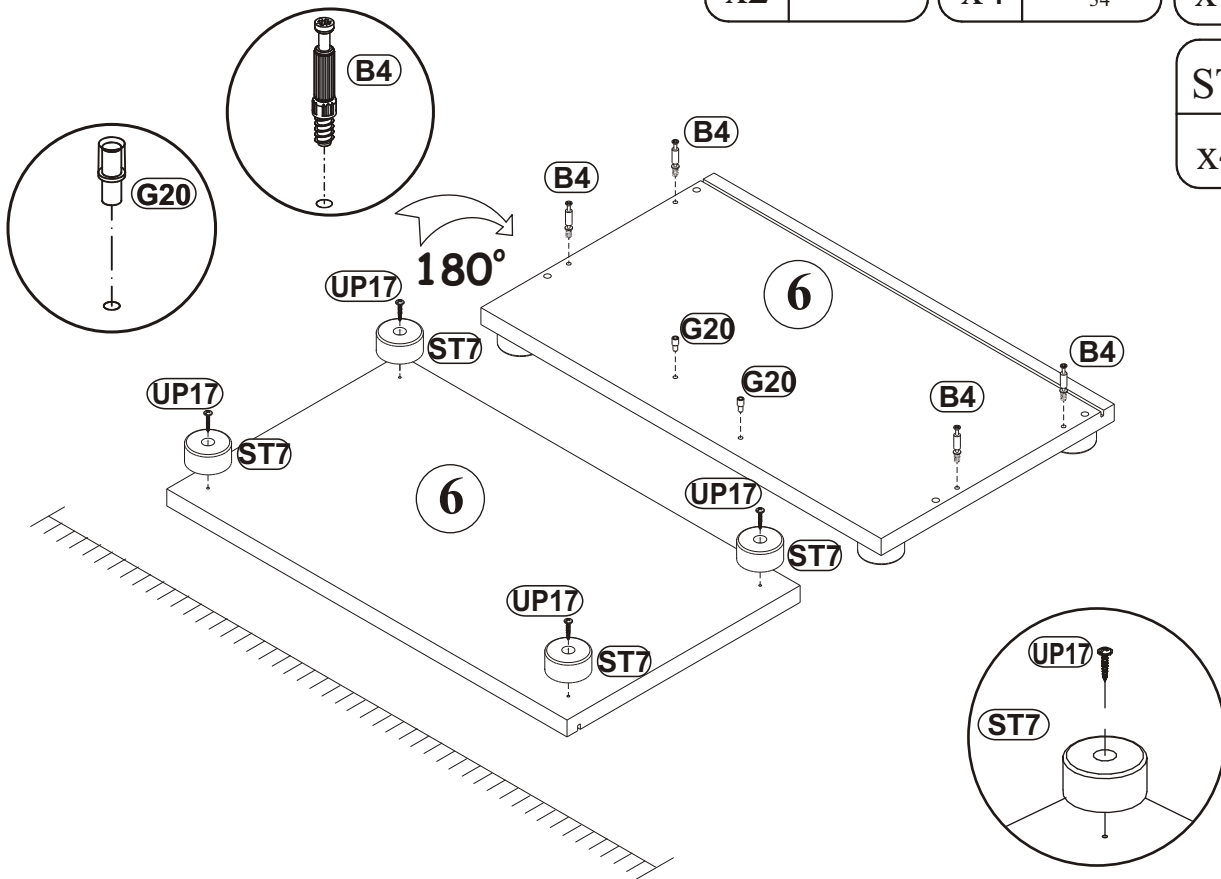

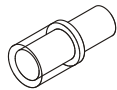
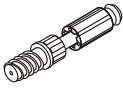
G20		B4	
x2		x4	34

7

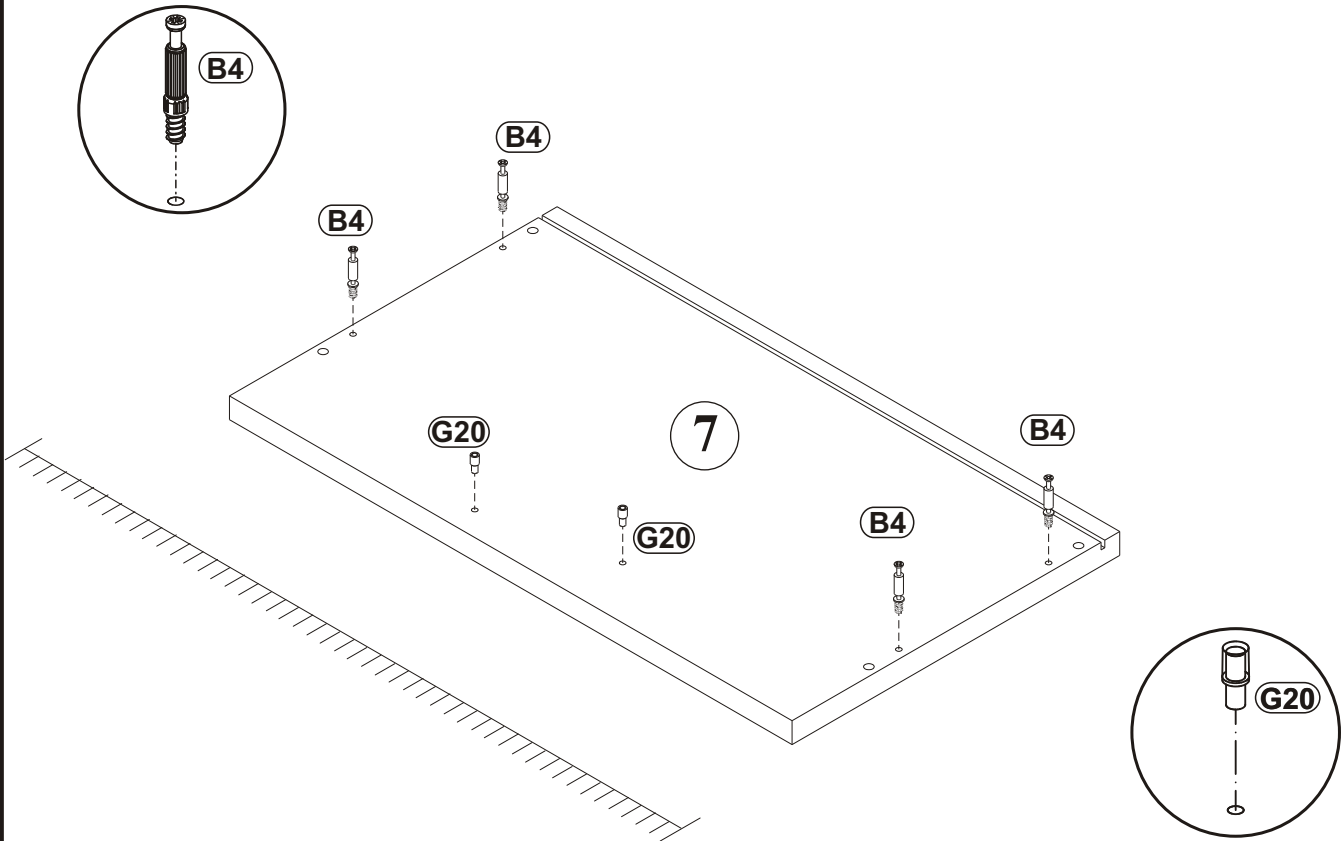

8

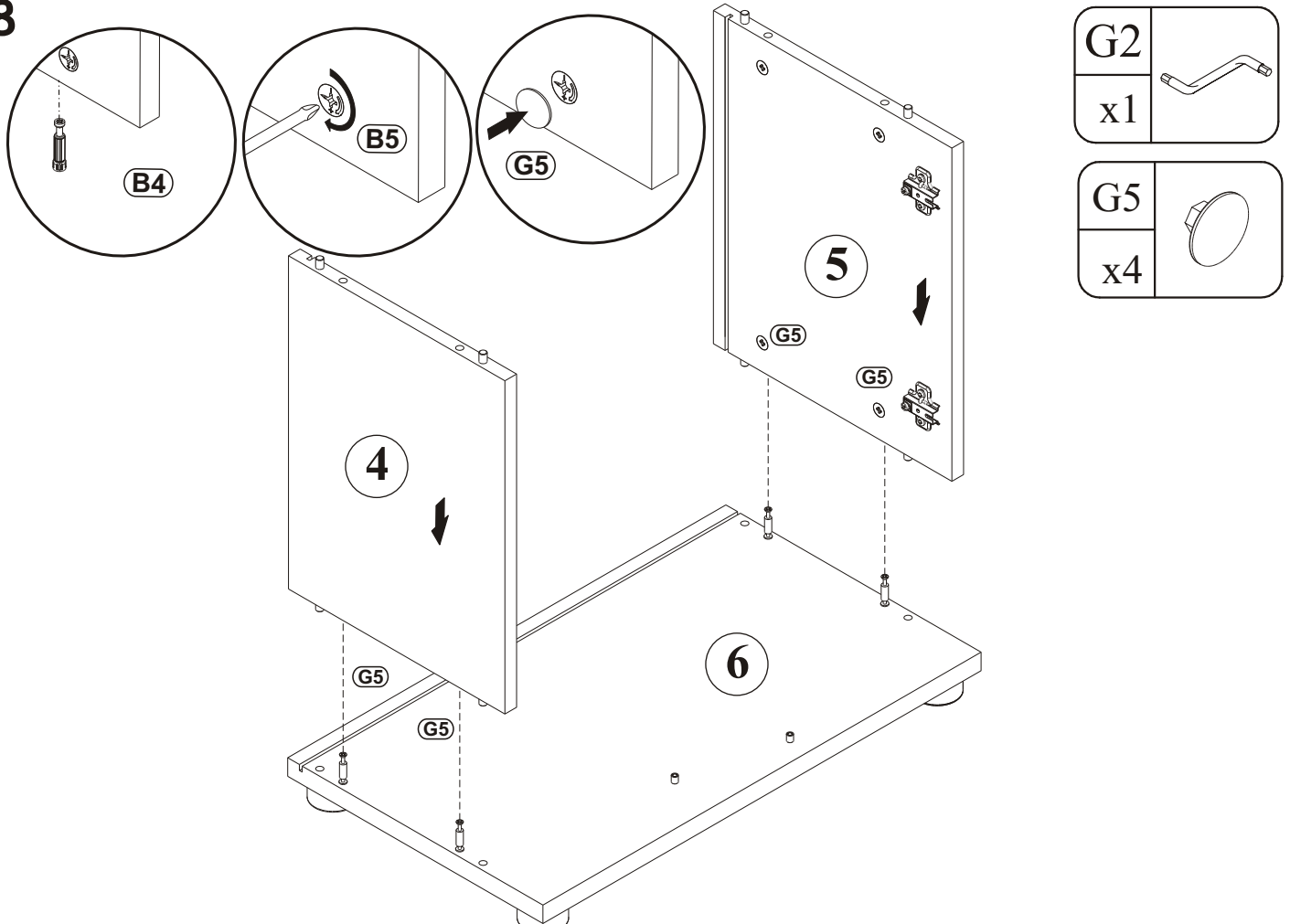

9

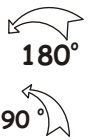
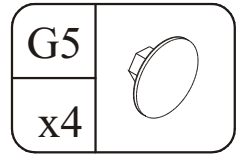
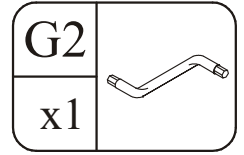
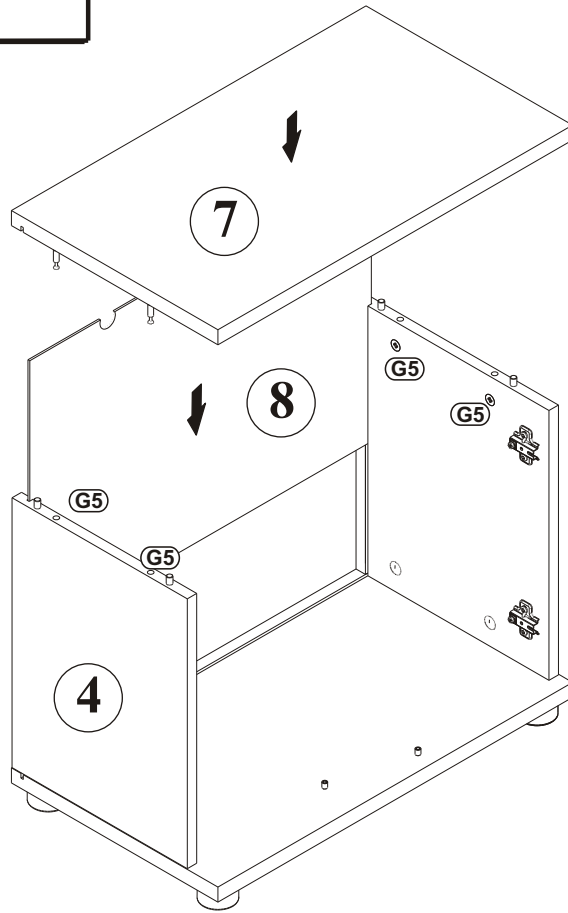
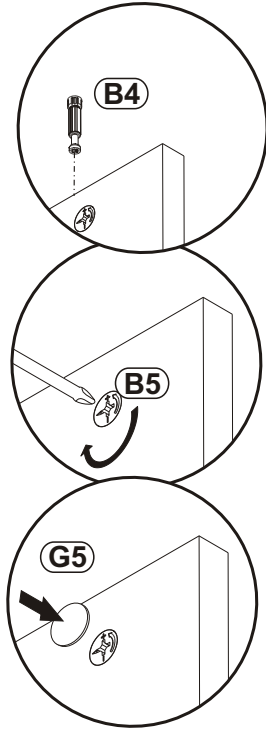

10

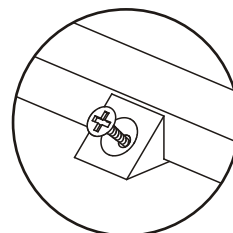
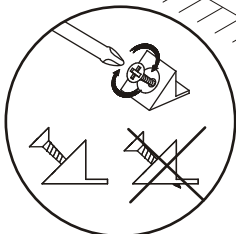
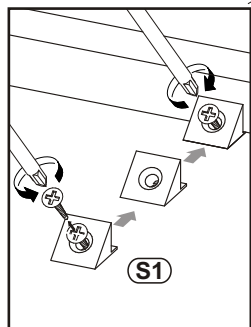
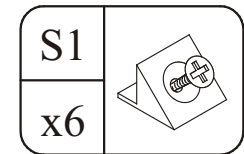
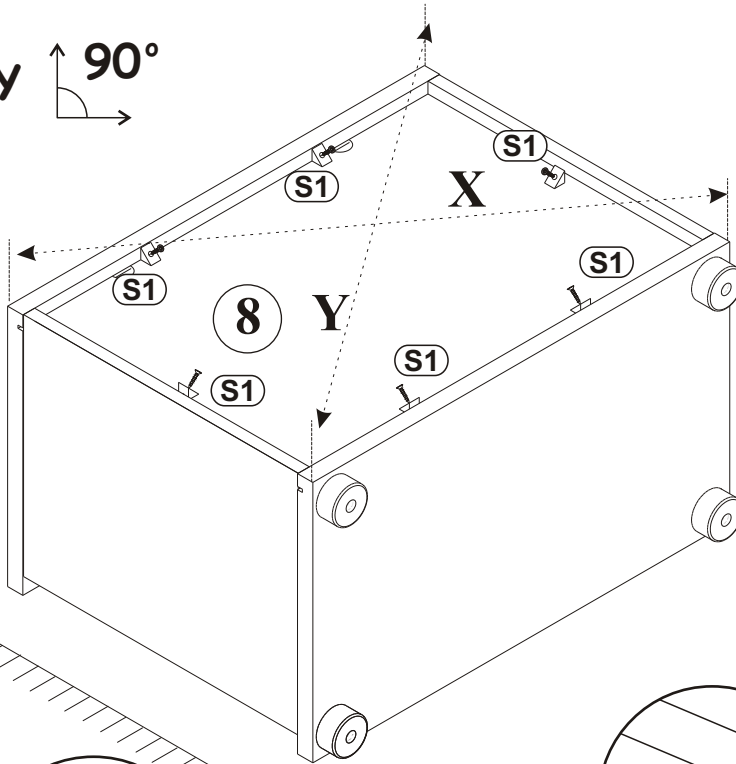

11

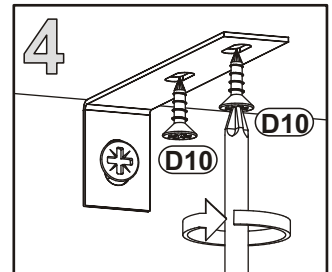
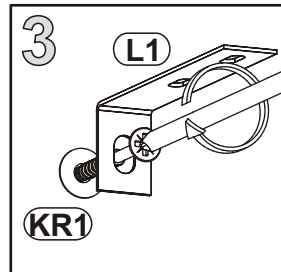
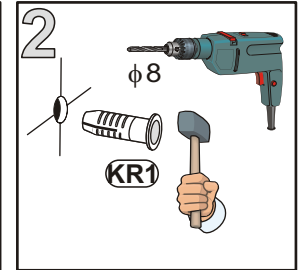
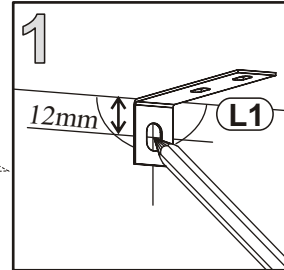
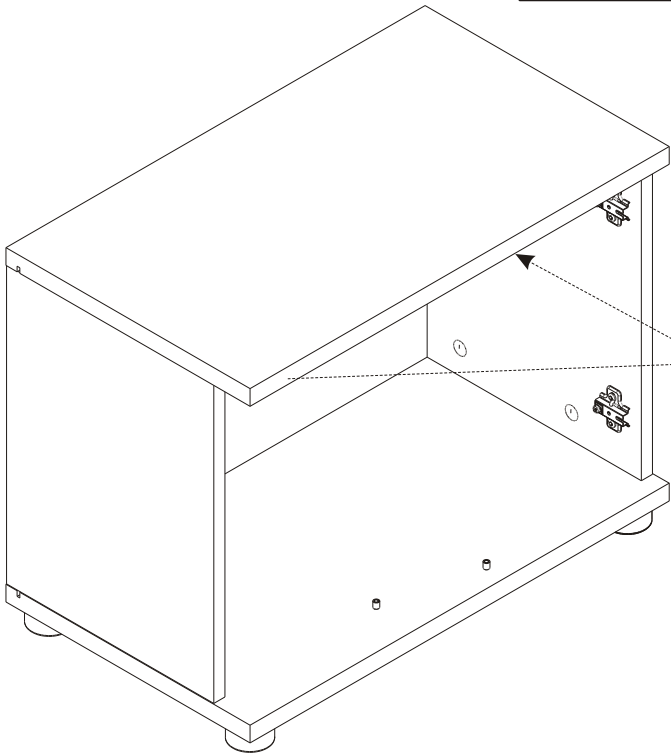
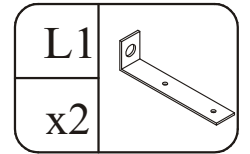
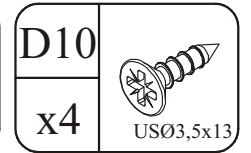
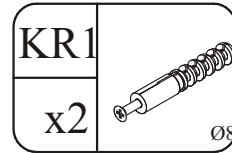
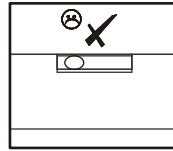
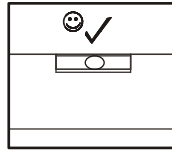

12

