

SWITCH SW3

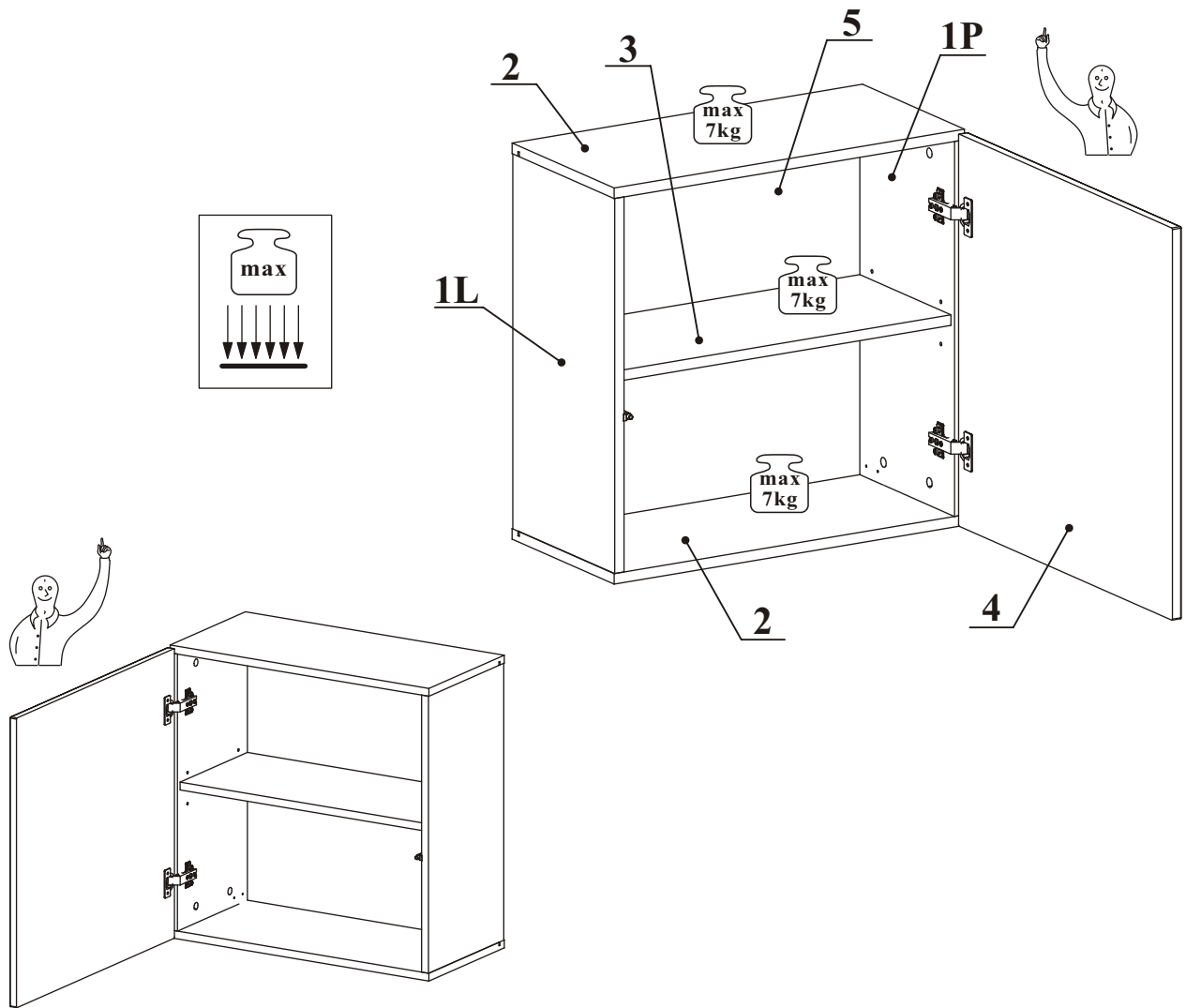

NO	Dim.		Col.-No	Qty
1 L/P	570	284	1	2
2	602	284	1	2
3	568	254	1	1
5	582	580	1	1
4	596	596	1	1

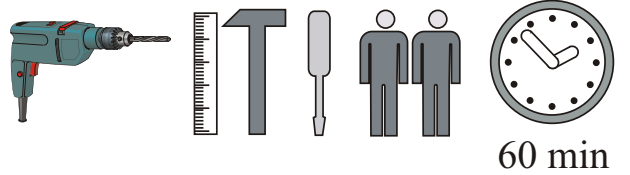

60 min

SWITCH - SW3

A1 X8 ø8x36	B4 X8	G5 X8	B5 X8 ø15x12	G7 X4	S1 X8
Z2 X4 ø5	D10 X6 USØ3,5x13	G2 X1	E1 X2 Ø26 H=0	E2 X2 H=0	ZR1 X2
D6 X4 USØ3,5x30	OD1 X1	KR2 X2			

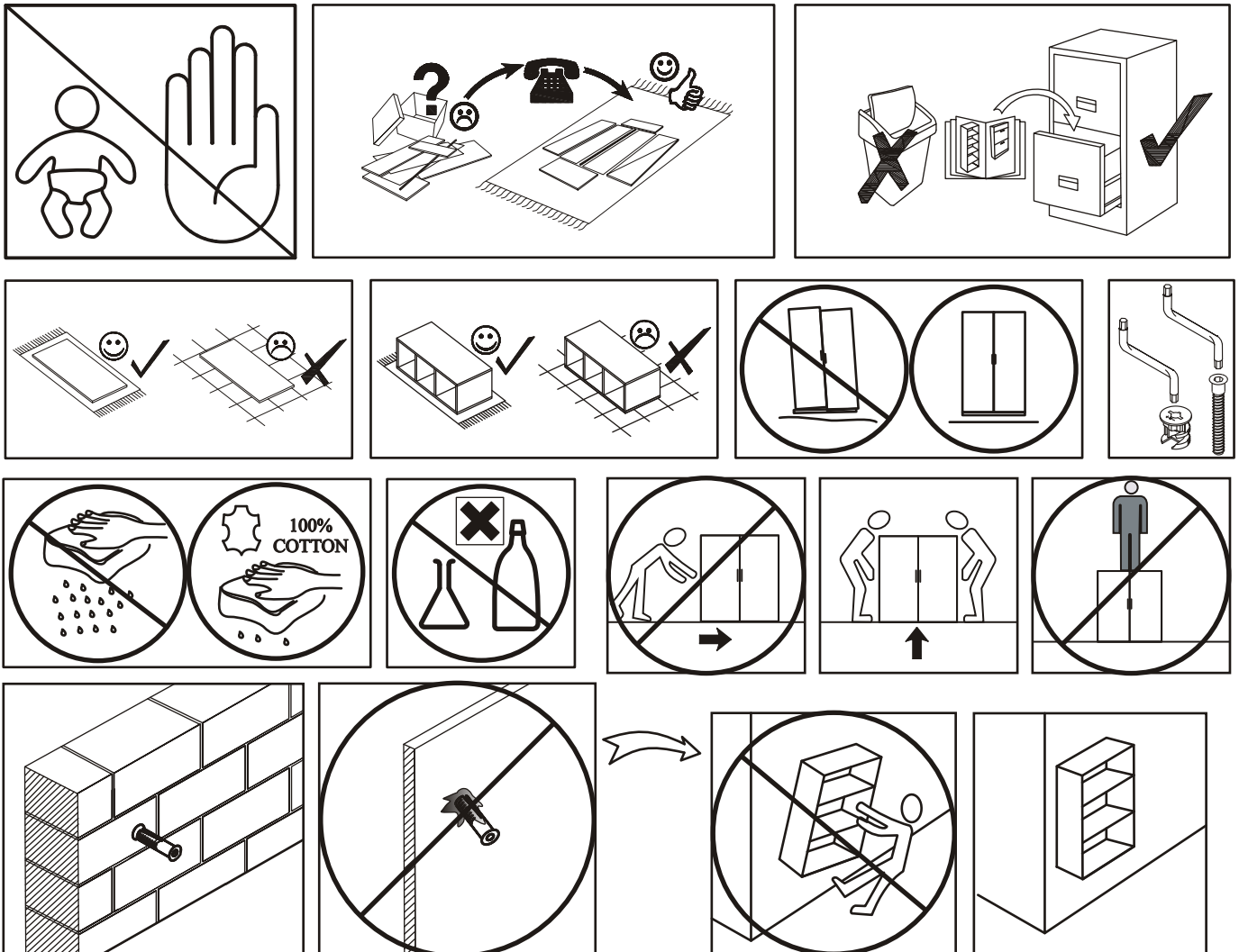
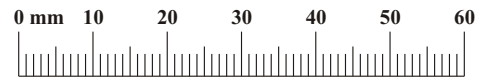

SWITCH - SW3

1

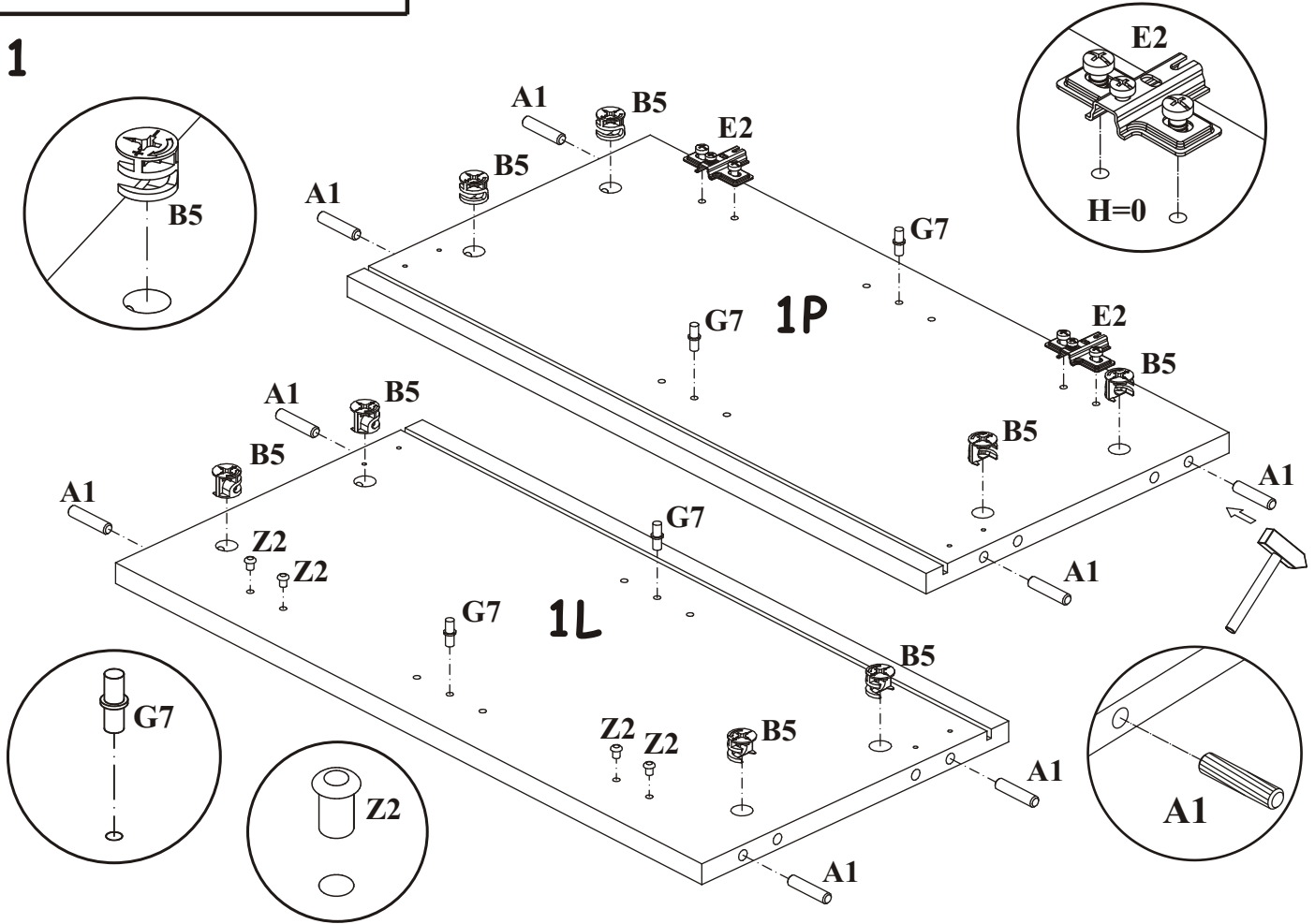

2

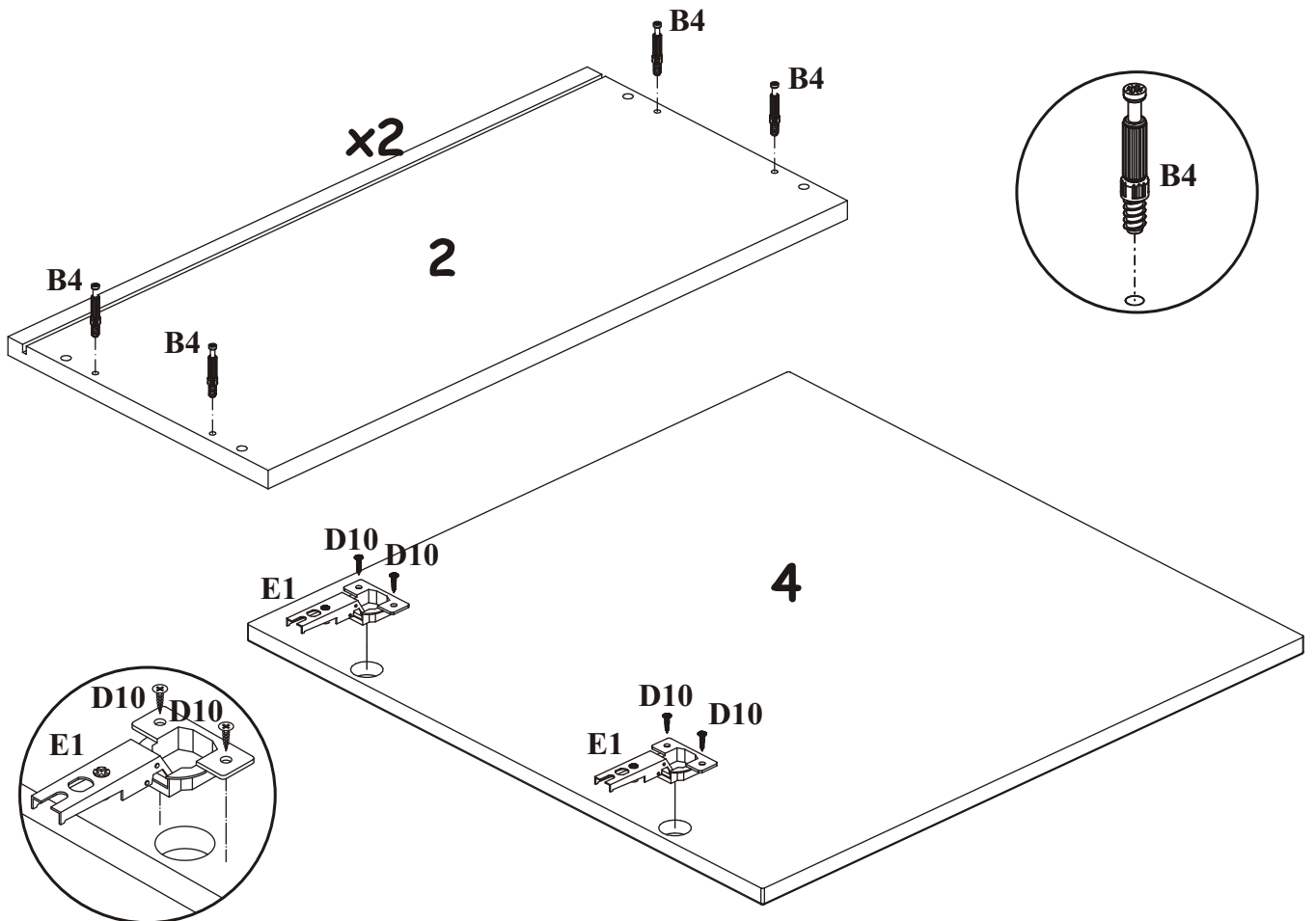

SWITCH - SW3

3

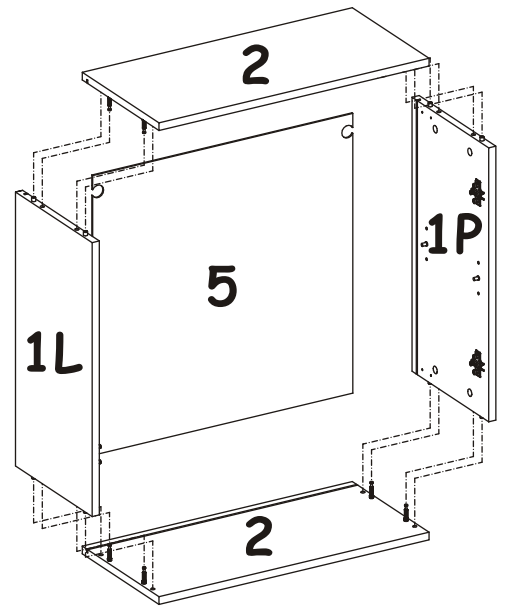
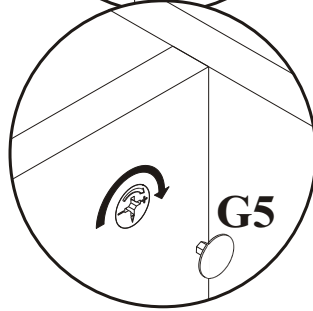
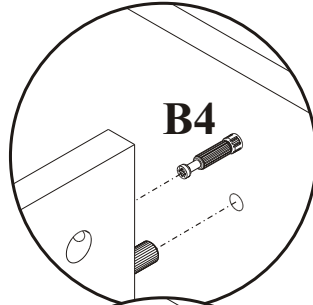
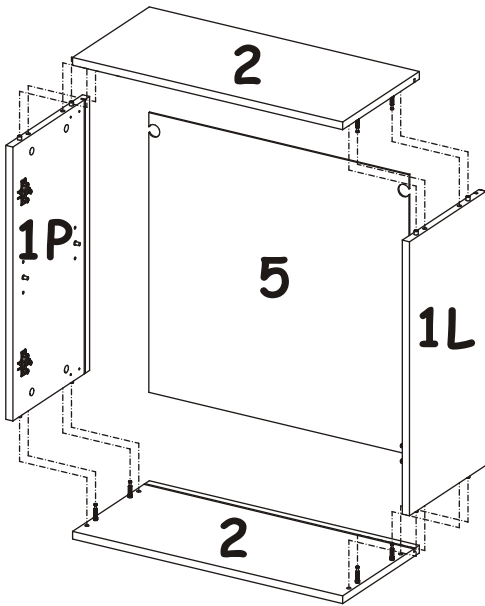
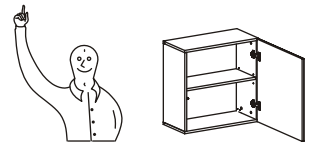
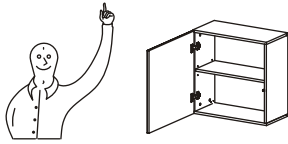

4

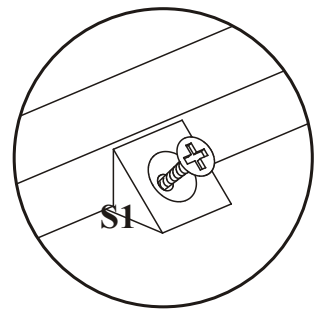
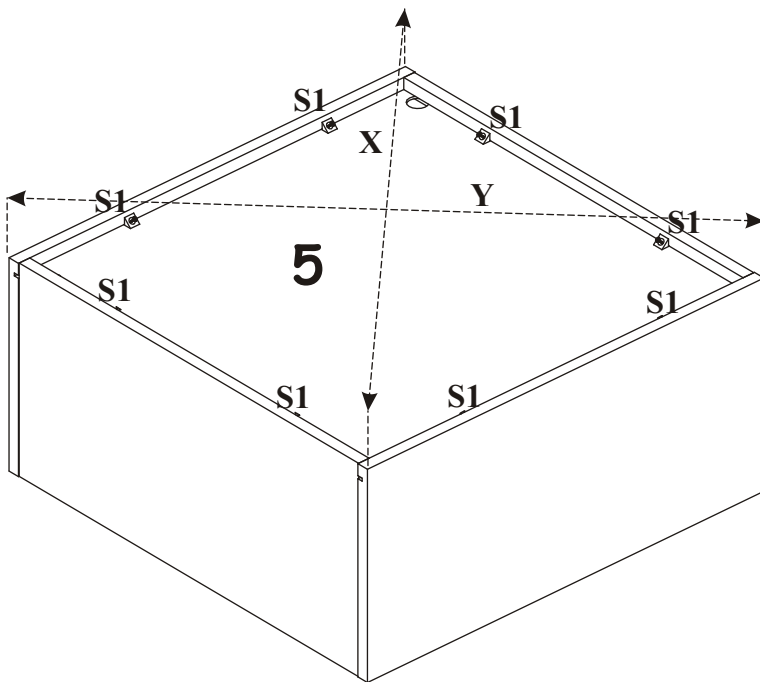

$X=Y$ \uparrow 90°

SWITCH - SW3

5

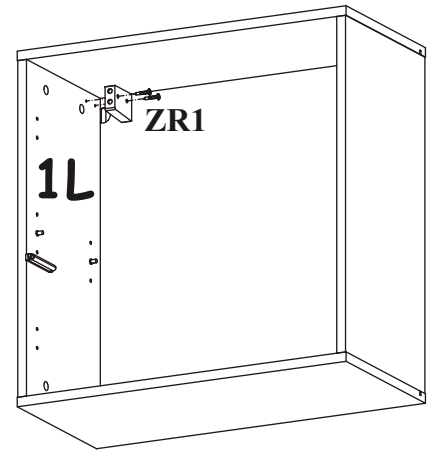
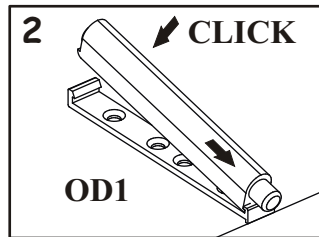
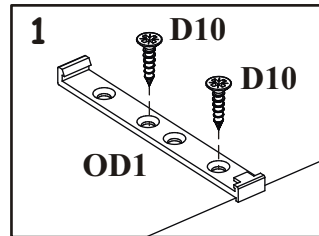
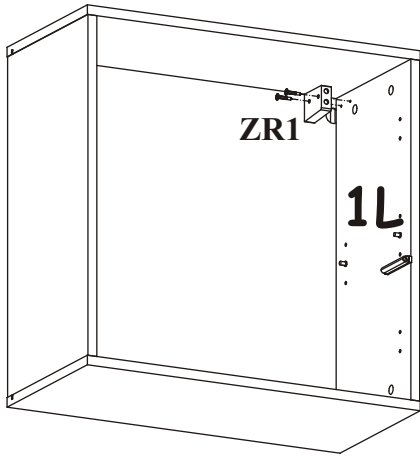
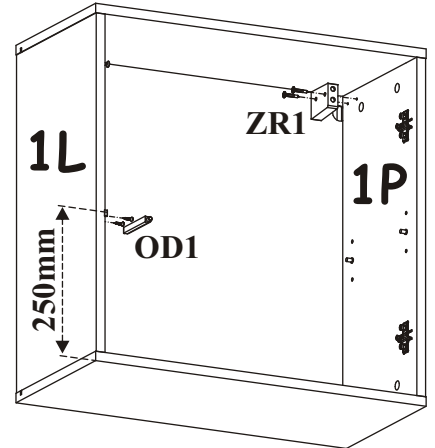
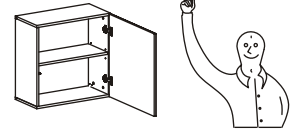
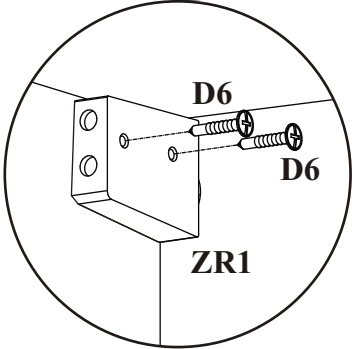
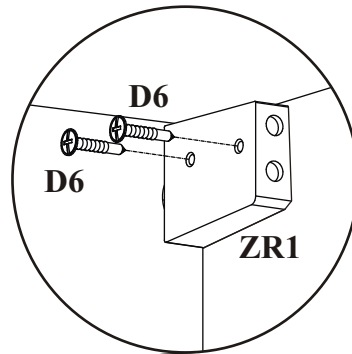
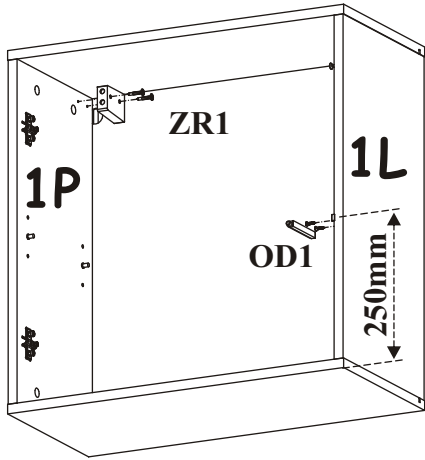
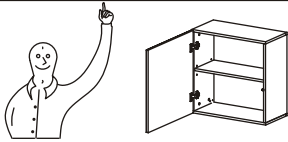

6

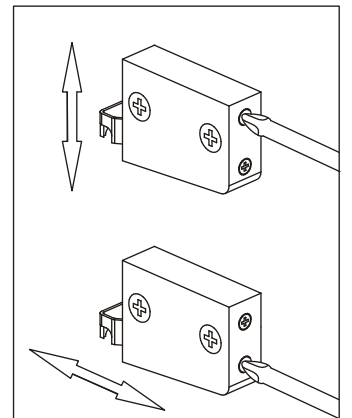
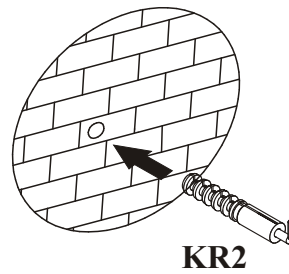
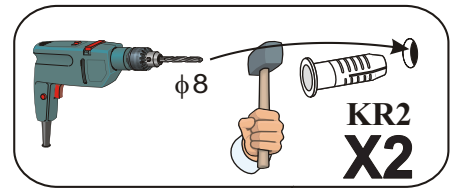
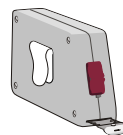
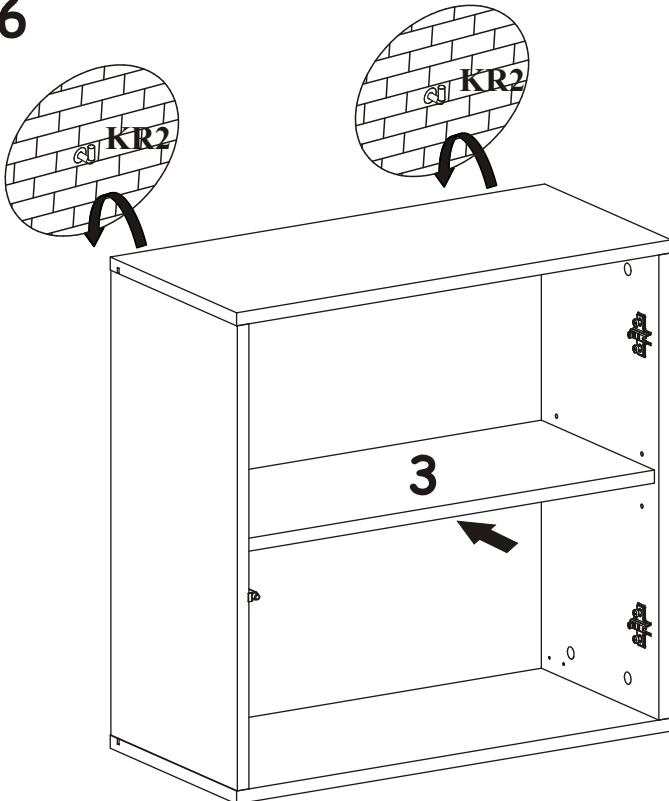

7

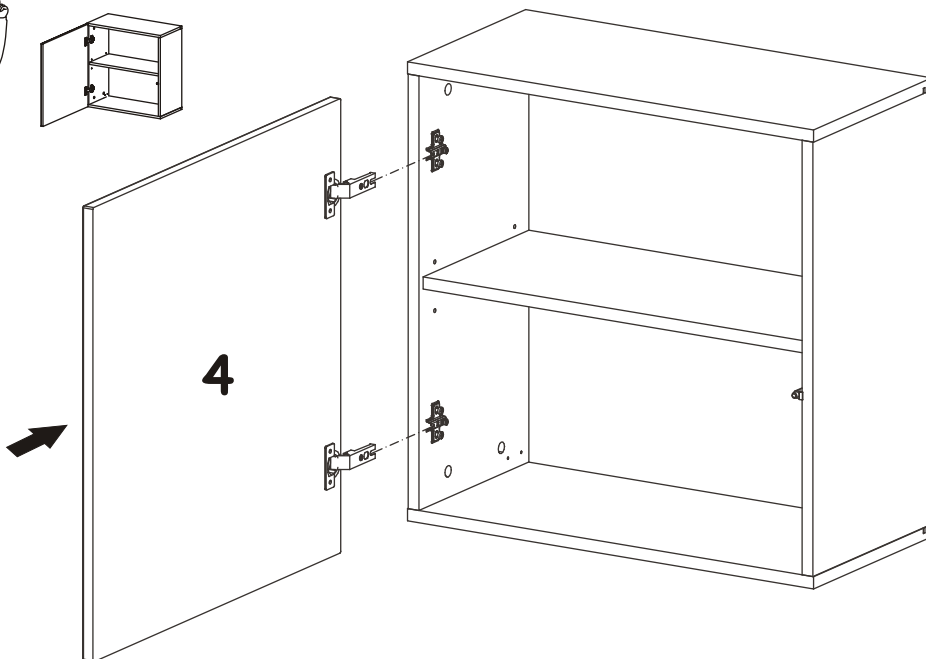
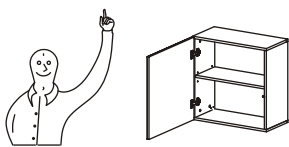
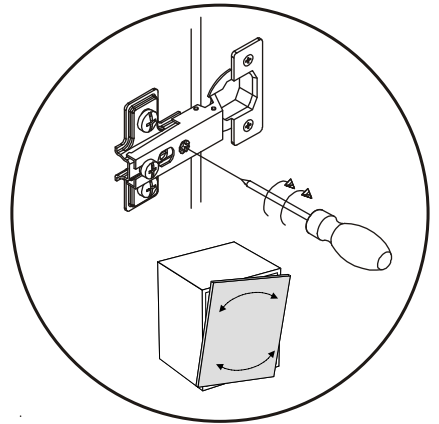
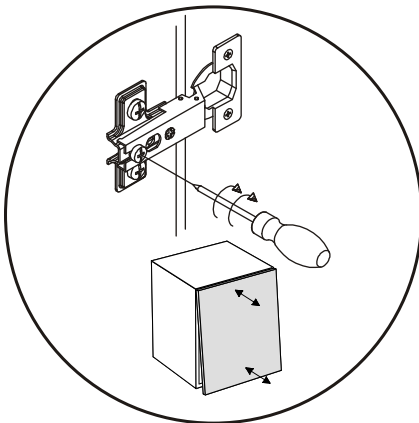
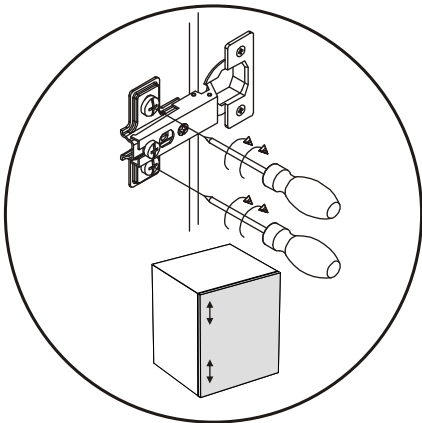
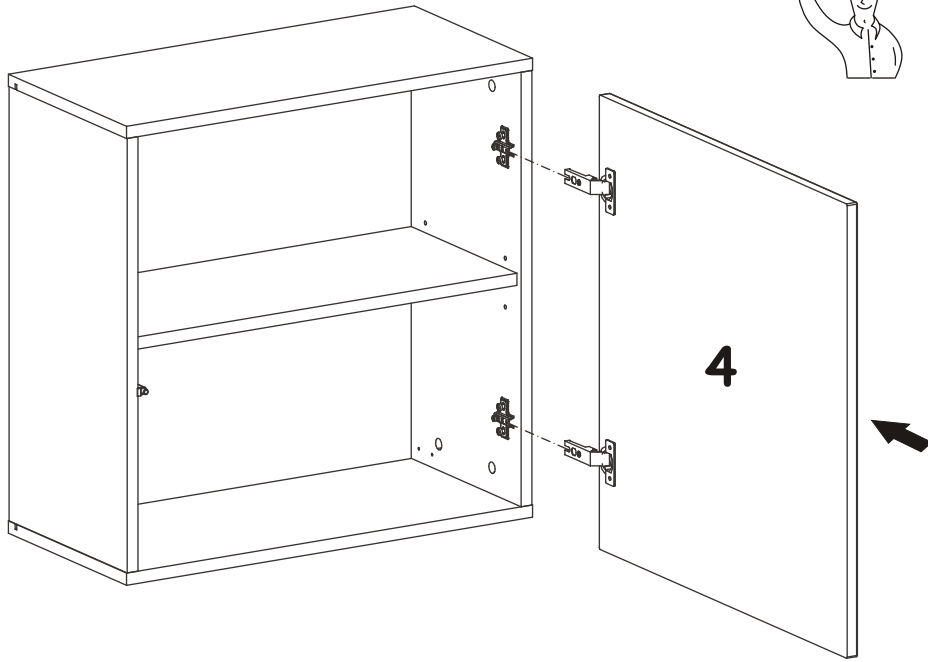
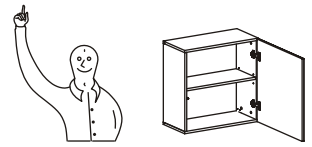

SWITCH WTL SW3

G1	
x2	Ø26

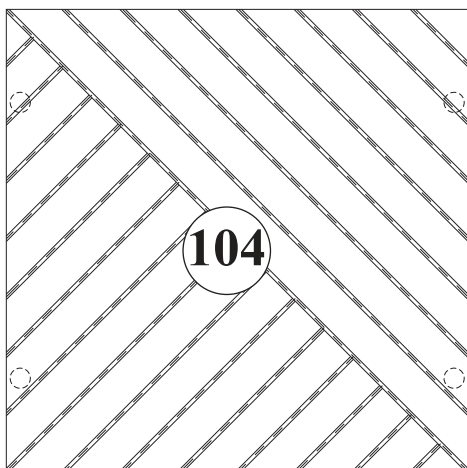
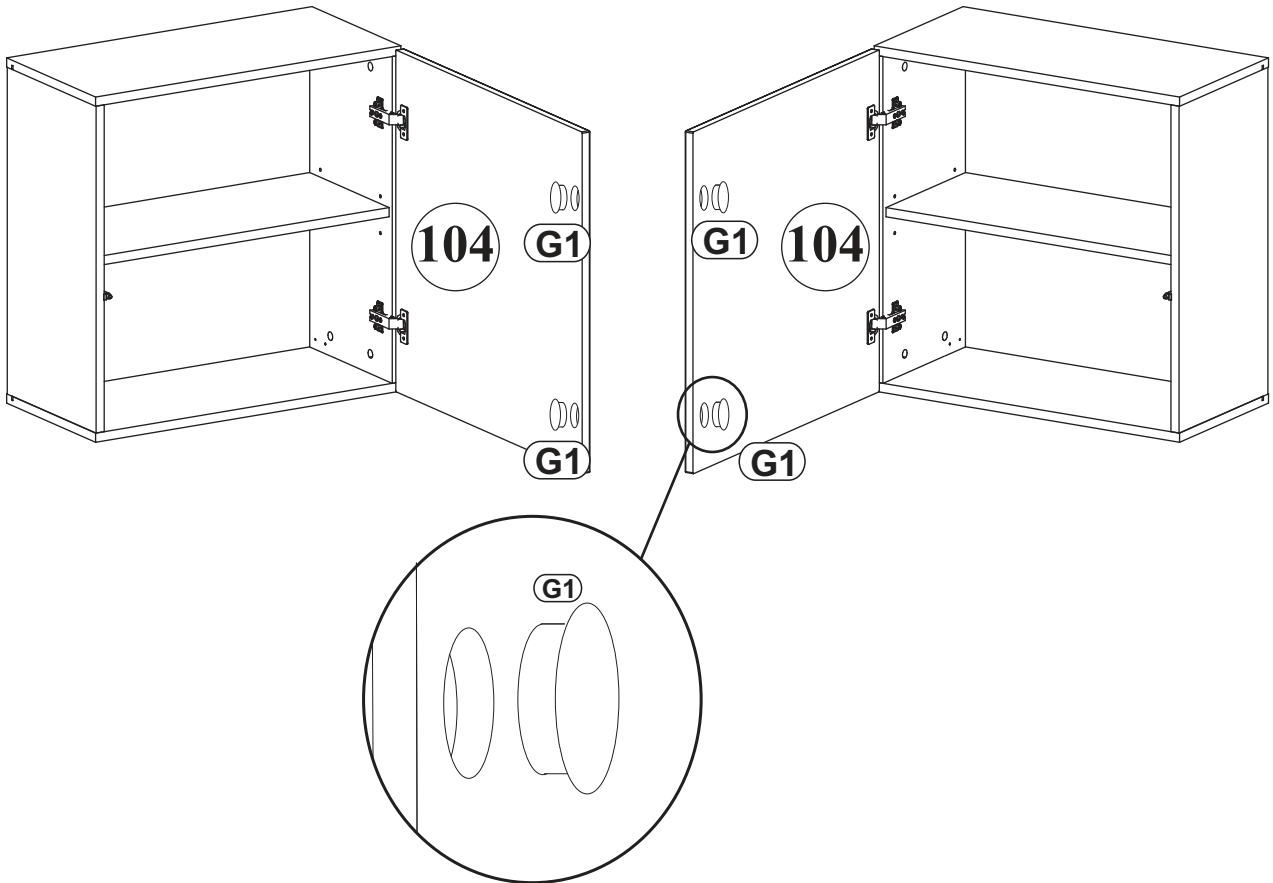

180°

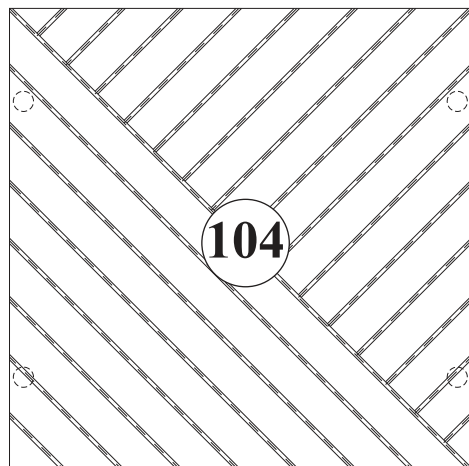

SWITCH PW 2

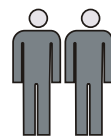
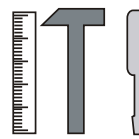
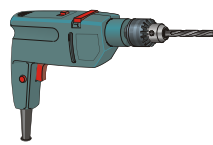
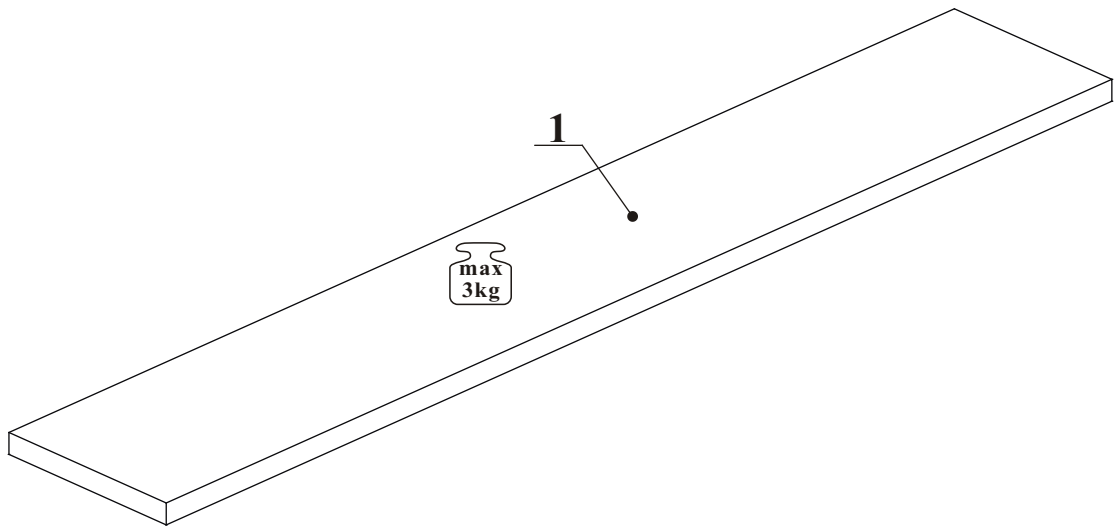
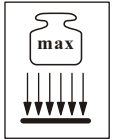

10 min

NO	Dim.		Col.-No	Qty
1	1202	200	1	1

SWITCH PW 2

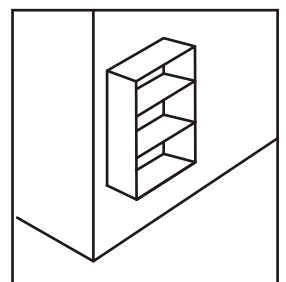
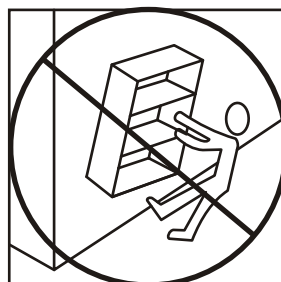
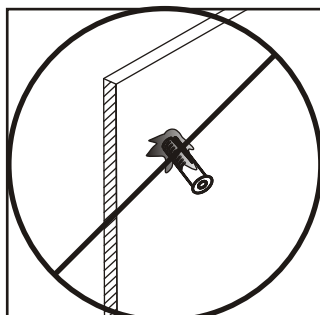
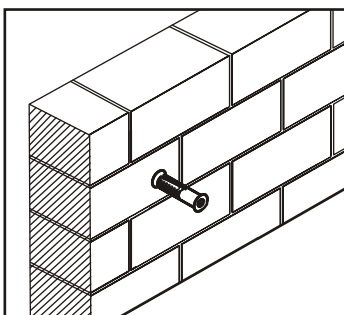
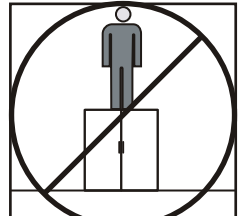
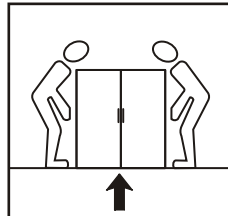
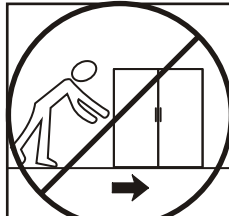
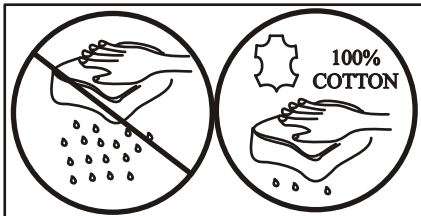
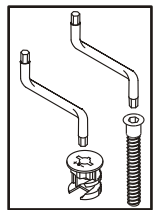
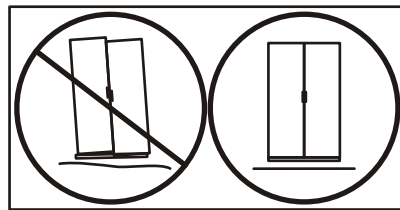
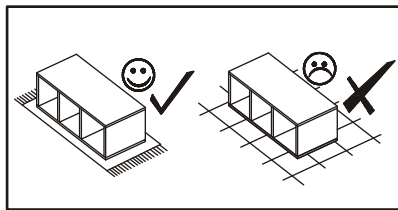
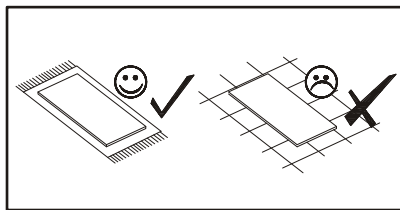
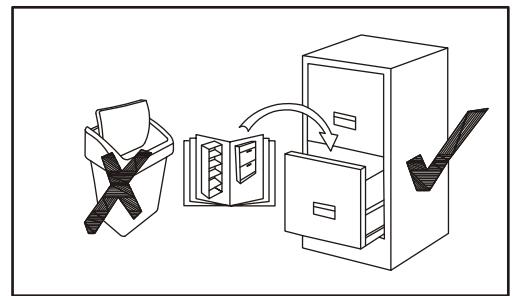
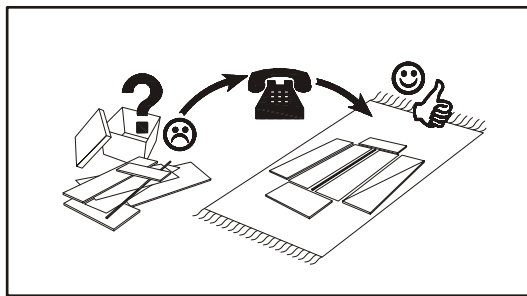
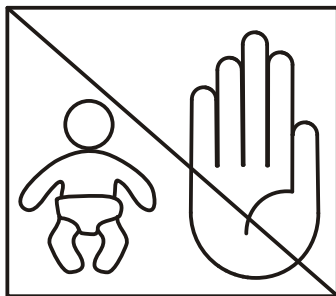
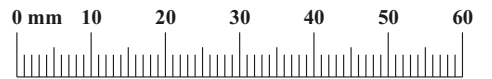
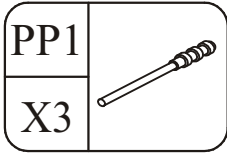

SWITCH PW 2

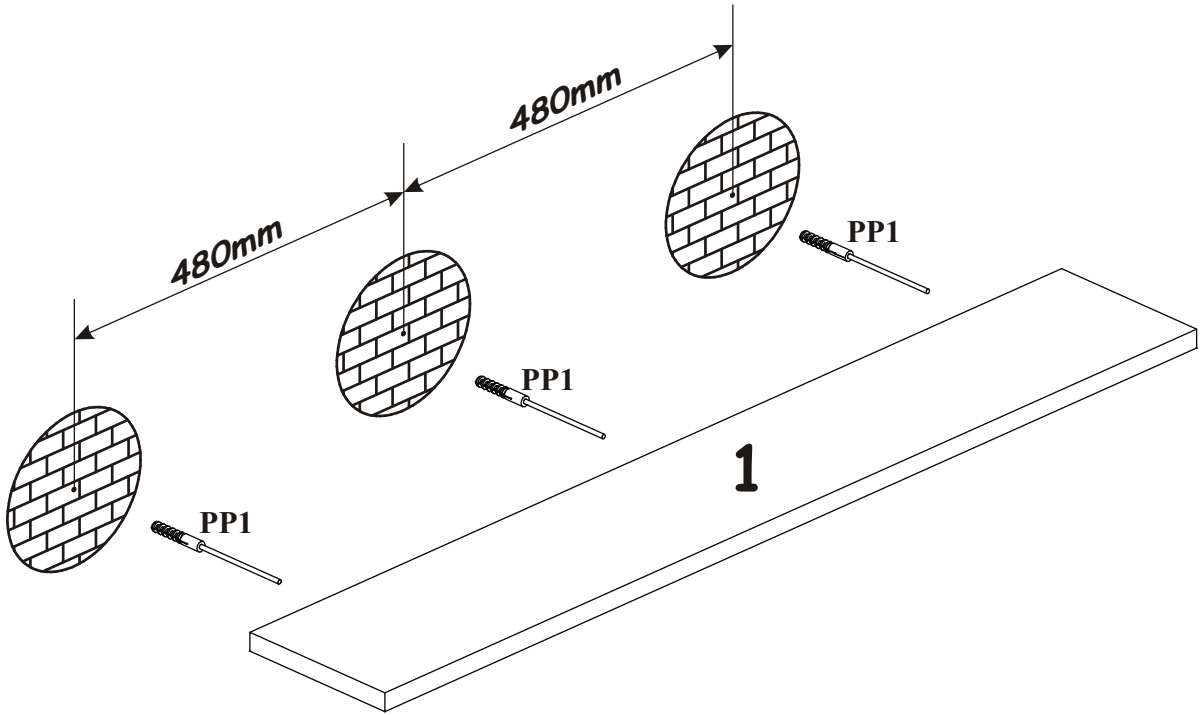
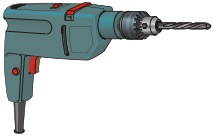

SWITCH RTV 1

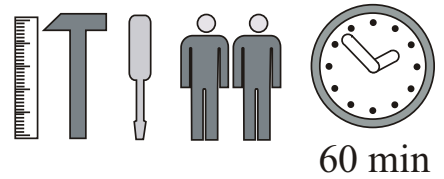
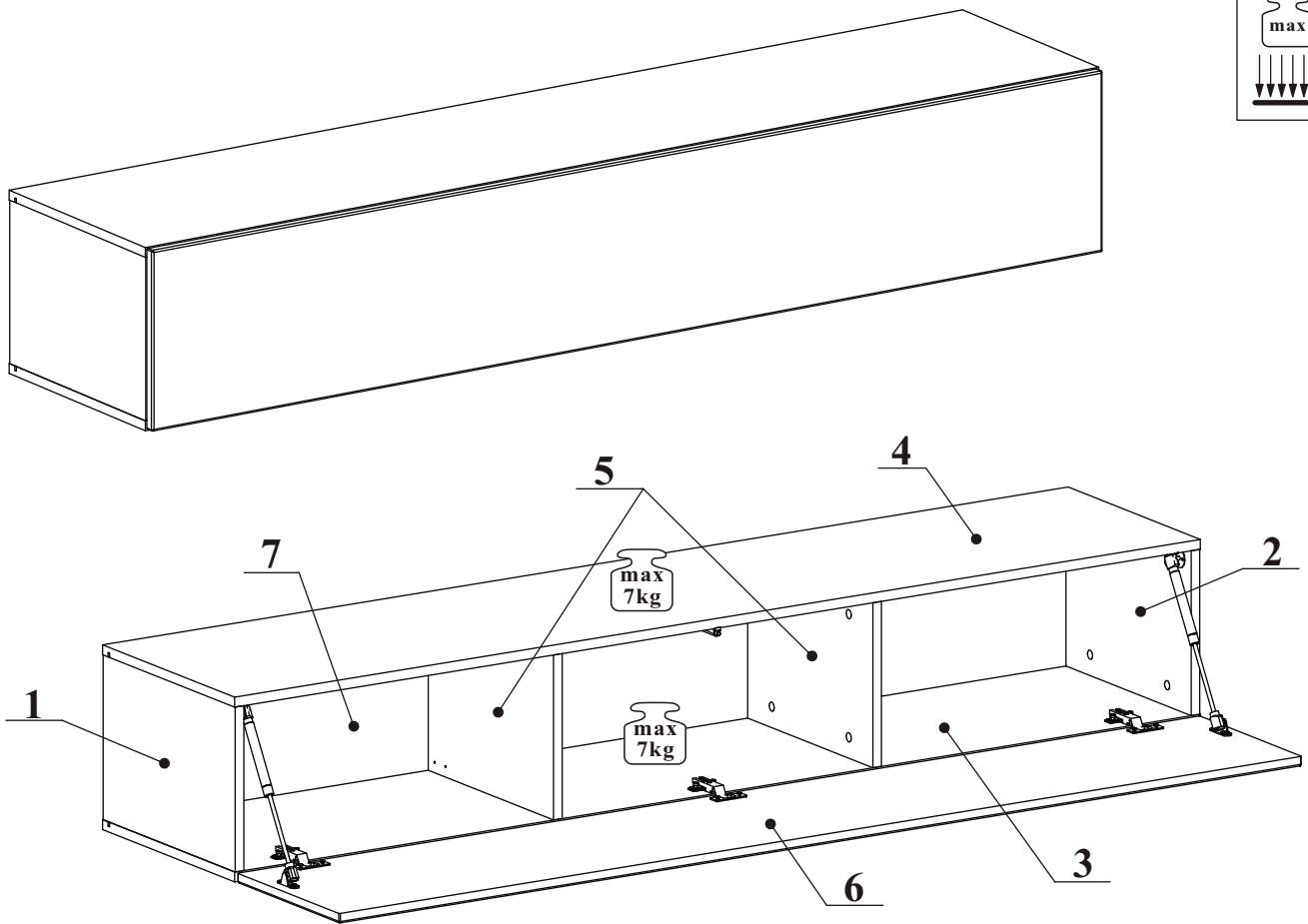
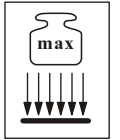

NO	Dim.		Col.-No	Qty
1	268	384	1	1
2	268	384	1	1
3	1802	384	1	1
4	1802	384	1	1
5	268	364	1	2
7	1780	280	1	1
6	1796	296	1	1

SWITCH RTV 1

A1 X16 ø8x36	B4 X16	G5 X16	B5 X16 ø15x12	ZR1 X4	D6 X8 USØ3,5x30
E1 X3 Ø26 H=0	E2 X3 H=0	D10 X12 USØ3,5x13	OD1 X1	S1 X12	BP1 X2
KR2 X4	G2 X1				

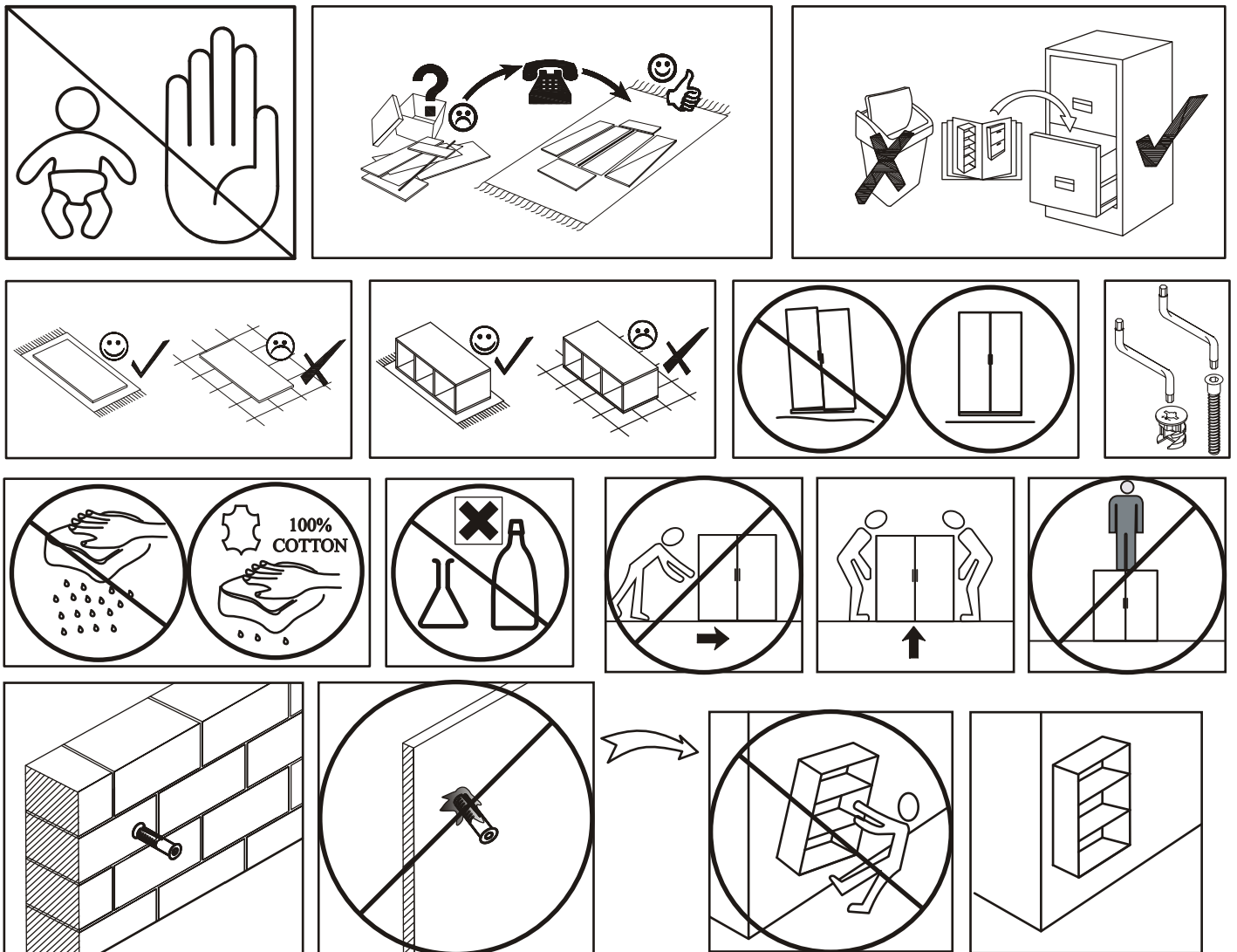
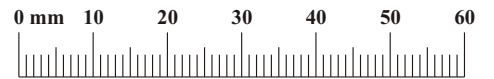

SWITCH RTV 1

1

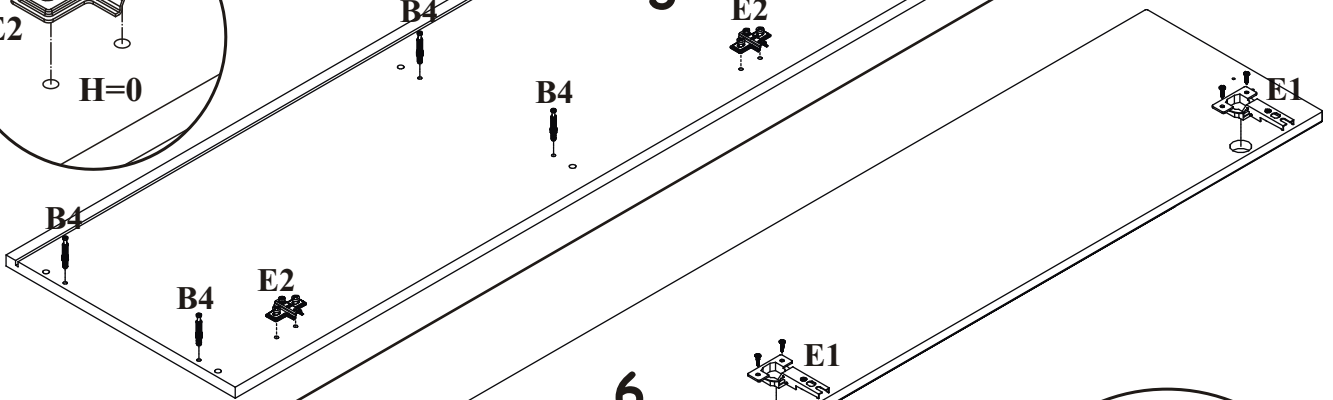
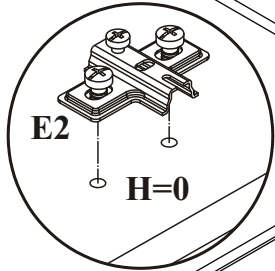
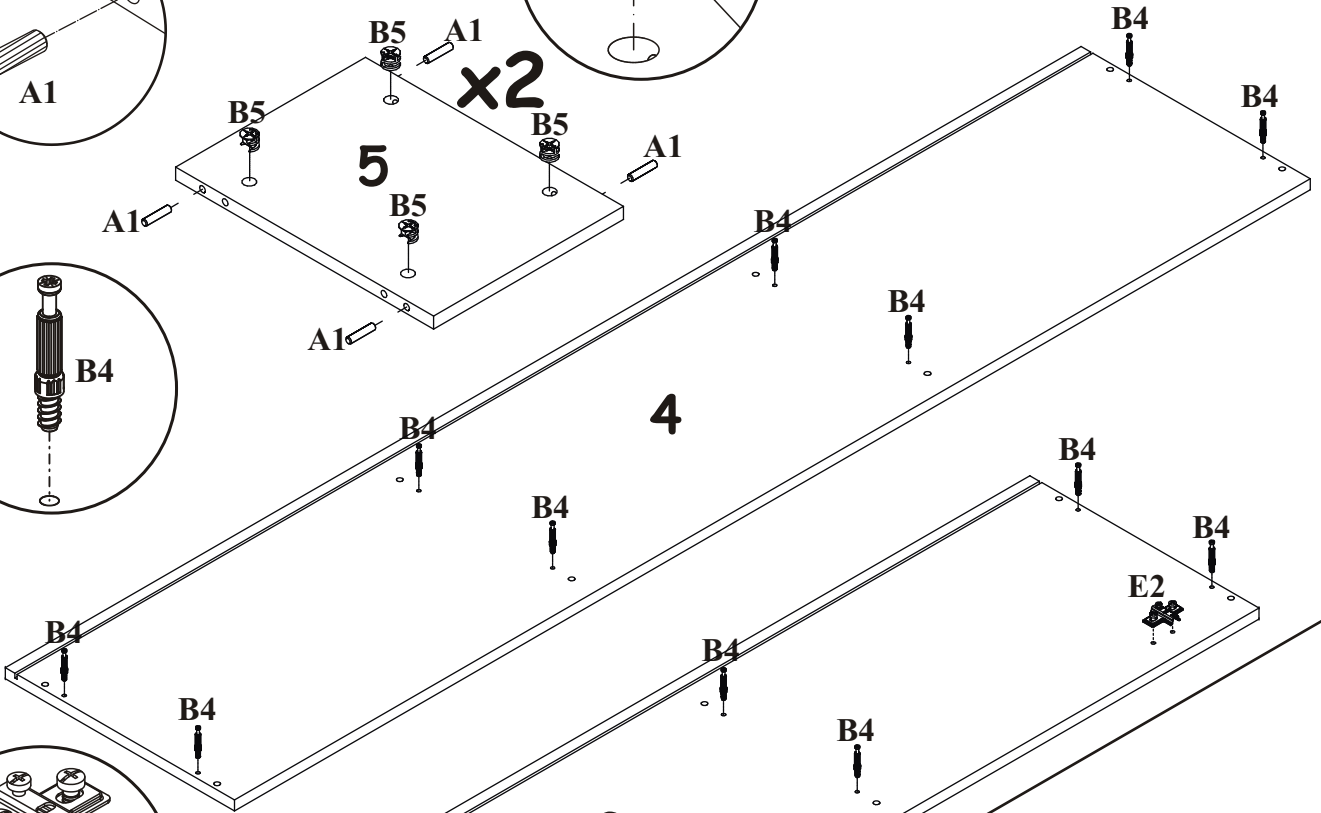
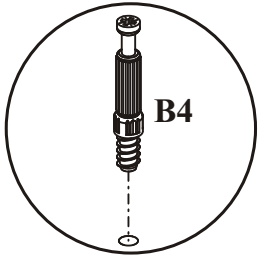
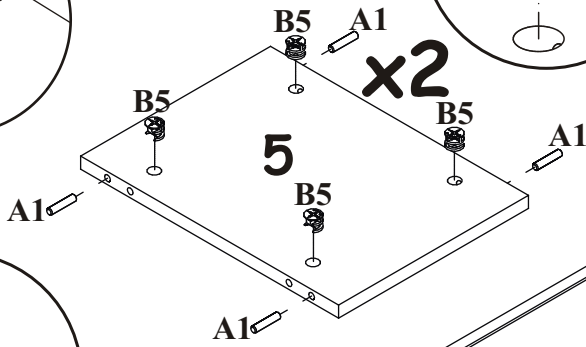
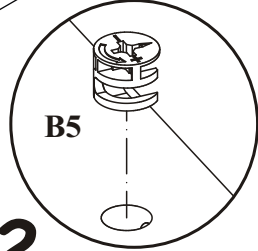
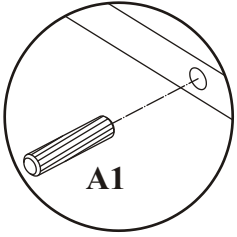
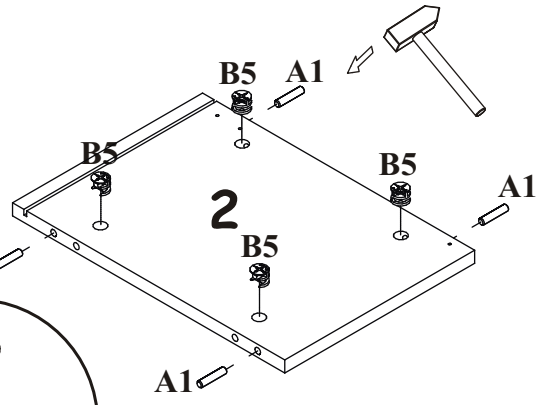
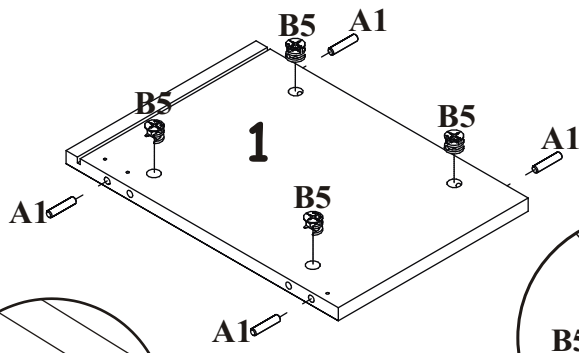

2

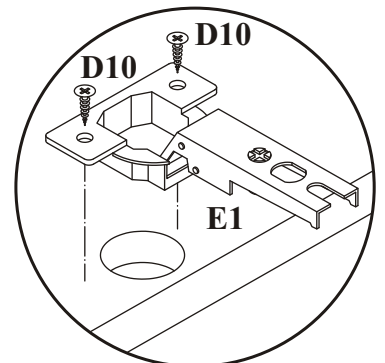
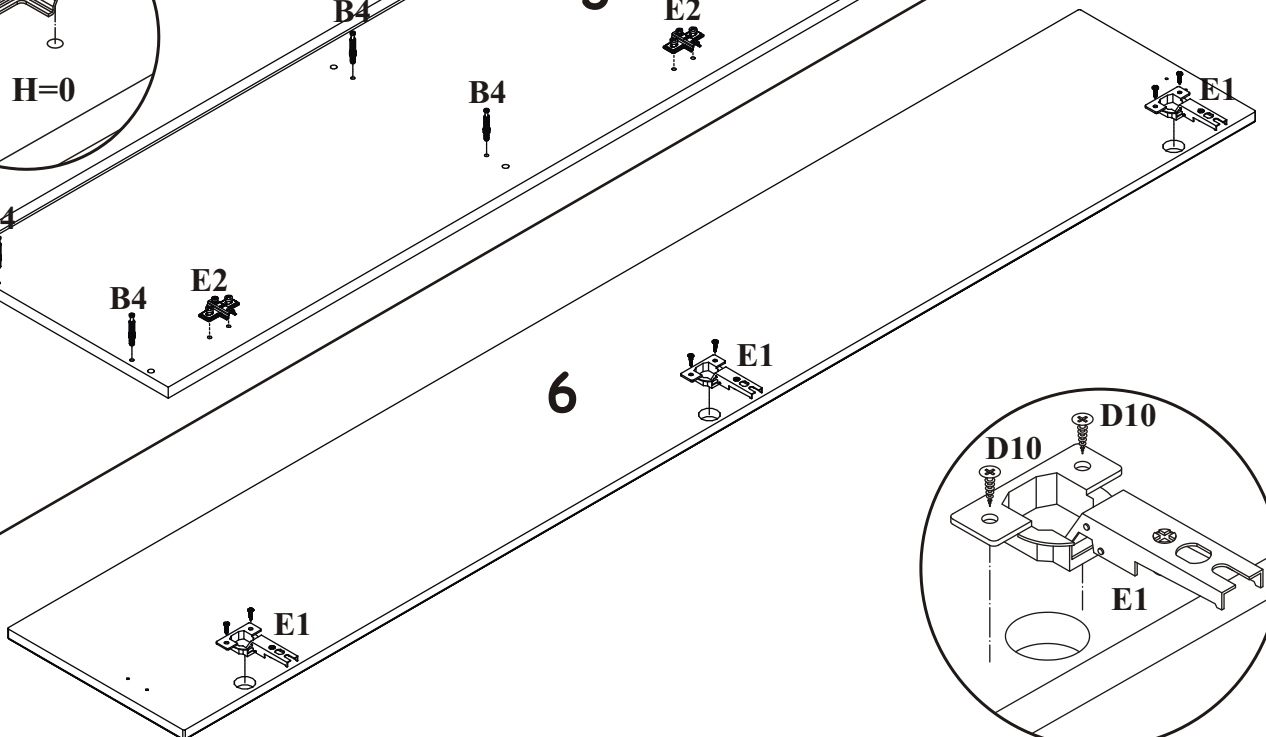

SWITCH RTV 1

3

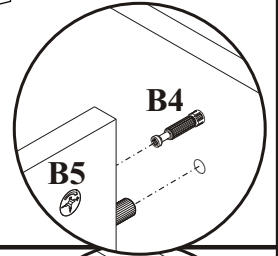
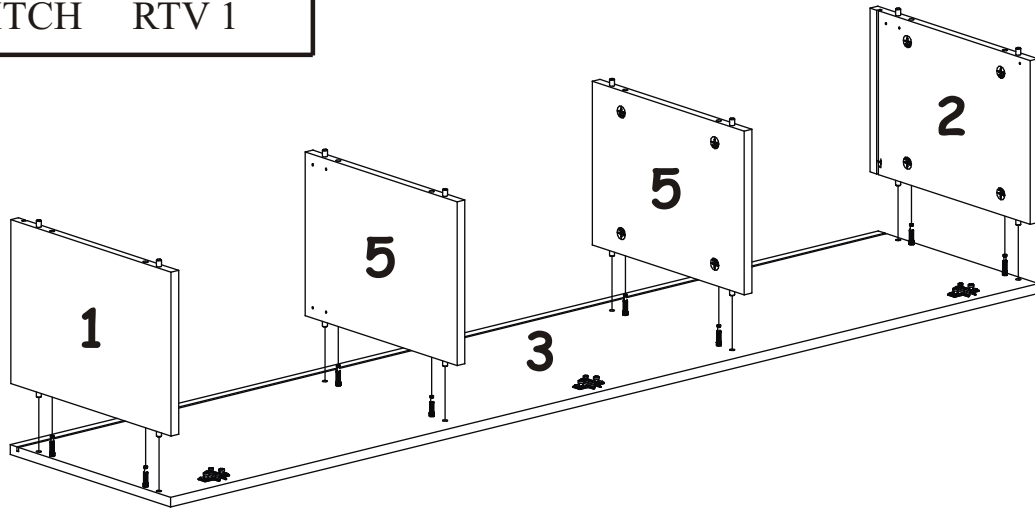

4

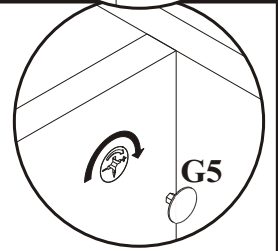
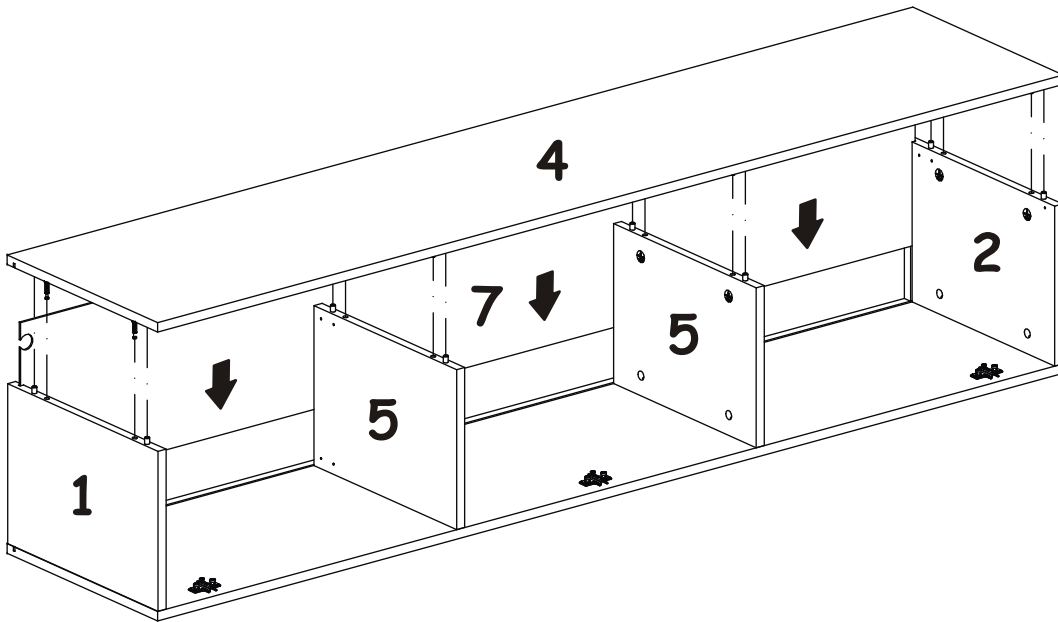

5

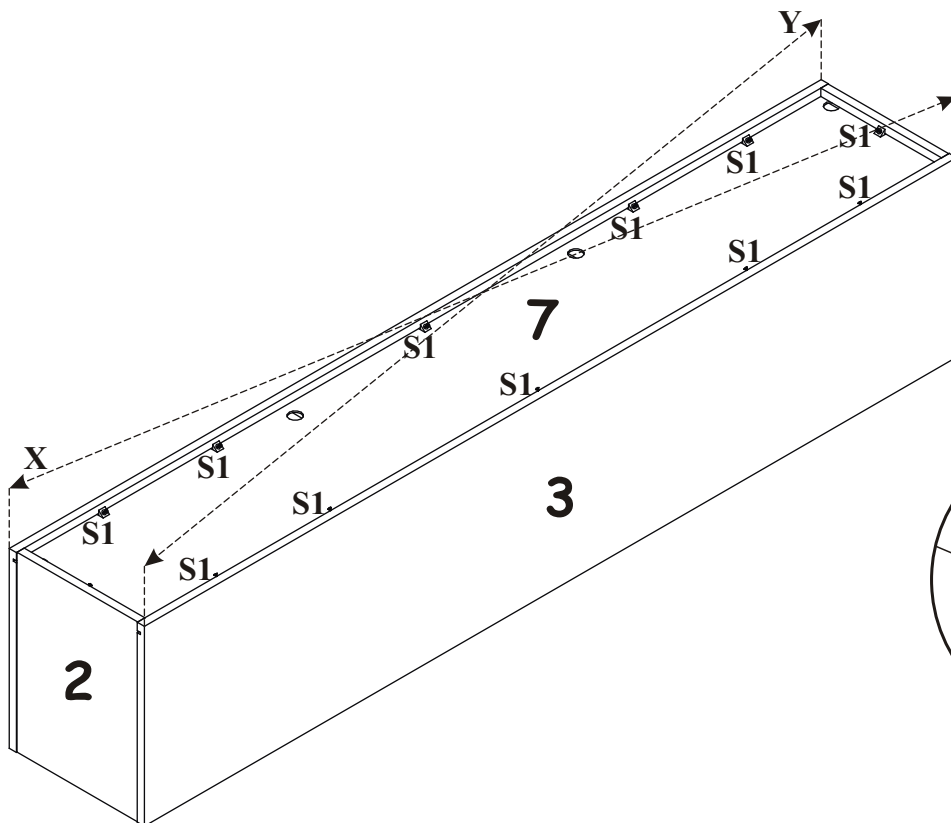

SWITCH RTV 1

6

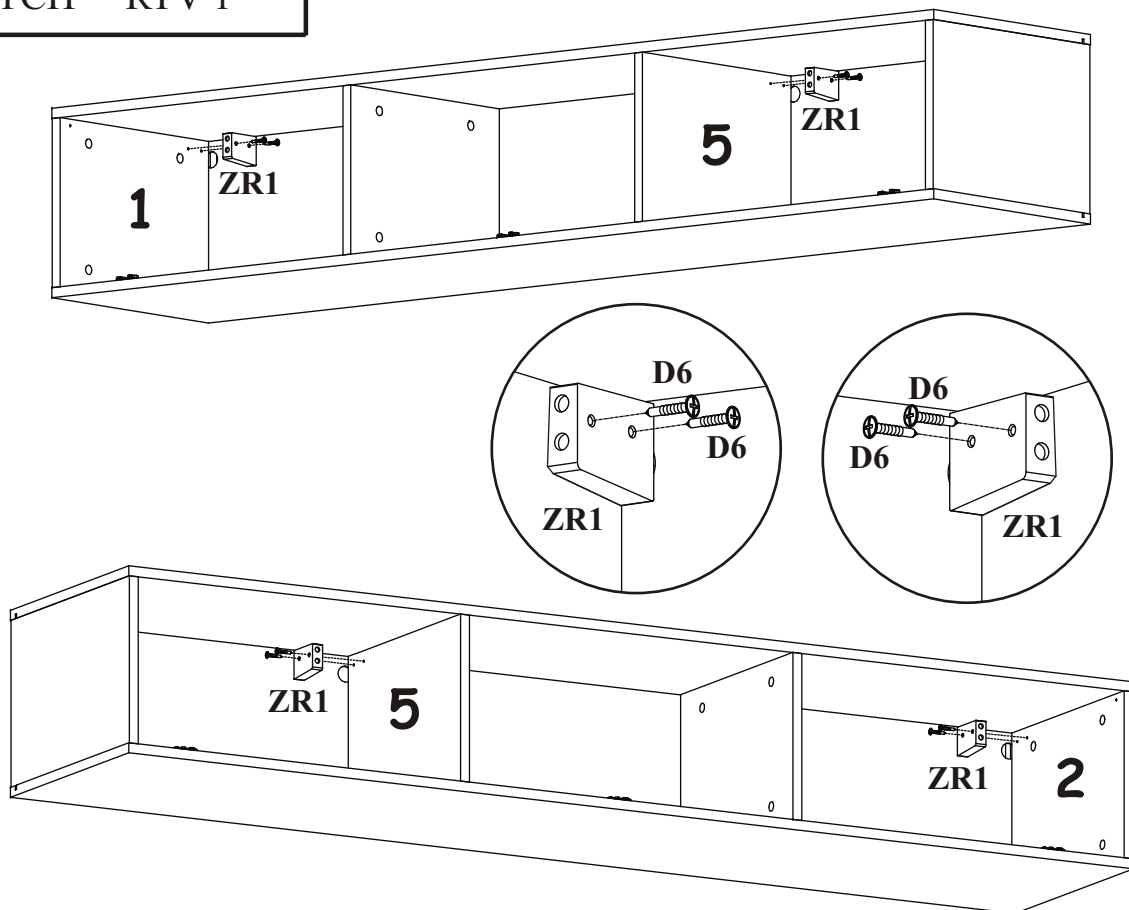

7

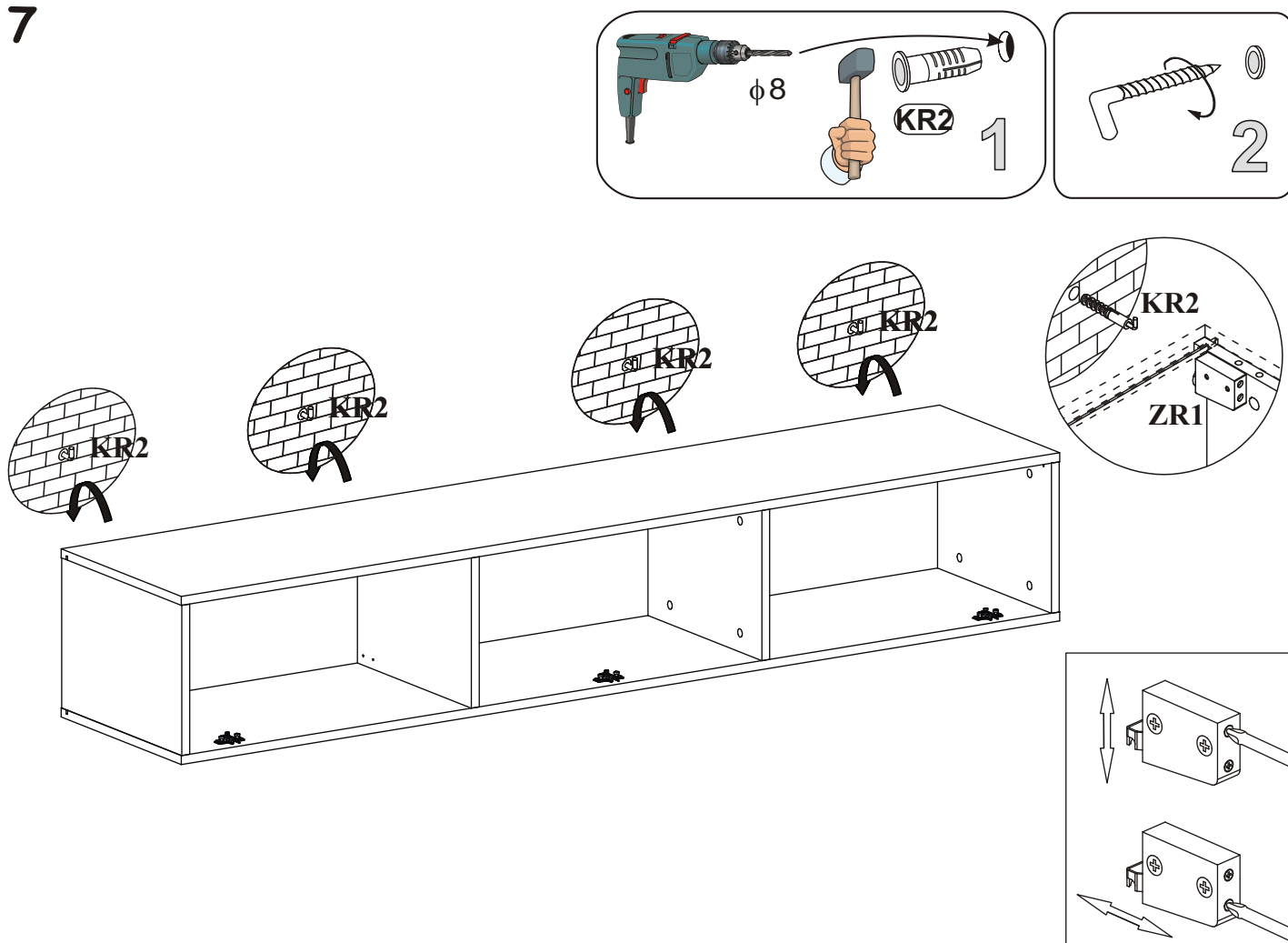

SWITCH RTV 1

8

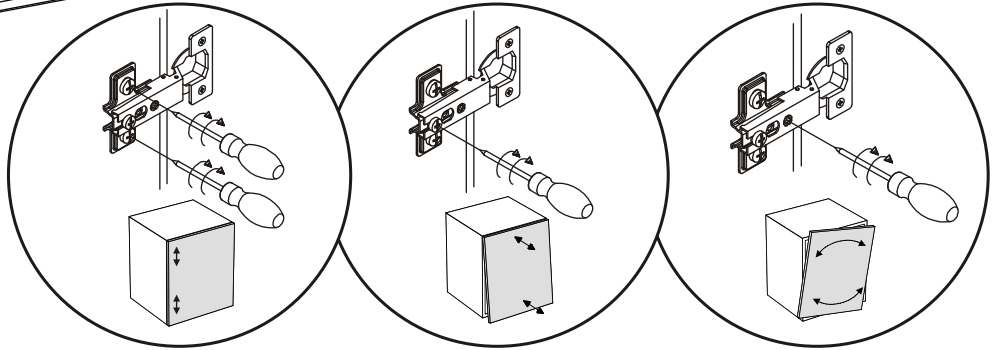
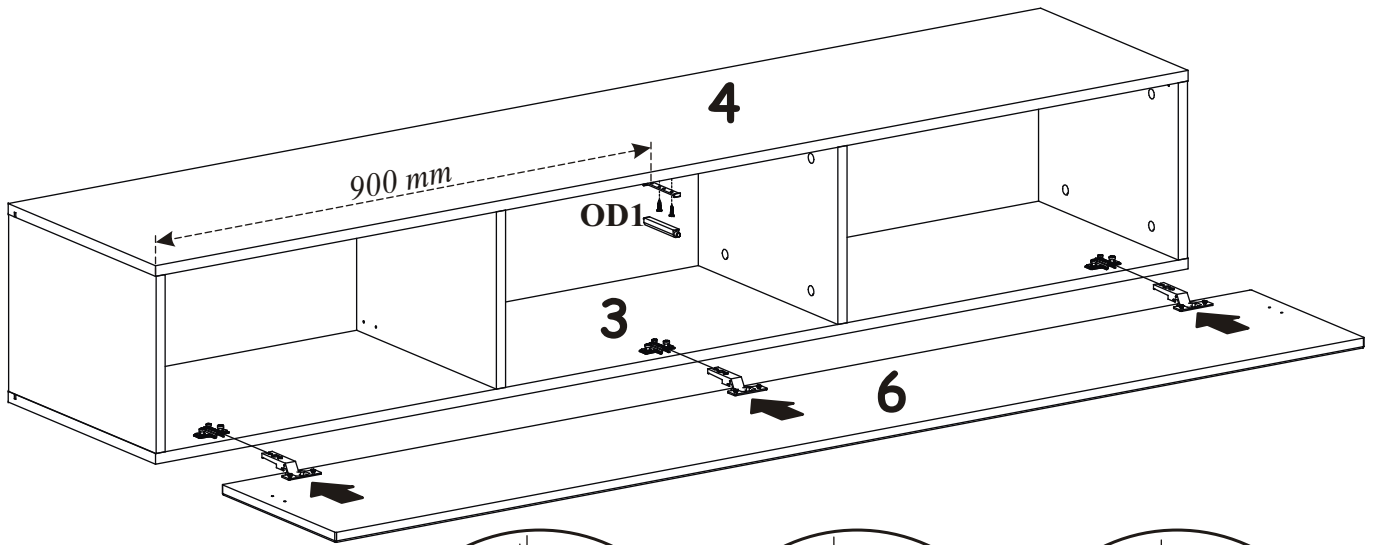
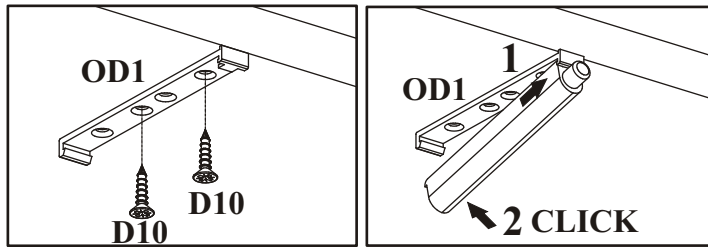

9

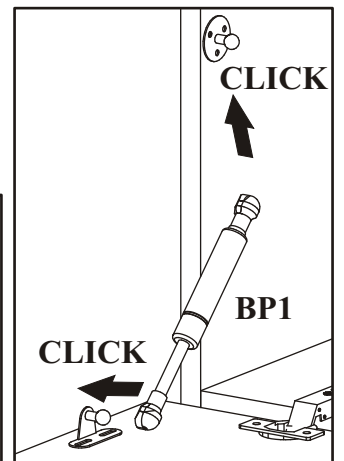
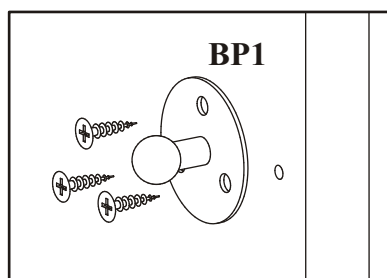
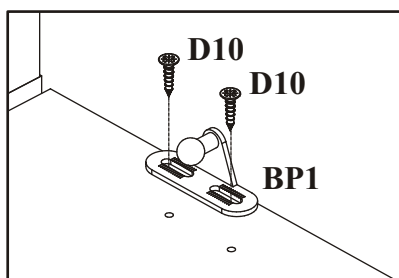
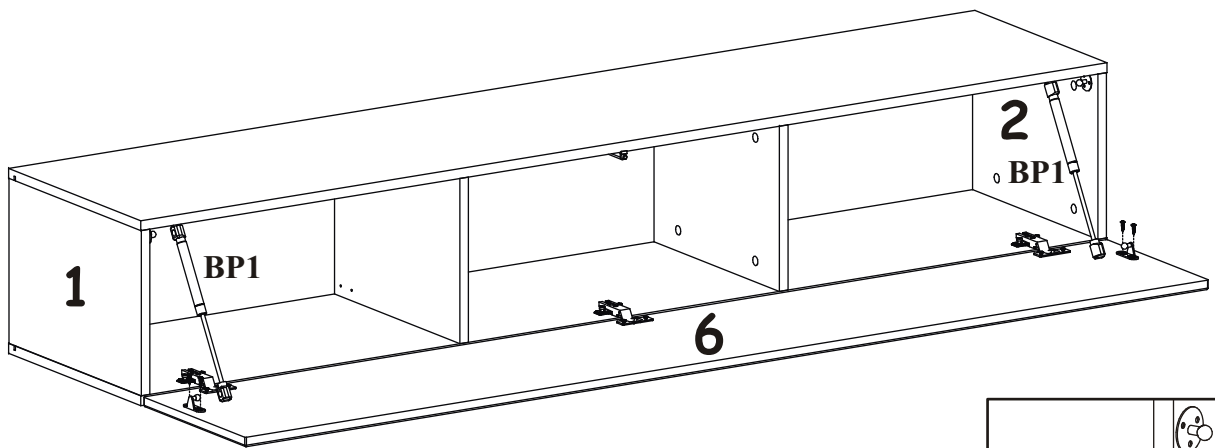

SWITCH WTL RTV1

G1	
x3	Ø26

