

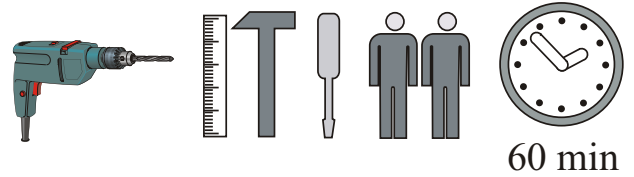

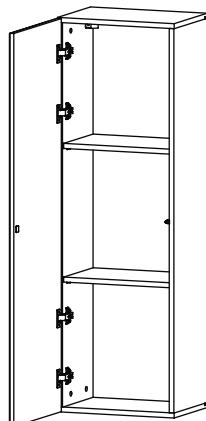

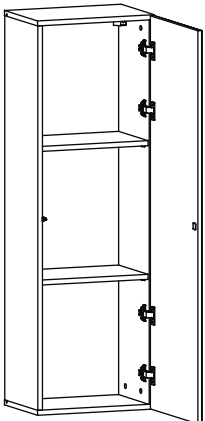

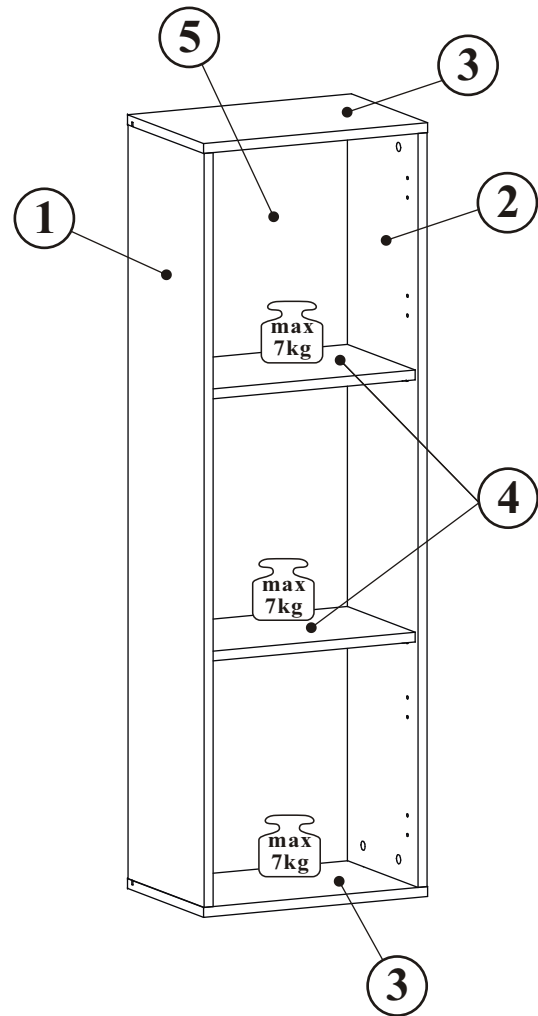

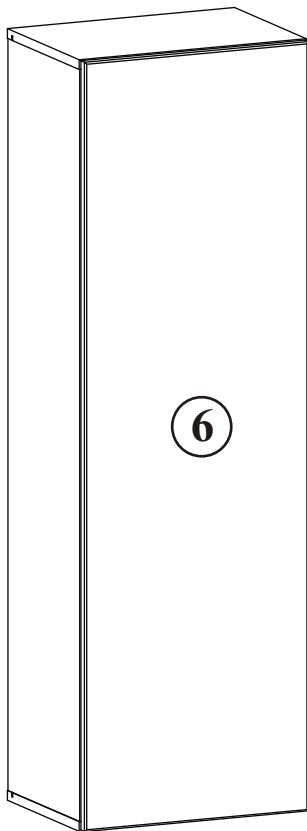
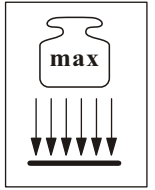
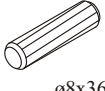
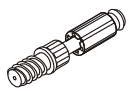

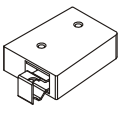
FLY 28 -- FY 20-C

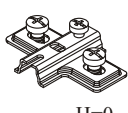
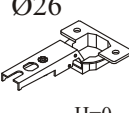

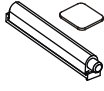
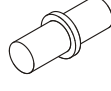
NO	Dim.		Col.-No	Qty
1	1228	274	1	1
2	1228	274	1	1
3	400	274	1	2
4	366	244	1	2
5	1240	378	1	1
6	394	1256	1	1

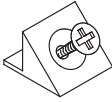
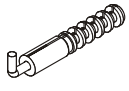
FLY 28--FY 20-C

A1 x8  ø8x36	B4 x8 	B5 x8  ø15x12	G5 x8 	ZR1 x2 	D6 x4  USØ3,5x30
E2 x4  H=0	E1 x4  Ø26 H=0	D10 x10  USØ3,5x13	AM x1 	G7 x8 	Z2 x8  Ø5
S1 x10 	KR2 x2 	G2 x1 			

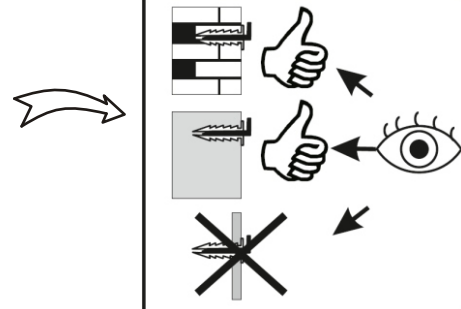
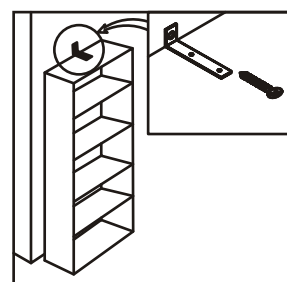
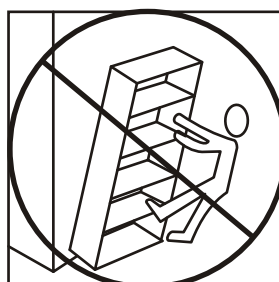
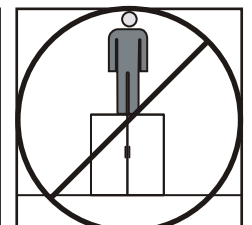
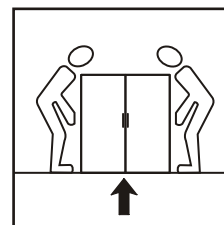
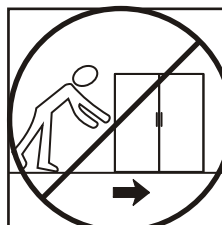
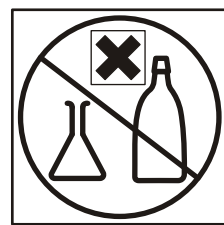
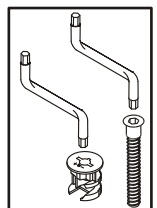
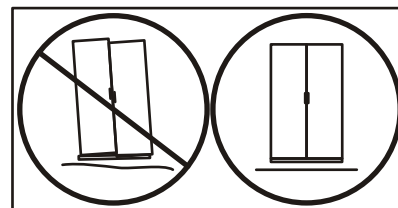
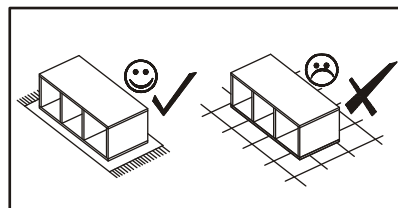
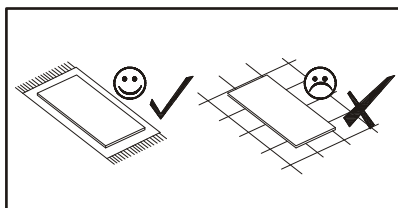
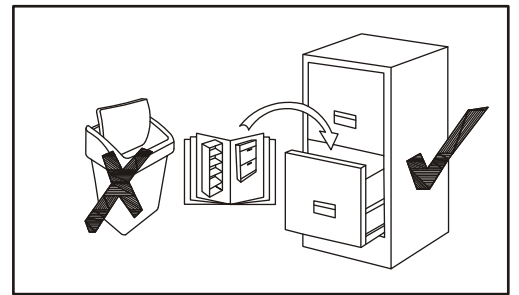
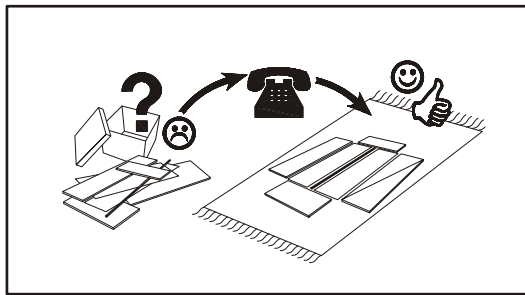
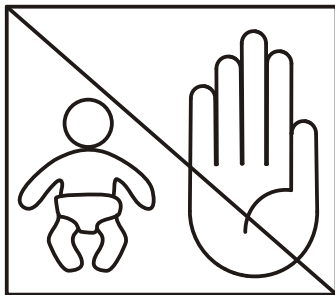
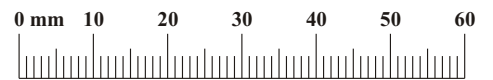

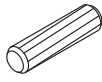
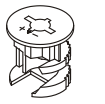
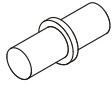
A1		B5		G7	
x8	ø8x36	x8	ø15x12	x8	

1

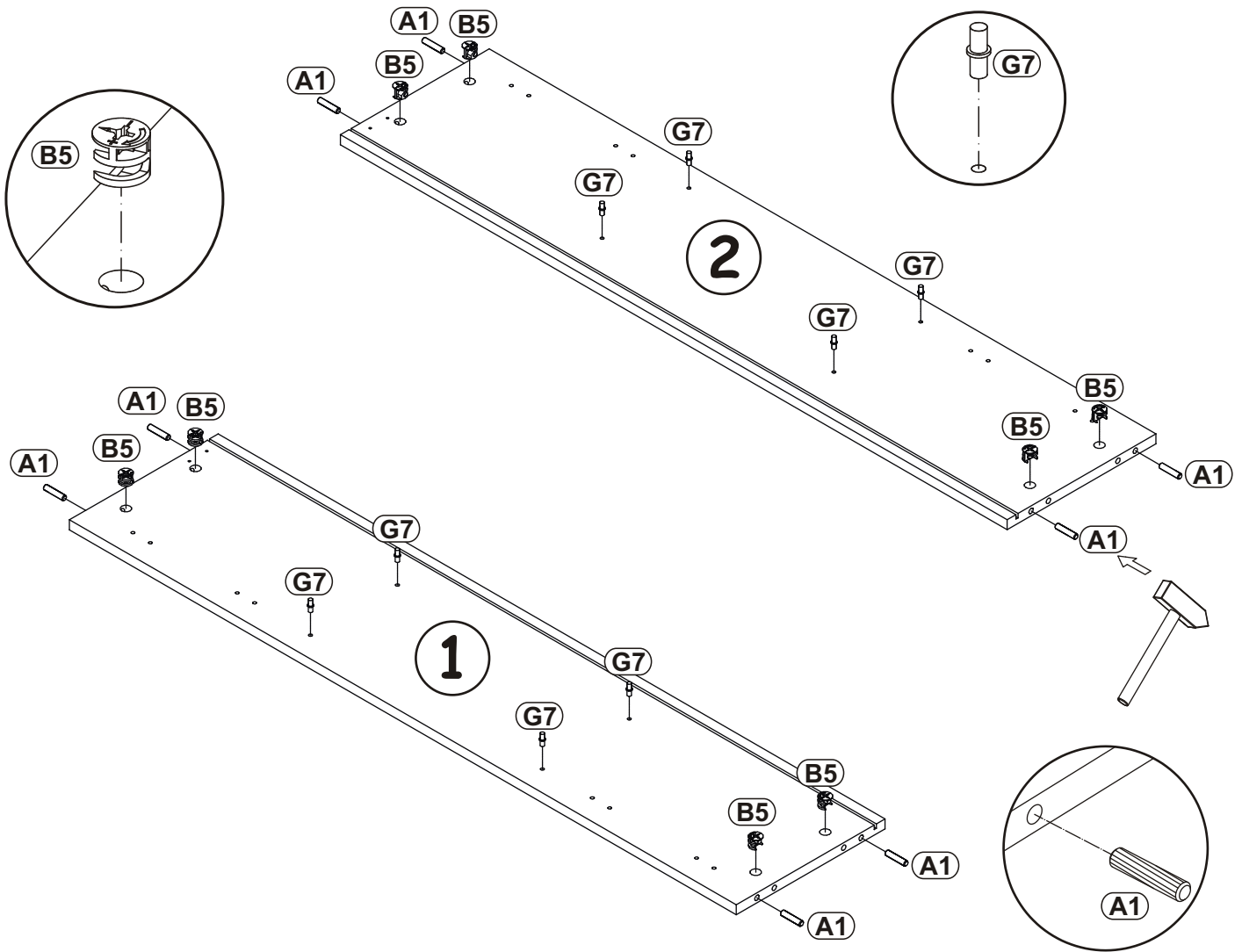

2

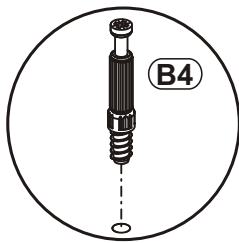

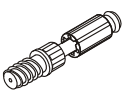
B4	
x8	

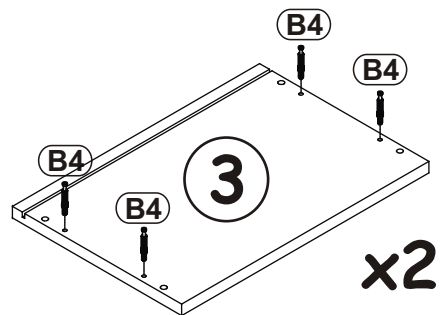

FLY 28--FY 20-C

3

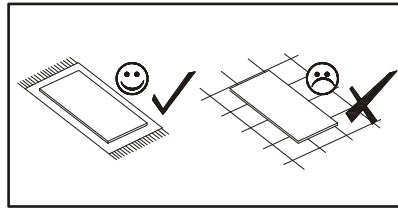

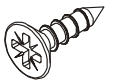

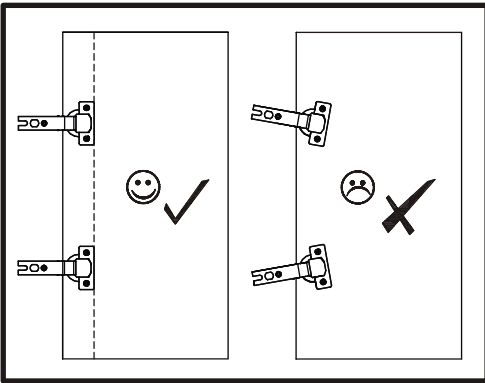
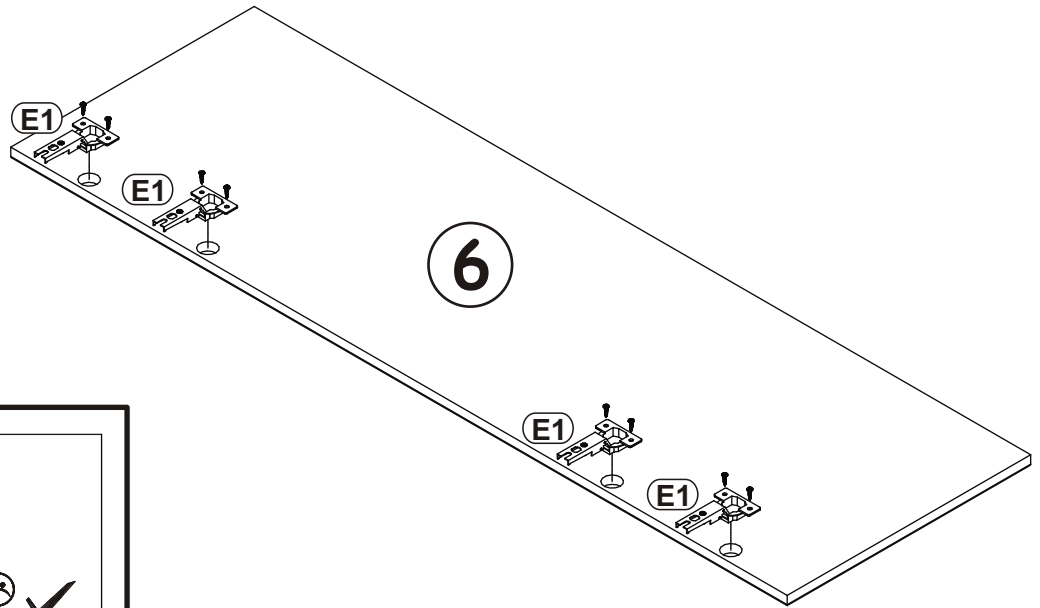
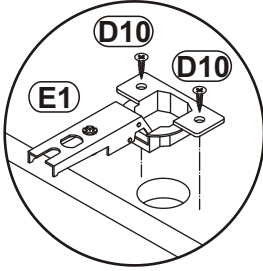
E1	Ø26	D10	 USØ3,5x13
x4	H=0	x8	

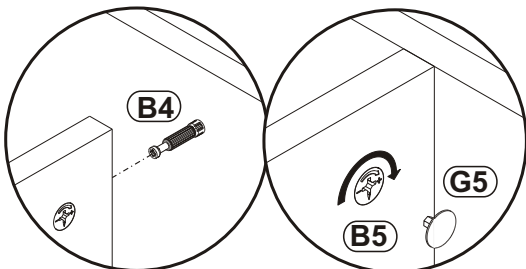
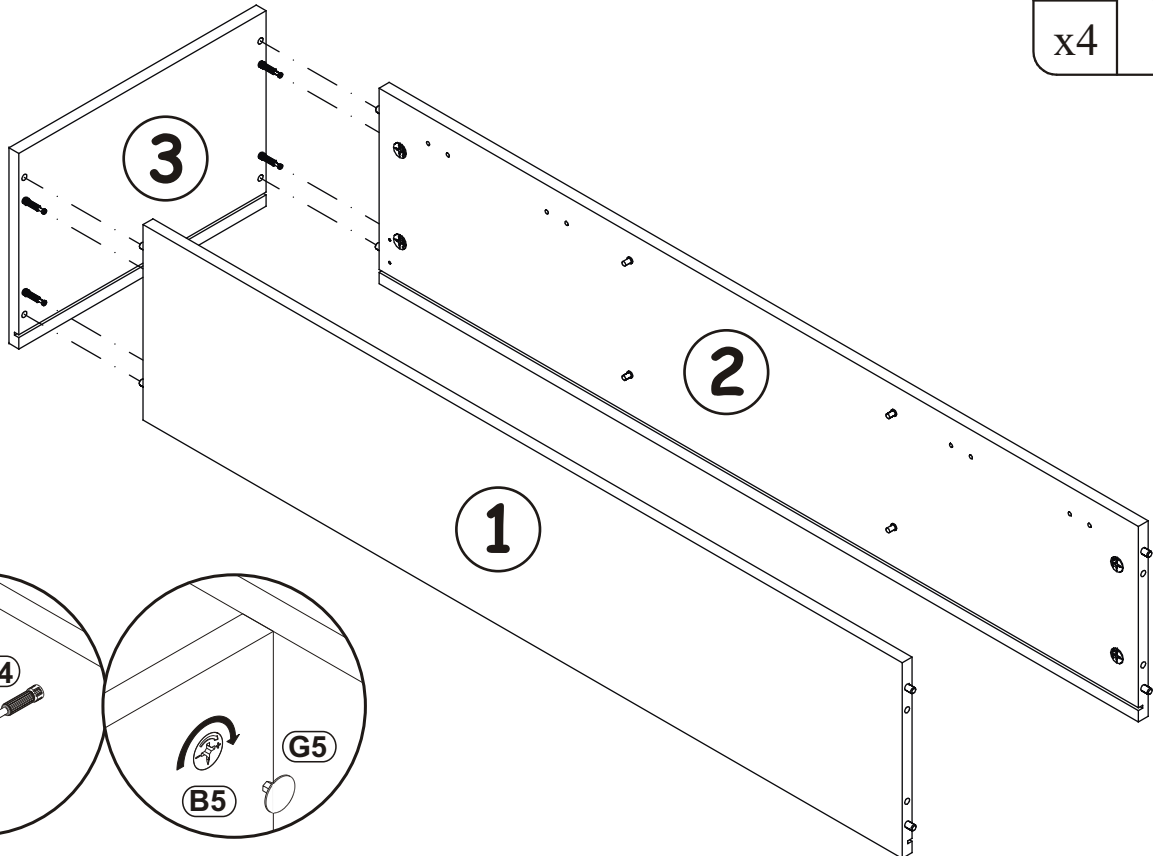

4

G5	
x4	



G5	
x4	

5

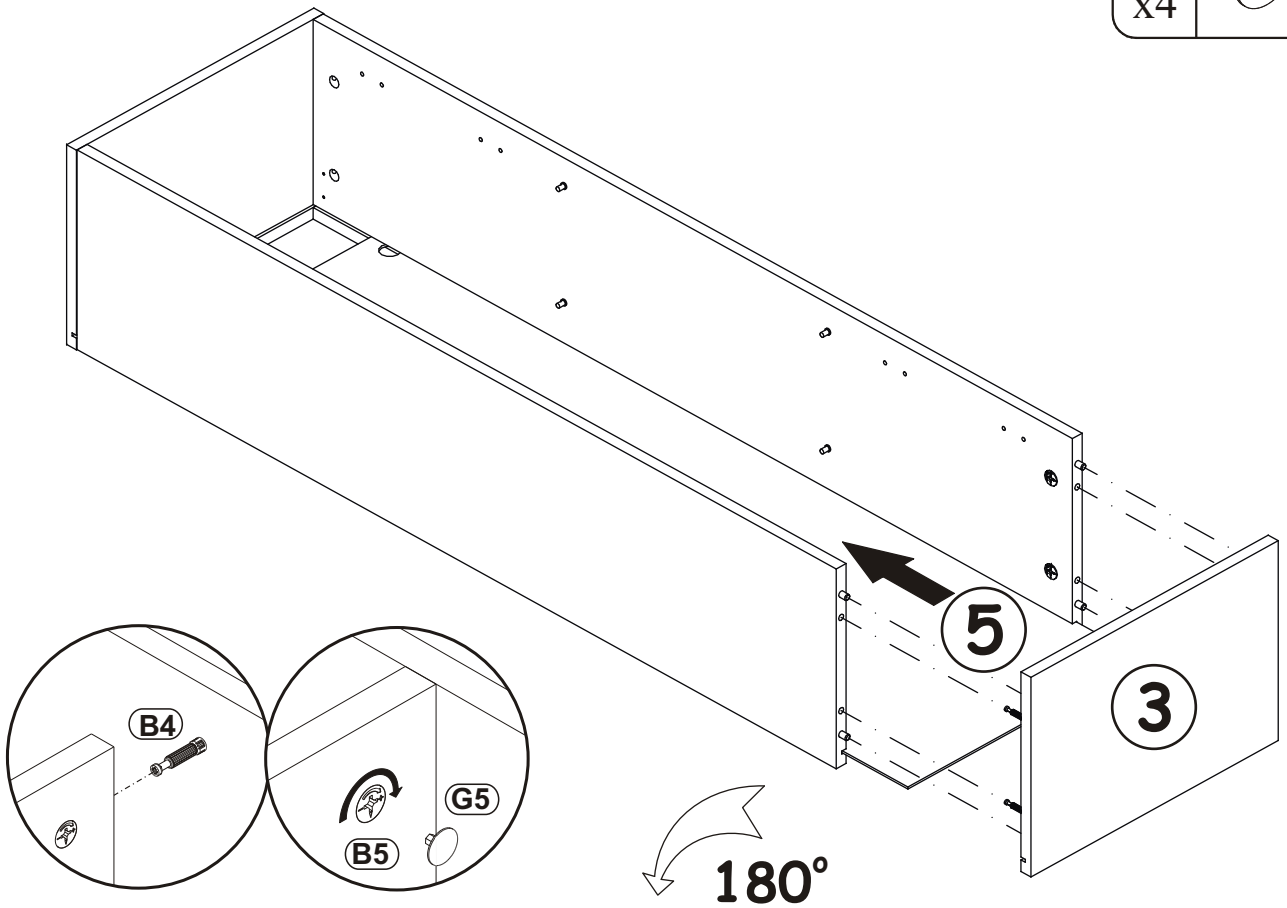

6

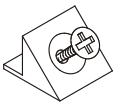

S1	
x10	

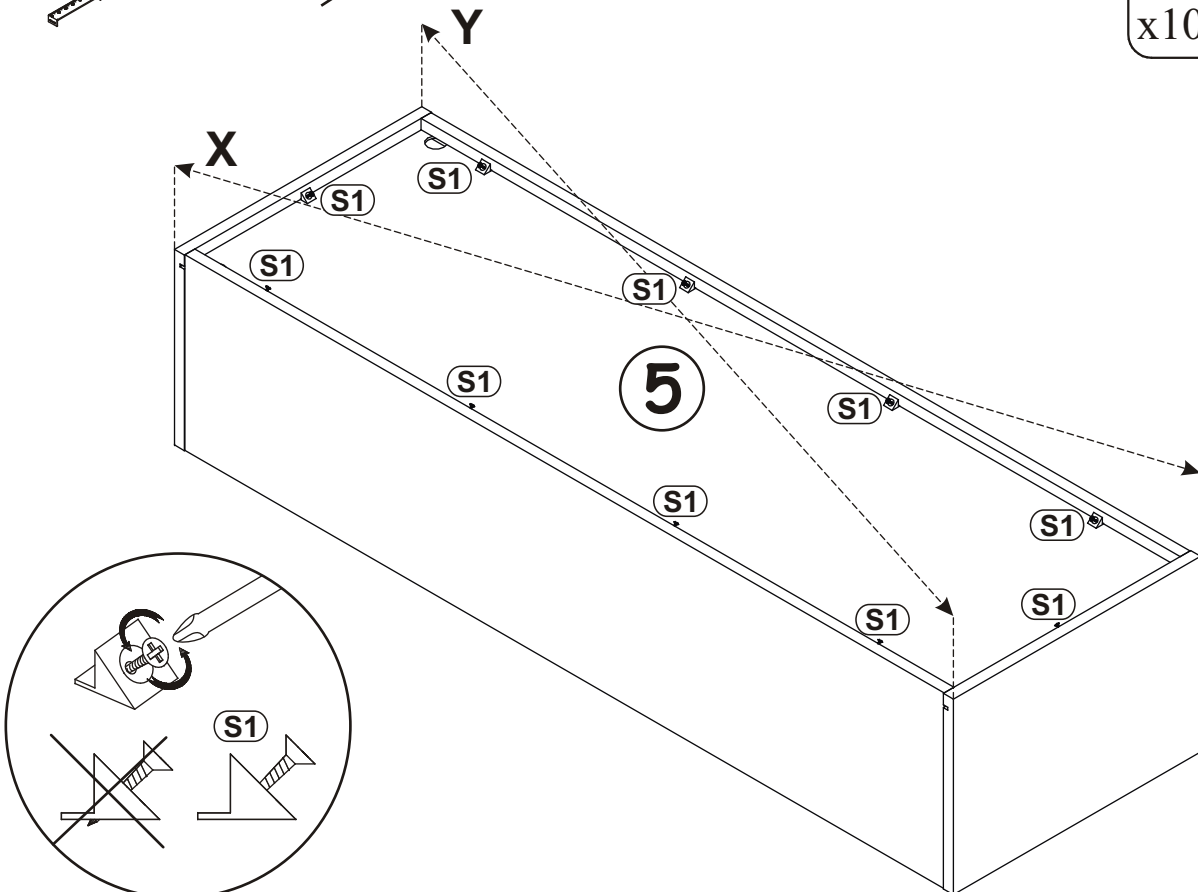

FLY 28--FY 20-C

7

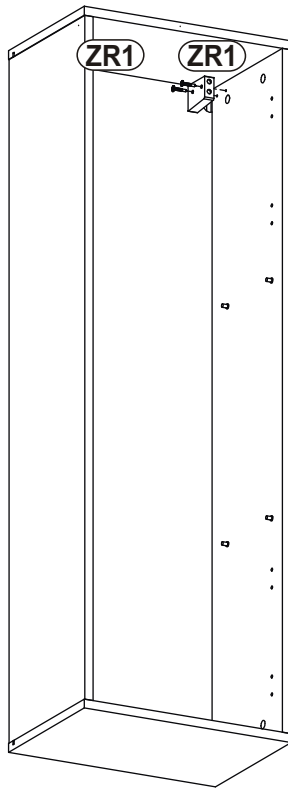
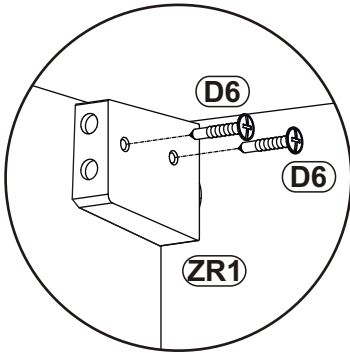

ZR1		D6	
x2		x4	USØ3,5x30

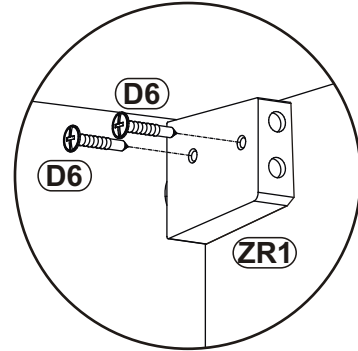

8

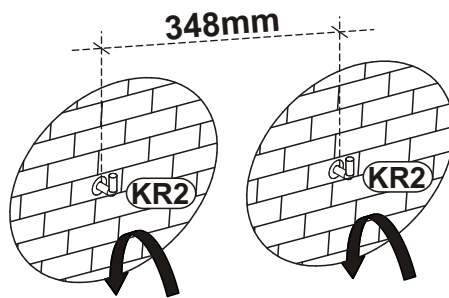
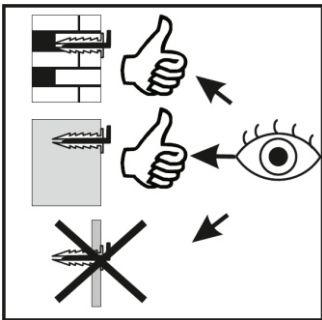

KR2	
x2	

$\phi 8$ KR2 1

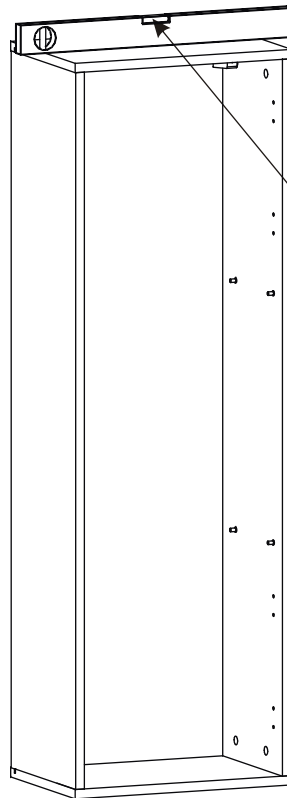
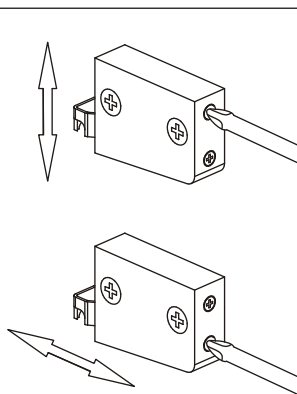
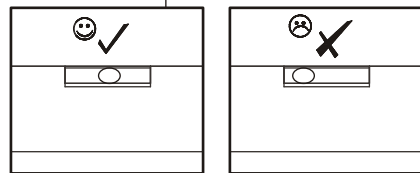
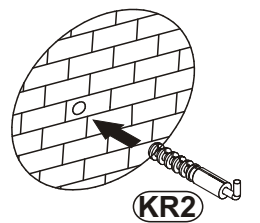
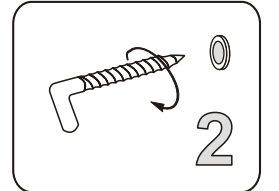
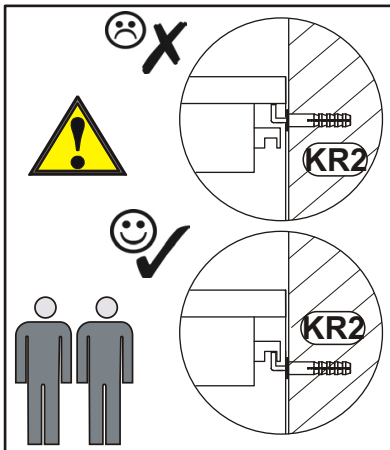

9-10

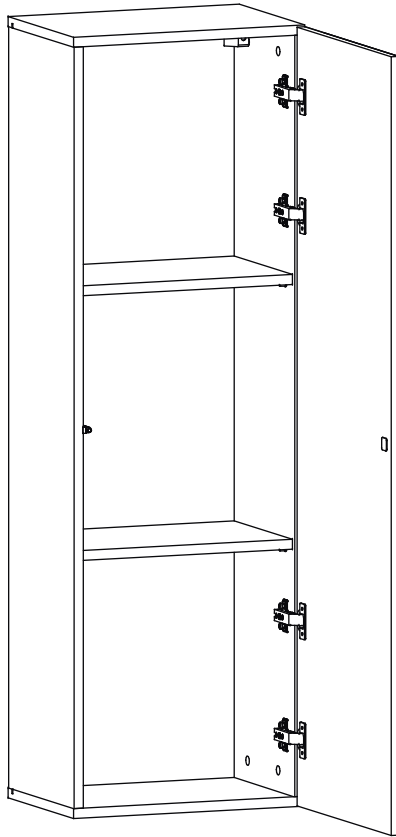

11-12

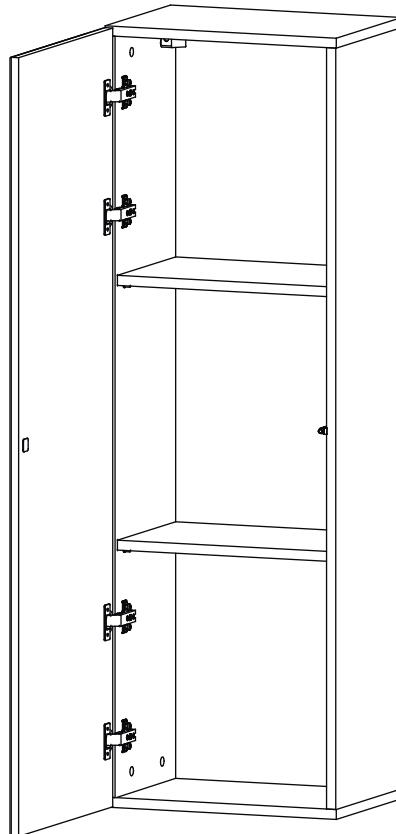

9

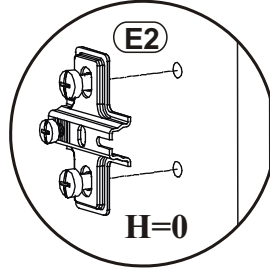
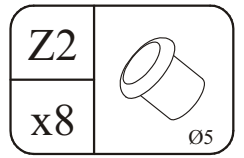
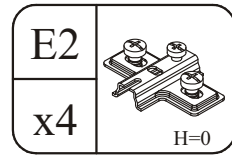
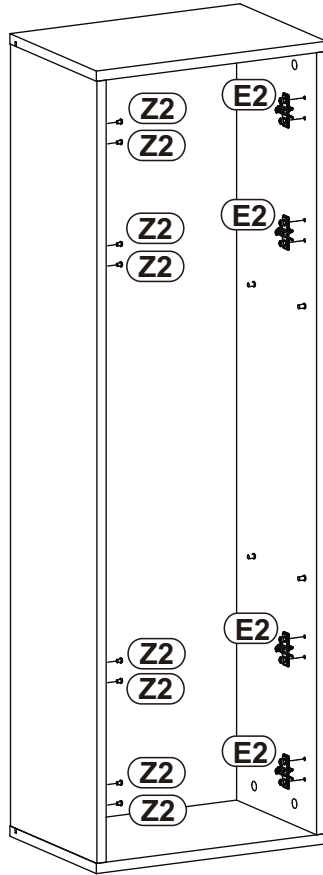
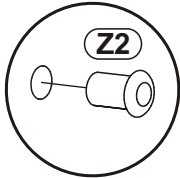
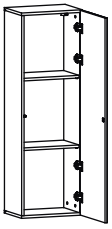

10

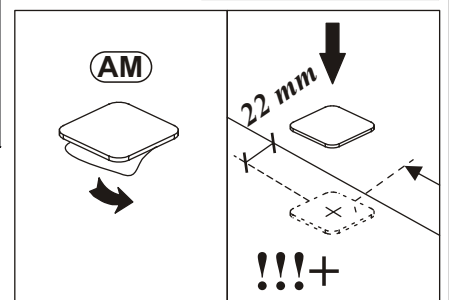
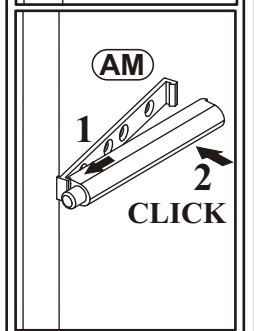
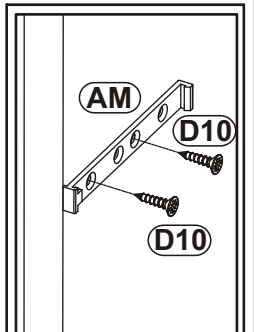
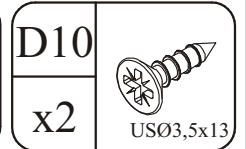
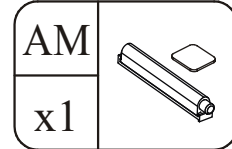
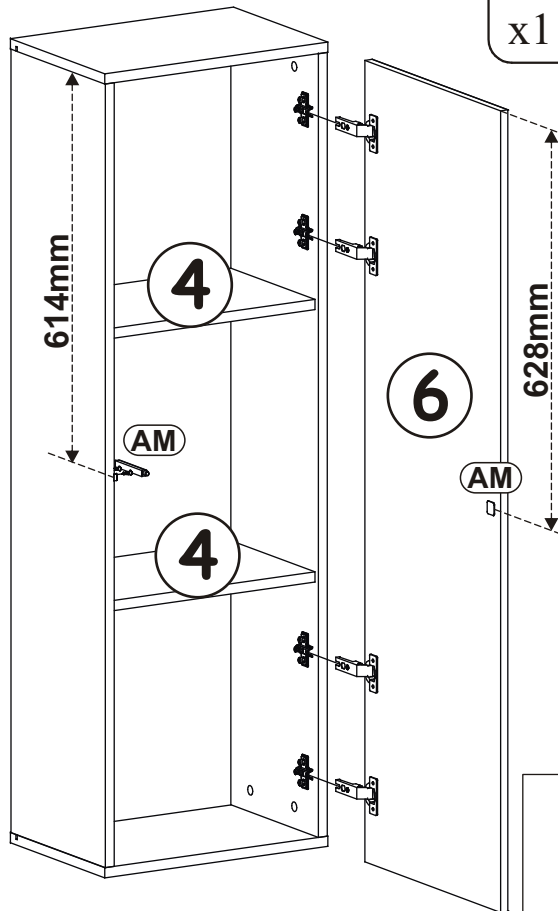
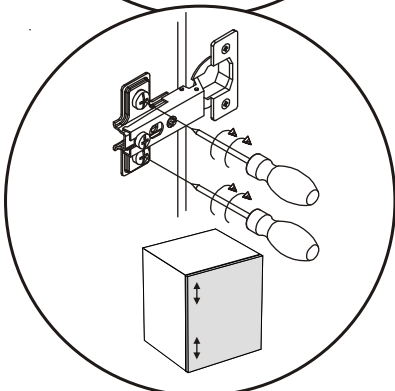
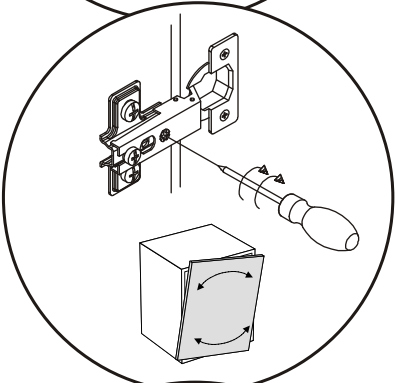
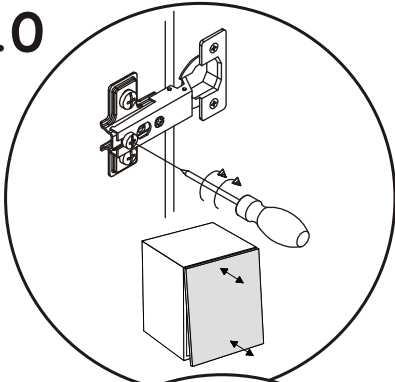

11

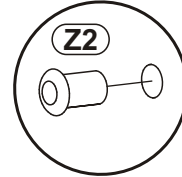
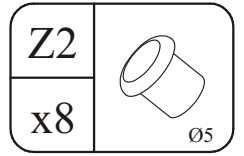
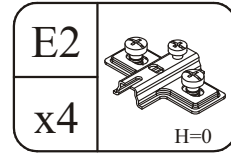
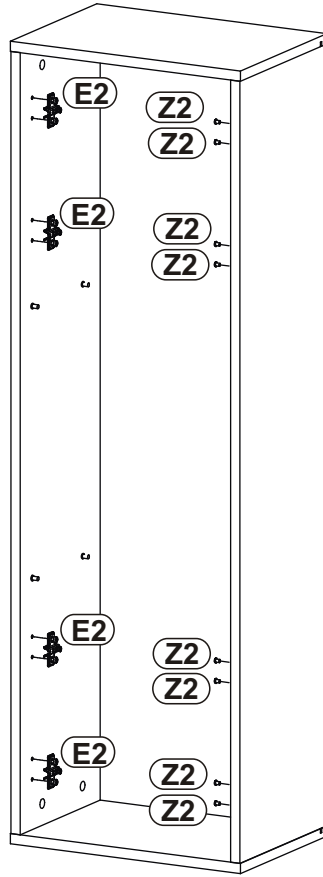
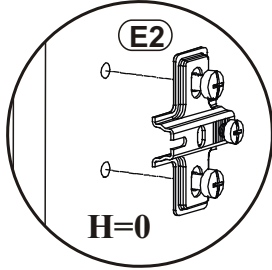
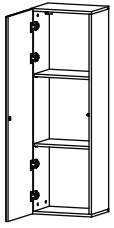

12

