

MONTALE

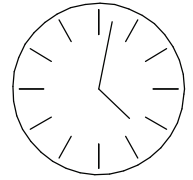

50 min

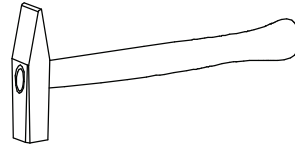

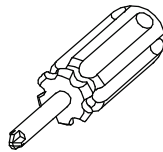
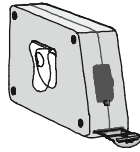
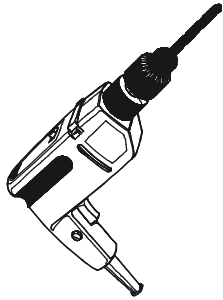
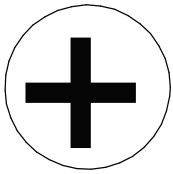
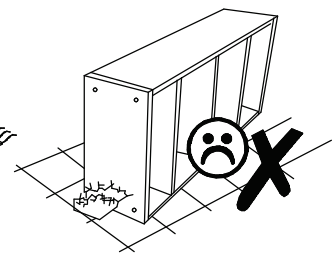
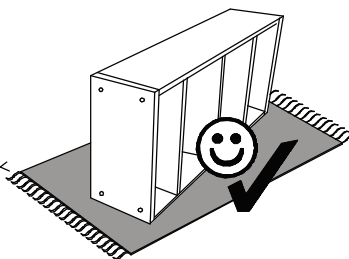
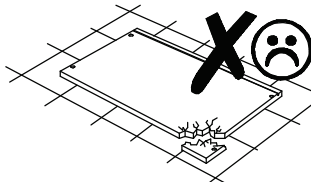
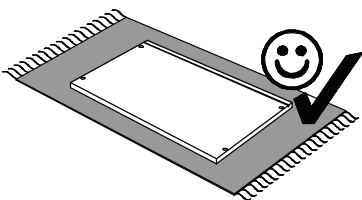
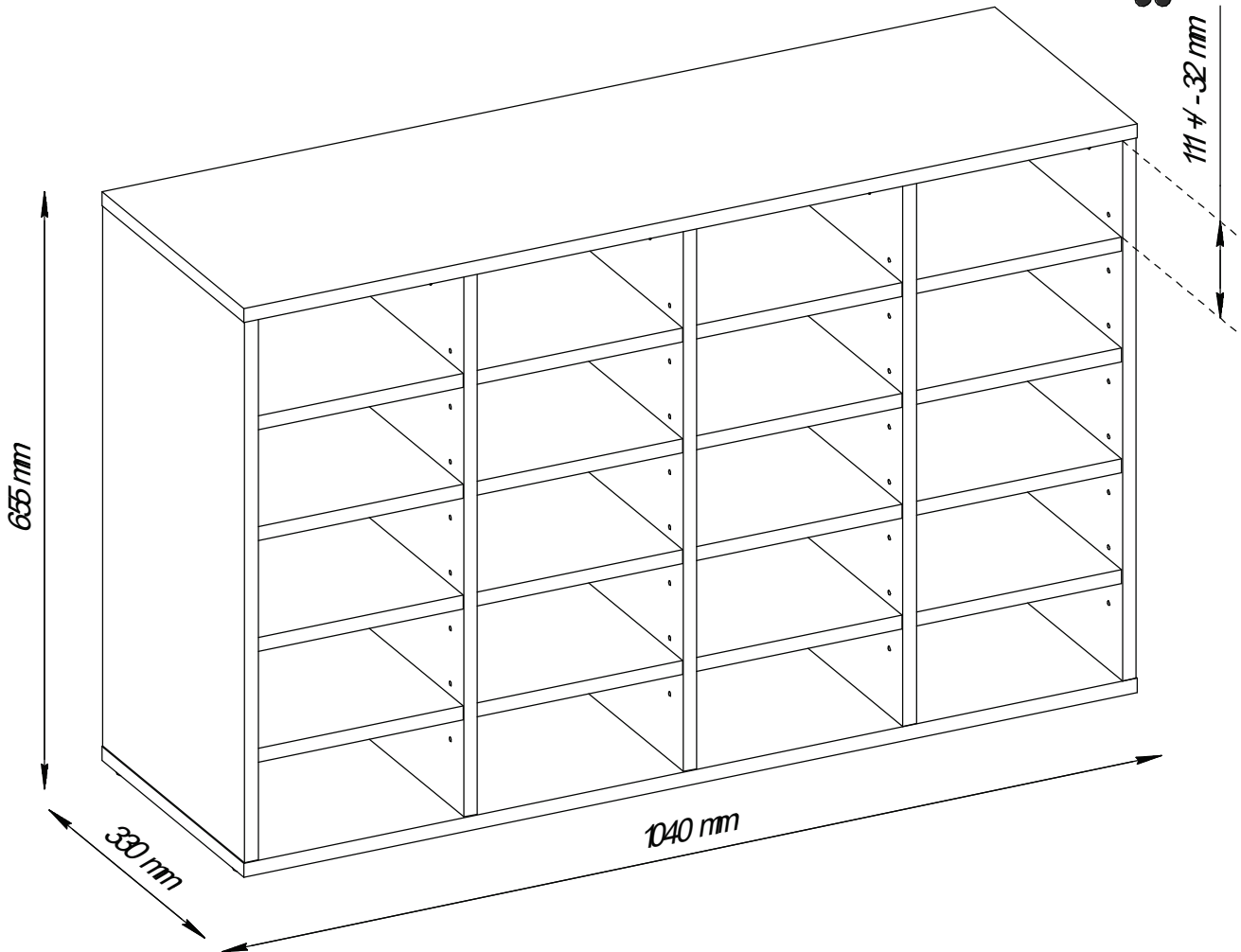
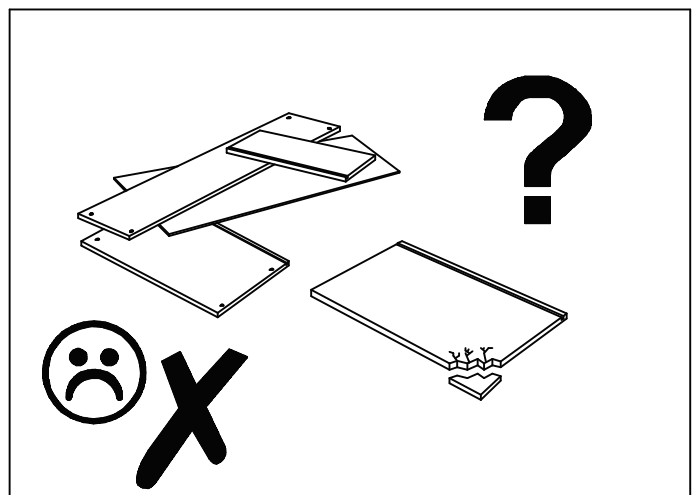
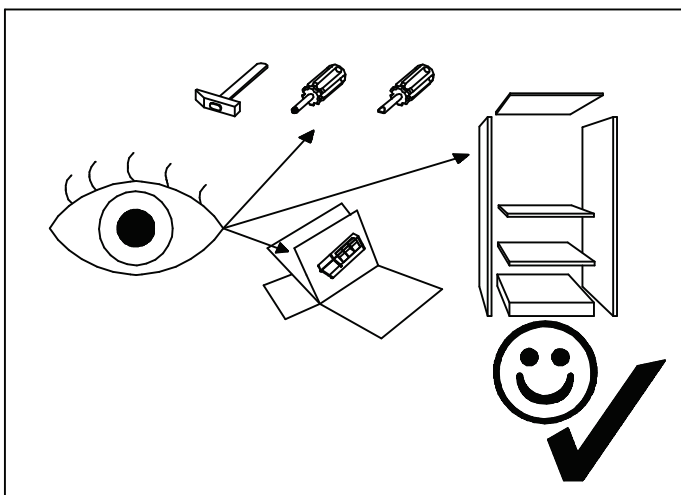
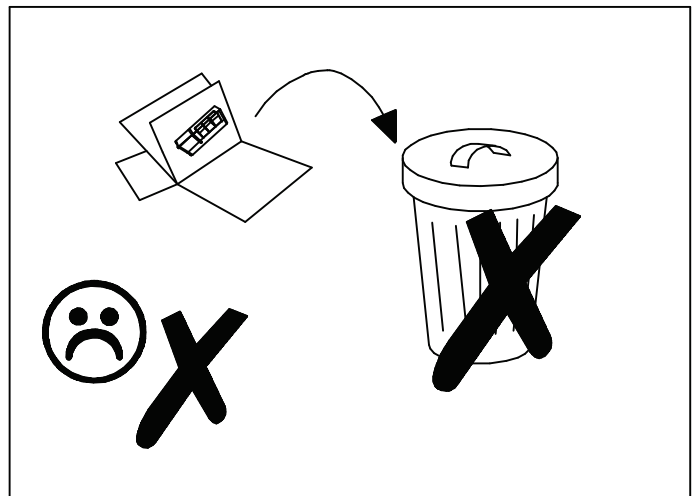
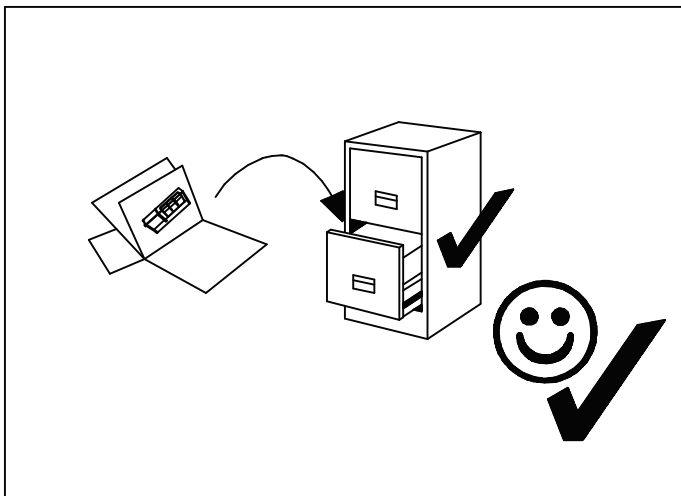
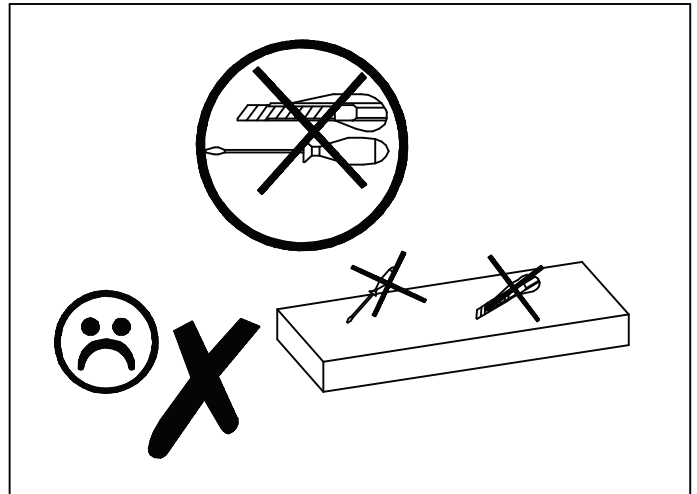
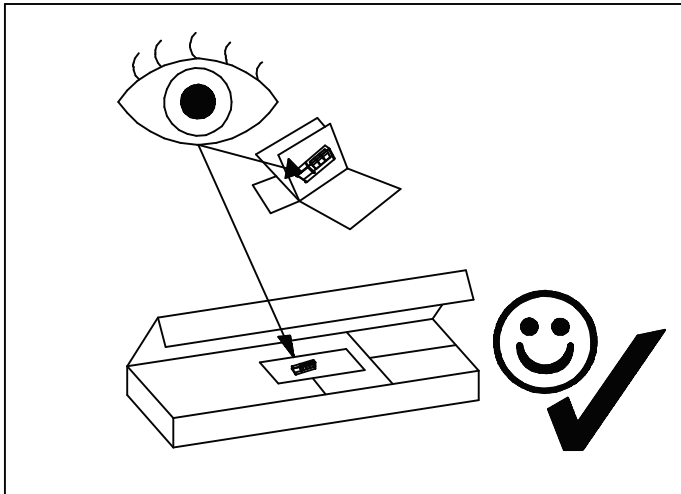

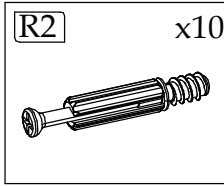
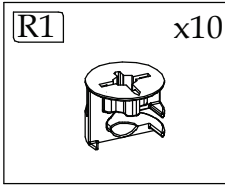
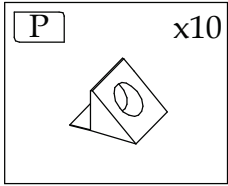
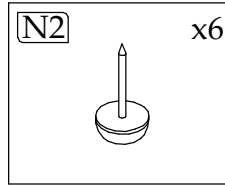
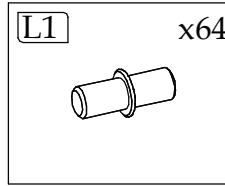
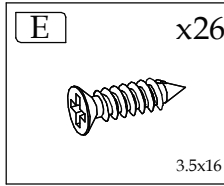
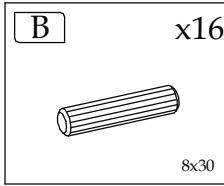
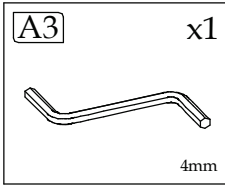
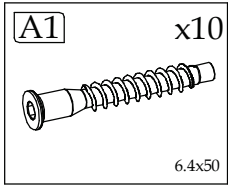

Element symbol	Measurements				Code	Paket
1	1040	330	16	1	1004	1/2
2	618	329.5	16	1	1001	1/2
3	618	329.5	16	1	1002	1/2
4	618	308.5	16	3	1026/1027/1036	2/2
5	1040	330	16	1	1003/2003	1/2
6	239.5	307.5	16	16	N/A	1_2/2
7	1020	316	3	2	1040_v	1/2

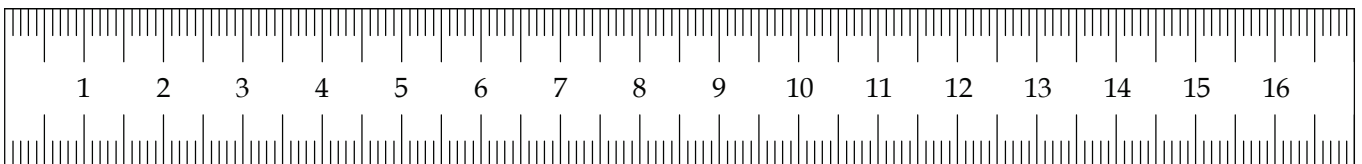
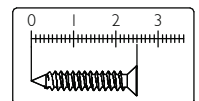
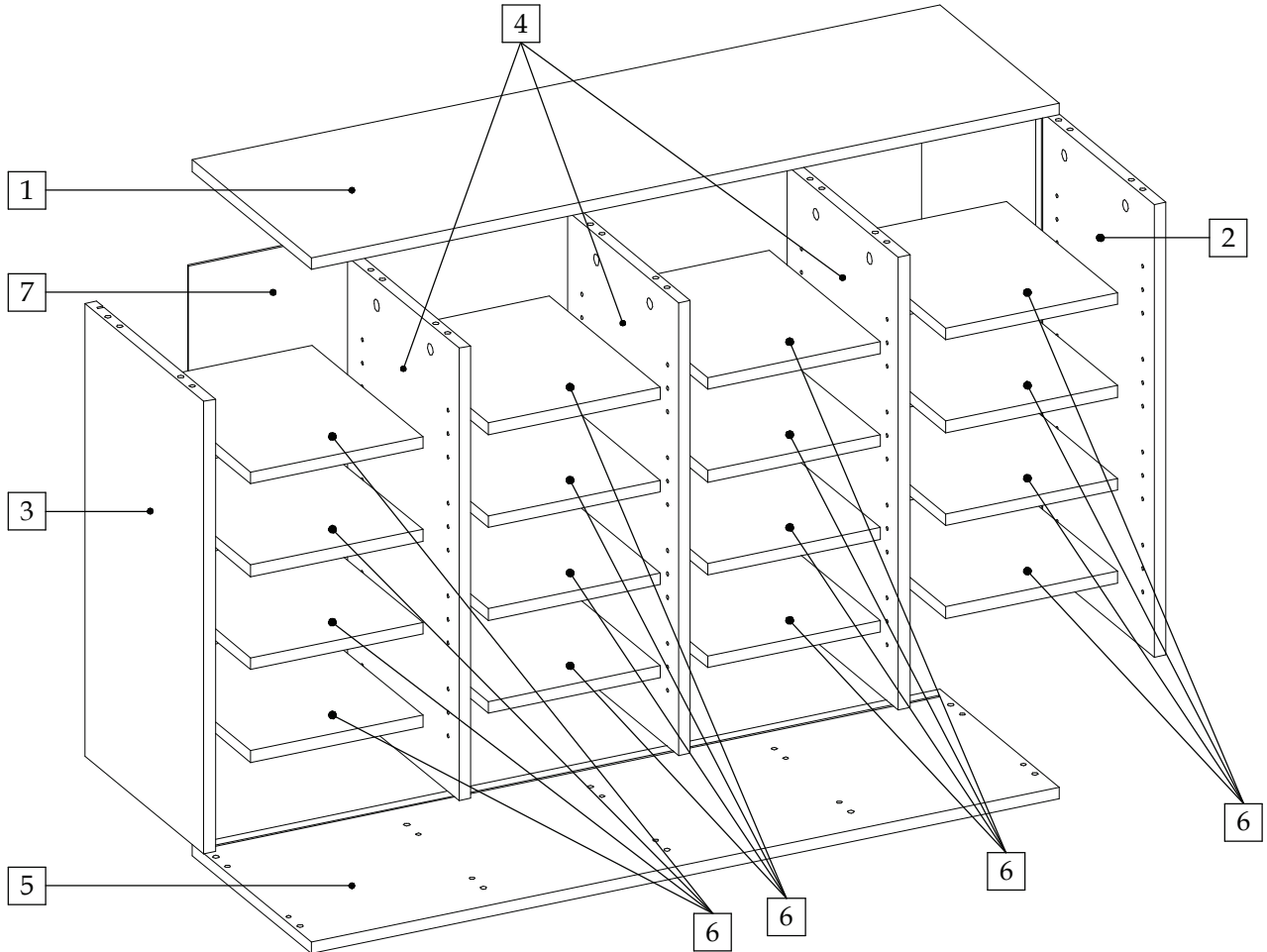
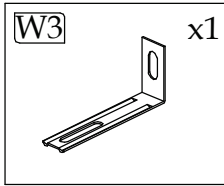
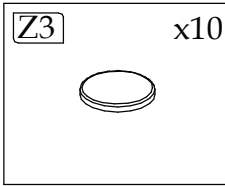
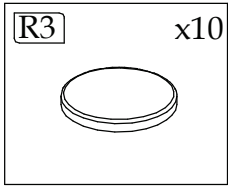

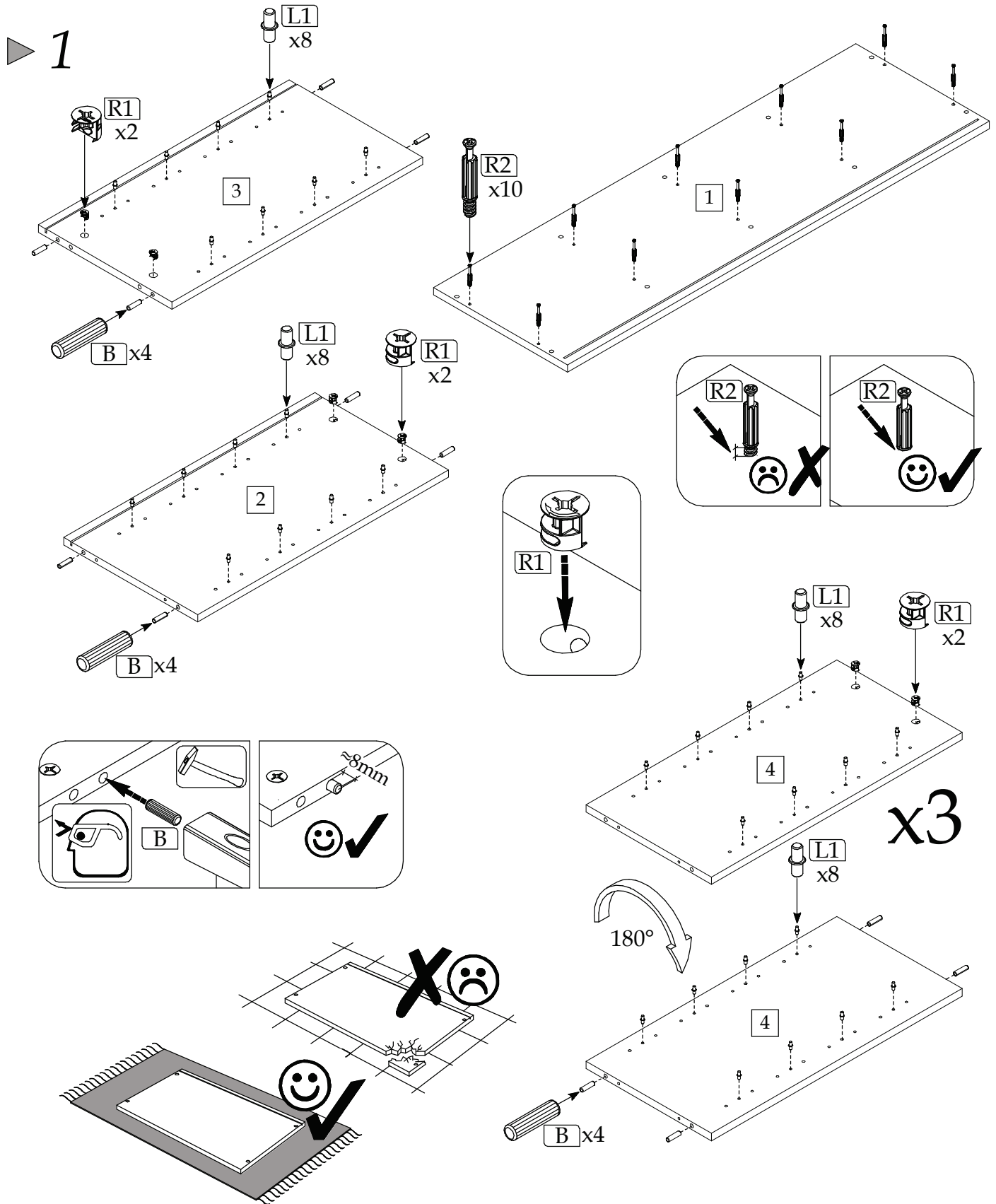
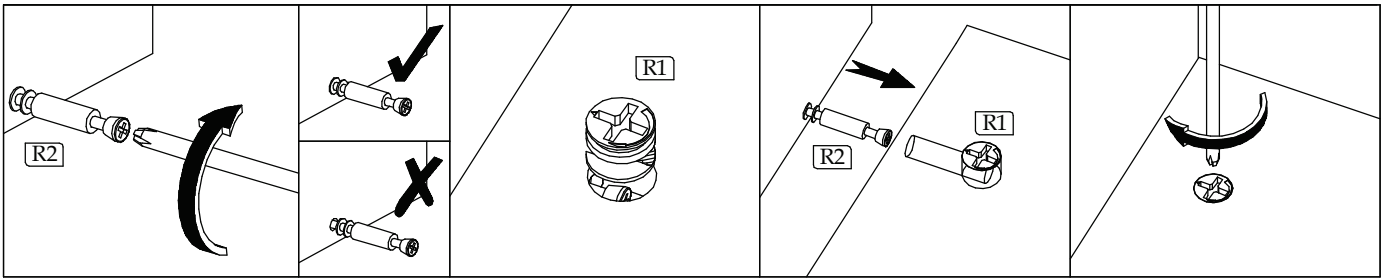

▶ 2

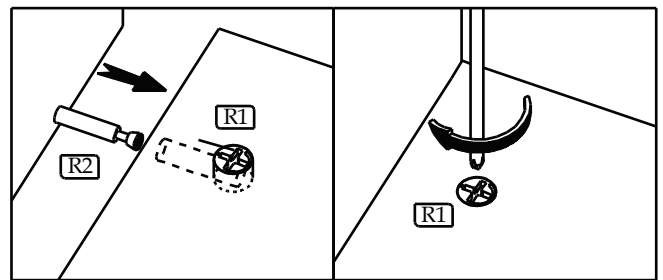
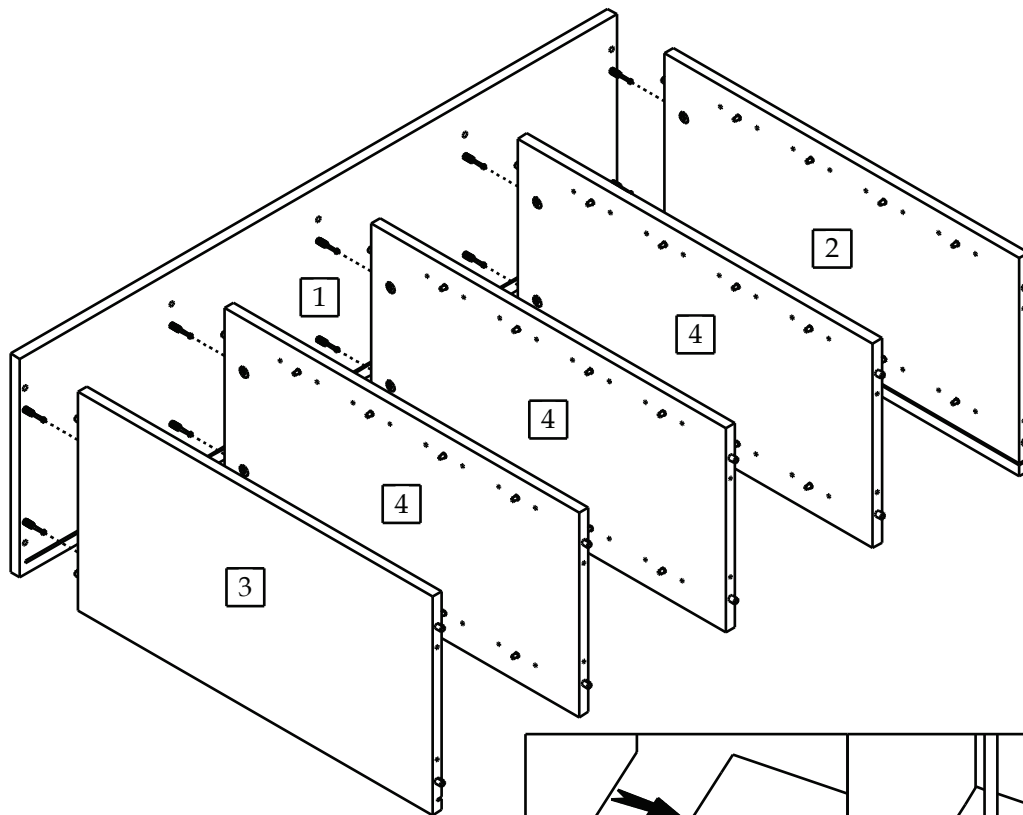

▶ 3

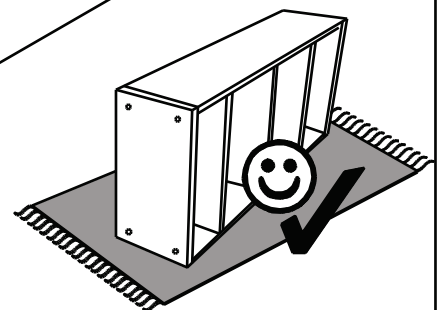
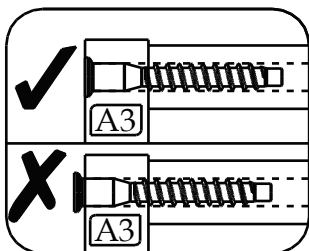
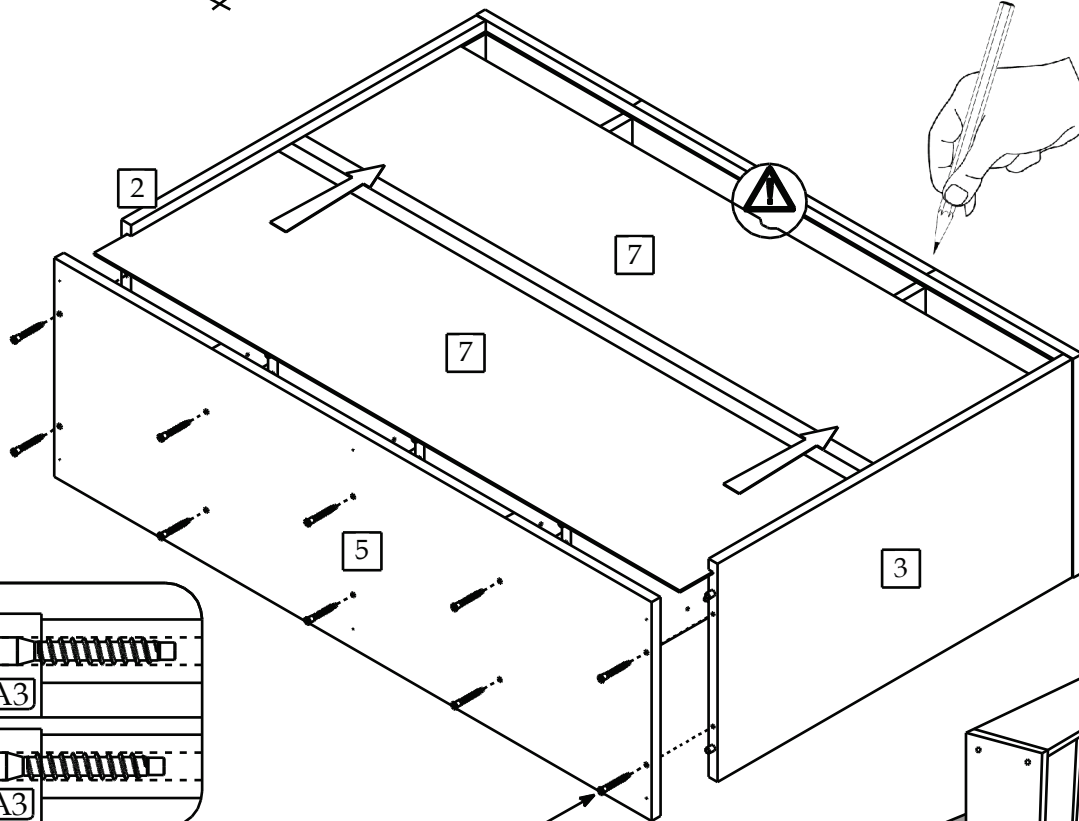
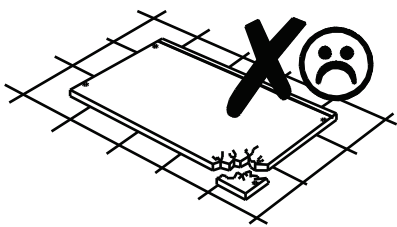

▶ 4

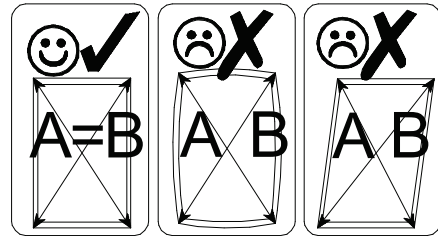
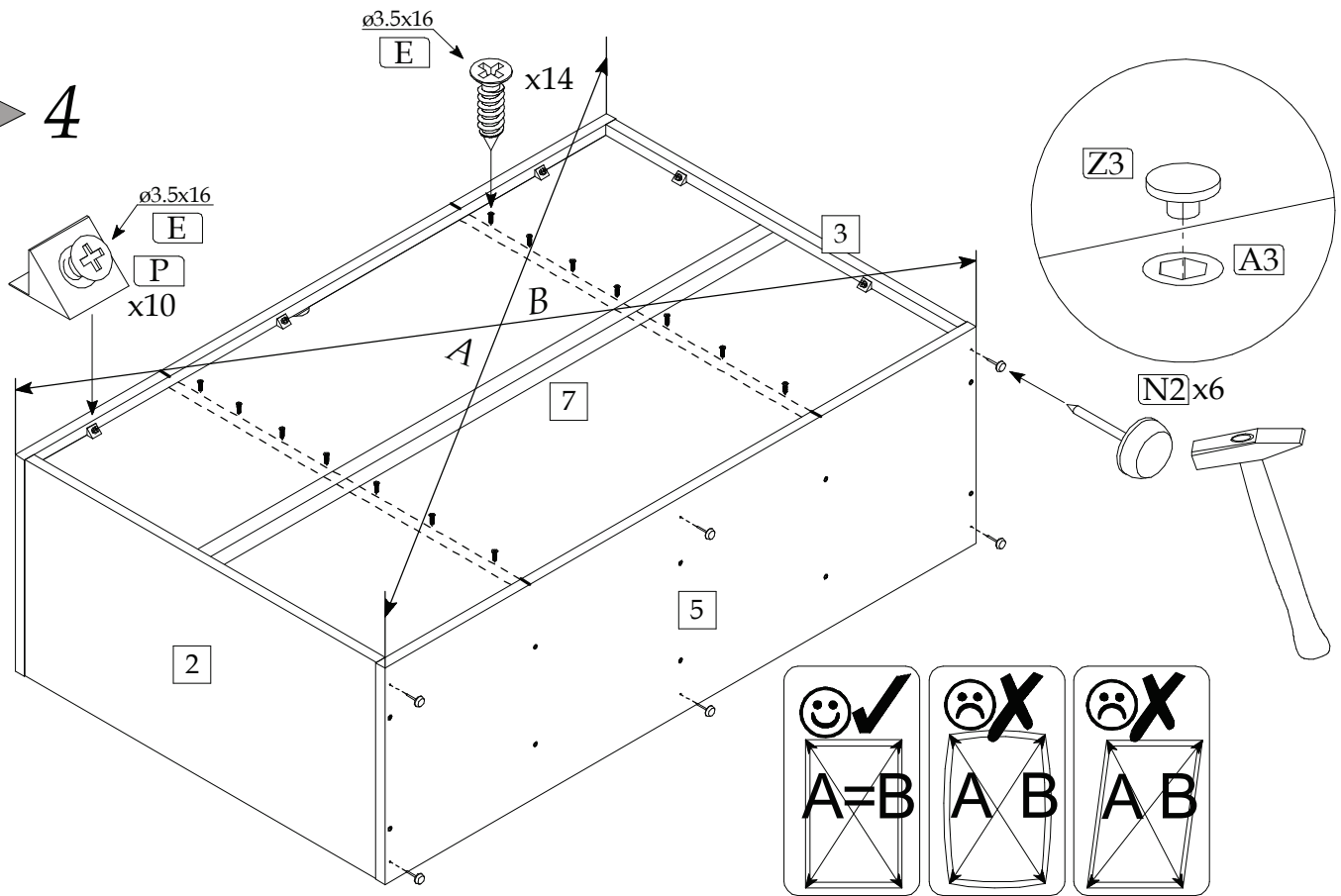

▶ 5

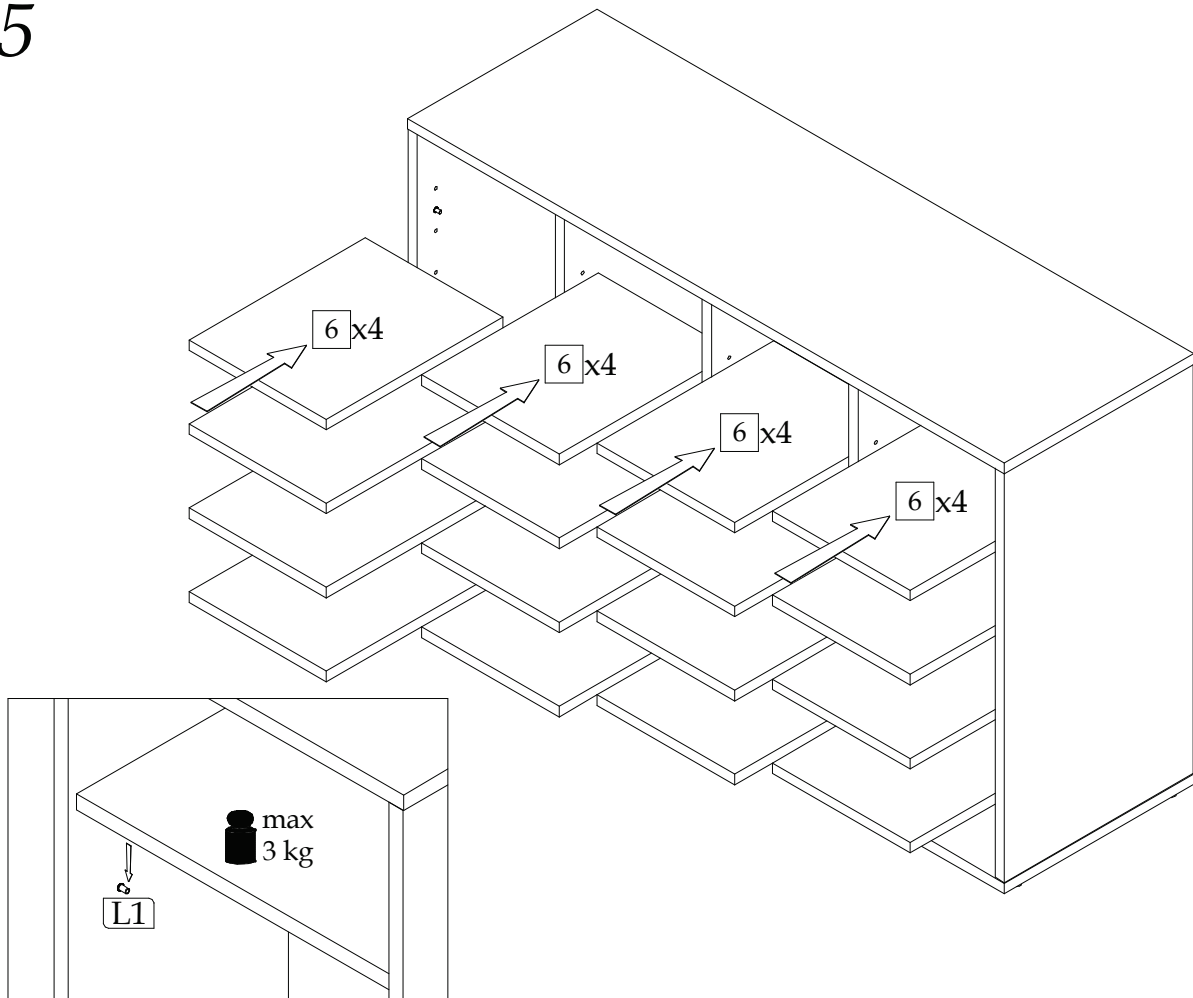

▶ 6

