

# PRINC

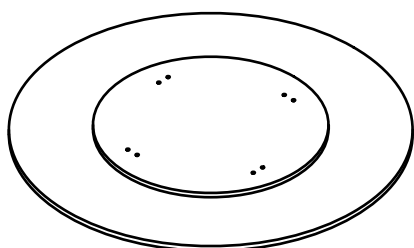

① x 1

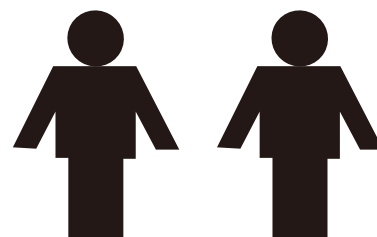
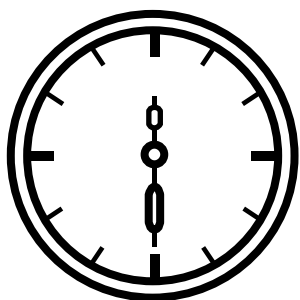
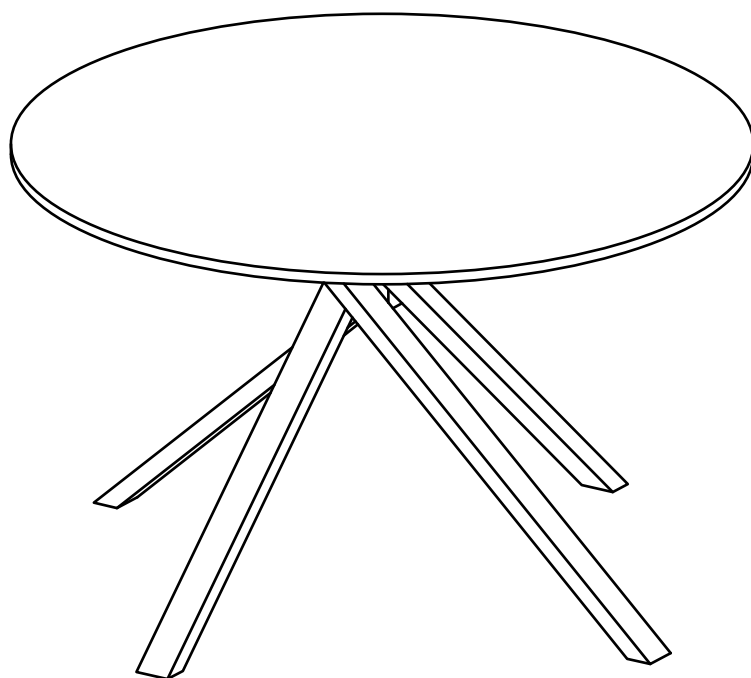
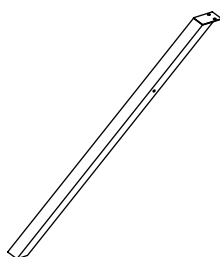

② x 4

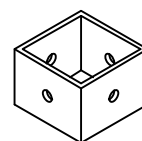

③ x 1

A (M8 × 20mm) × 12

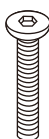

B (M8 × 18mm) × 12



C (M5) × 1



D (M8 × 10mm) × 4



1

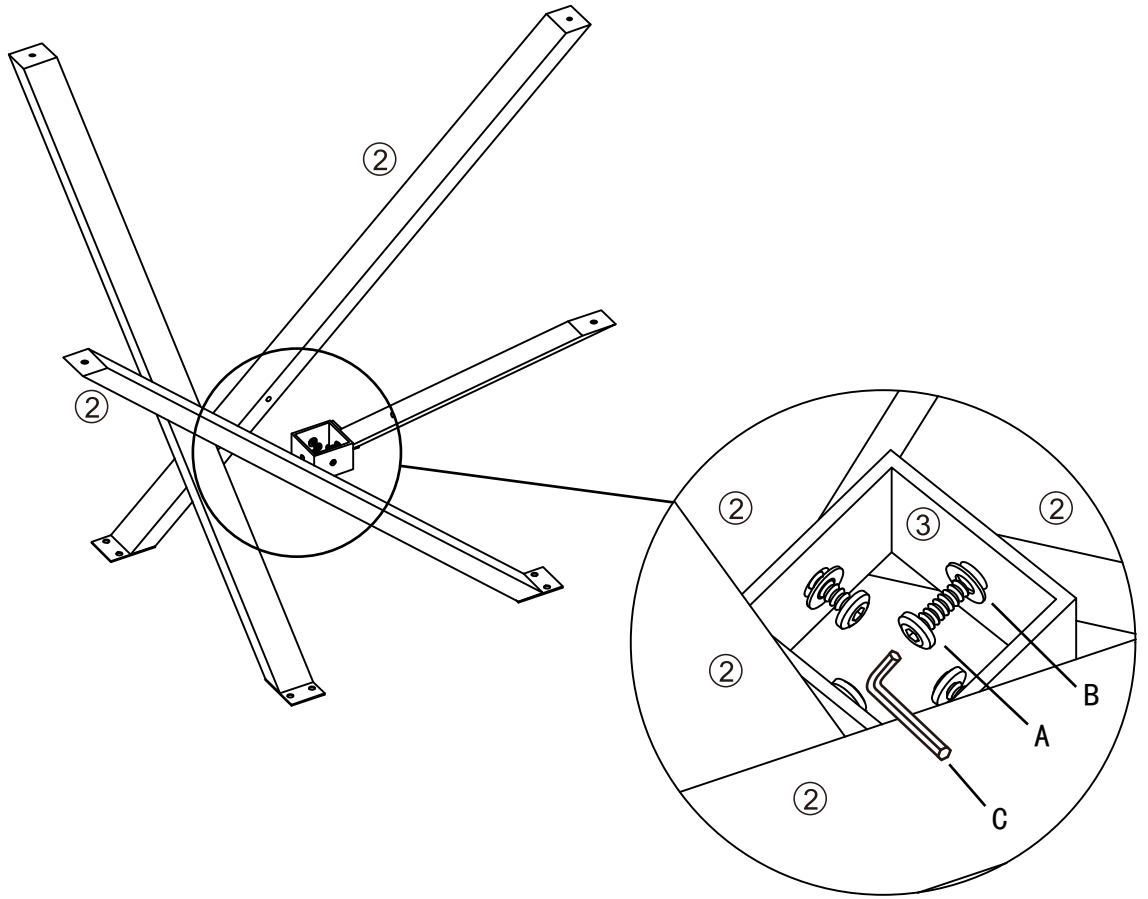

2

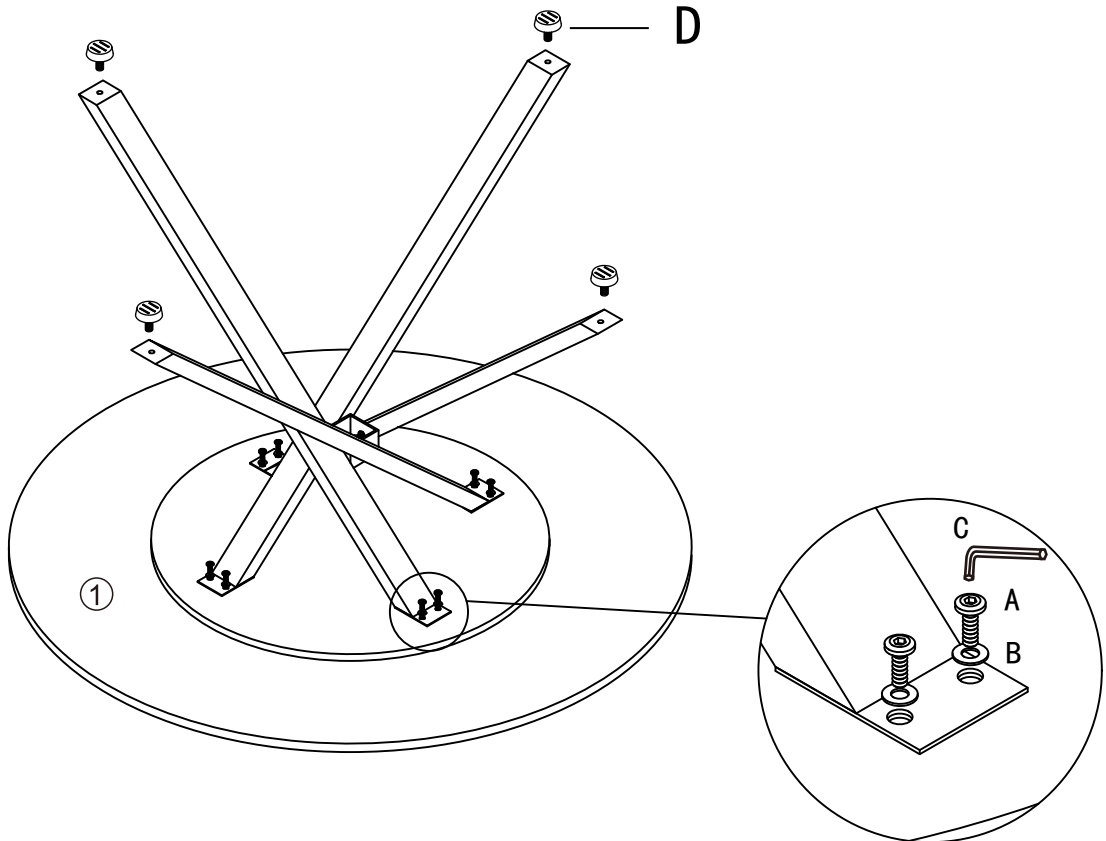

3

